



OPERATING MANUAL

MODEL 3582A SPECTRUM ANALYZER

Serial Numbers: 1747A00101 and greater

WARNING

To help minimize the possibility of electrical fire or shock hazards, do not expose this instrument to rain or excessive moisture.

Manual Part No. 03582-90000

Microfiche Part No. 03582-90050

Copyright Hewlett-Packard Company 1978
P.O. Box 301, Loveland, Colorado 80537

Printed: March 1978

HEWLETT  PACKARD

CERTIFICATION

Hewlett-Packard Company certifies that this instrument met its published specifications at the time of shipment from the factory. Hewlett-Packard Company further certifies that its calibration measurements are traceable to the United States National Bureau of Standards, to the extent allowed by the Bureau's calibration facility, and to the calibration facilities of other International Standards Organization members.

WARRANTY AND ASSISTANCE

This Hewlett-Packard product is warranted against defects in materials and workmanship for a period of one year from the date of shipment, except that in the case of certain components, if any, listed in Section I of this operating manual, the warranty shall be for the specified period. Hewlett-Packard will, at its option, repair or replace products which prove to be defective during the warranty period provided they are returned to Hewlett-Packard, and provided the proper preventive maintenance procedures as listed in this manual are followed. Repairs necessitated by misuse of the product are not covered by this warranty. **NO OTHER WARRANTIES ARE EXPRESSED OR IMPLIED, INCLUDING BUT NOT LIMITED TO THE IMPLIED WARRANTIES OF MERCHANTABILITY AND FITNESS FOR A PARTICULAR PURPOSE. HEWLETT-PACKARD IS NOT LIABLE FOR CONSEQUENTIAL DAMAGES.**

If this product is sold as part of a Hewlett-Packard integrated instrument system, the above warranty shall not be applicable, and this product shall be covered only by the system warranty.

Service contracts or customer assistance agreements are available for Hewlett-Packard products.

For any assistance, contact your nearest Hewlett-Packard Sales and Service Office. Addresses are provided at the back of this manual.

HEWLETT **hp** PACKARD

SPECTRUM ANALYZER

0.02 Hz to 25.5 kHz

MODEL
3582A

← HP-IB →

TECHNICAL DATA APRIL 1978

DUAL-CHANNEL, REAL-TIME SPECTRUM ANALYSIS AND TRANSFER FUNCTION MEASUREMENTS

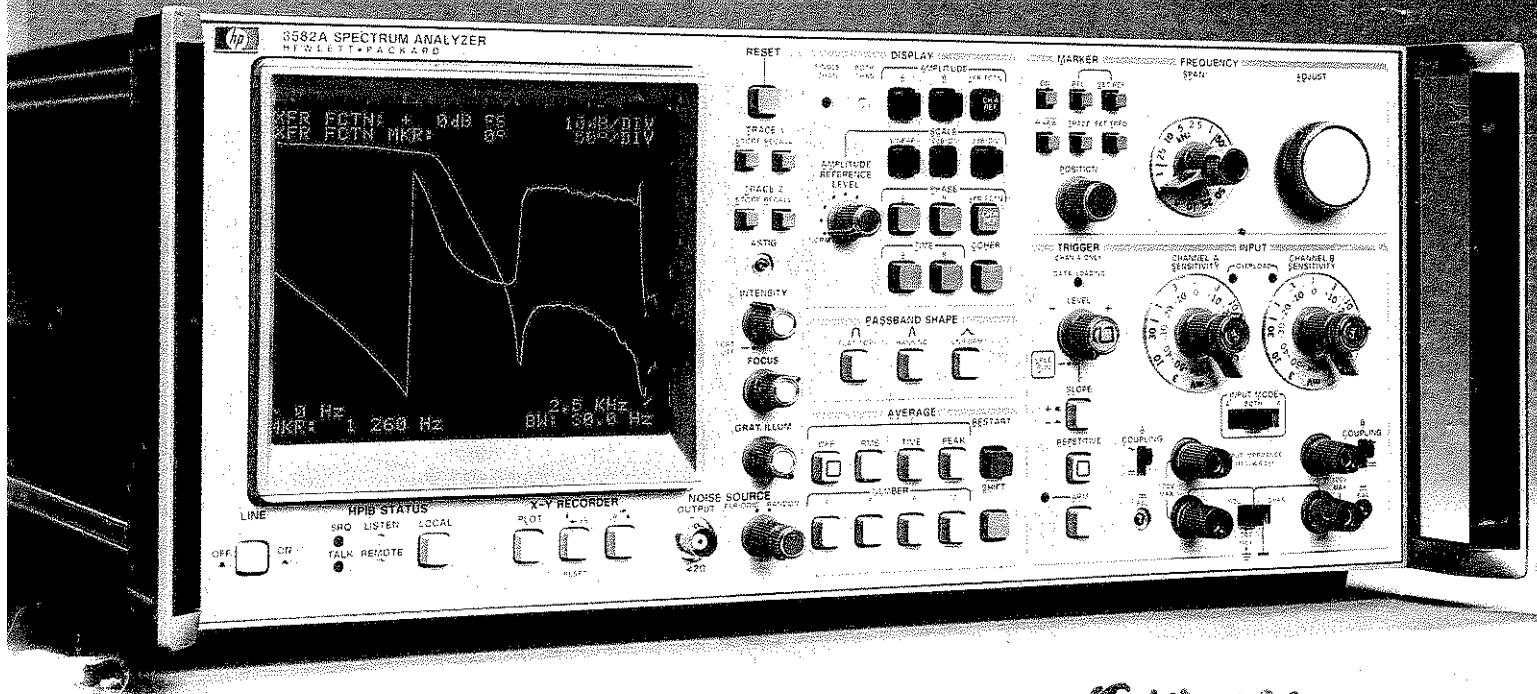

15/10,000
+ INVERTER

THE HEWLETT-PACKARD MODEL 3582A SPECTRUM ANALYZER CAN HELP YOU . . .

. . . improve research and development results by . . .

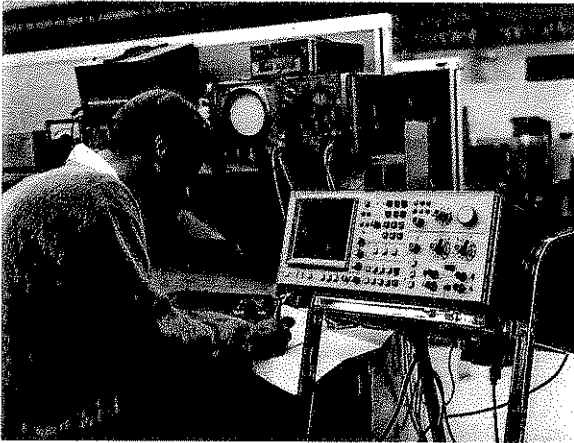

- . . . providing powerful new measurement capabilities such as the phase spectrum, transfer function, coherence function and transient analysis. These can lead to significant new design insights and improvements.
- . . . making conventional spectrum measurements faster and easier than ever before. This makes it possible to devote more time to the creative aspects of the design process and less to testing and verification.

. . . reduce production costs by . . .

- . . . making frequency domain measurements one to two orders of magnitude faster than a conventional swept analyzer. These reduced measurement times result in increased production throughput.
- . . . allowing you to devise an HP-IB based system to automate production testing. Automated testing results in reduced test time per unit and increased confidence in the quality of the final product.

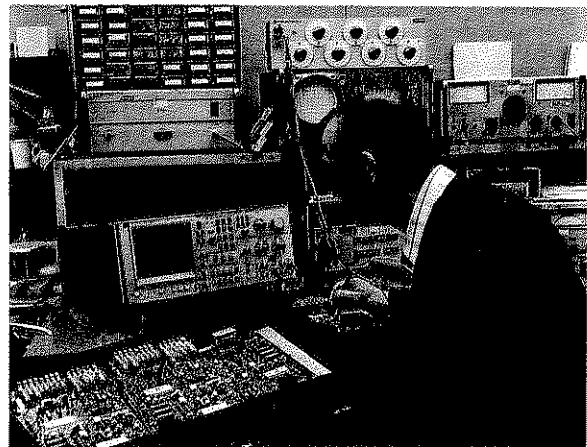

. . . optimize maintenance efficiency by . . .

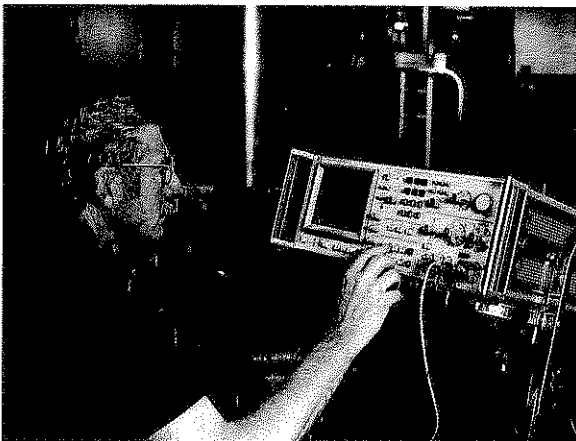

- . . . providing an HP-IB based method of storing and processing periodic maintenance data such as rotating machinery signatures. This capability makes it possible to more precisely formulate a test and repair strategy.
- . . . allowing more precise, repeatable measurements of the maintenance parameters of interest and by providing new diagnostic tools such as the coherence function. This makes it possible to identify subtle but significant problems in time to take the appropriate action.

HP MODEL 3582A REAL TIME SPECTRUM ANALYZER

The HP 3582A Real Time Spectrum Analyzer is a unique instrument that provides a real-time display of the spectrum of a signal. It is designed for use in a variety of applications, including signal analysis, troubleshooting, and research. The analyzer features a built-in noise source, digital averaging, and triggered operation, making it a versatile tool for signal analysis.

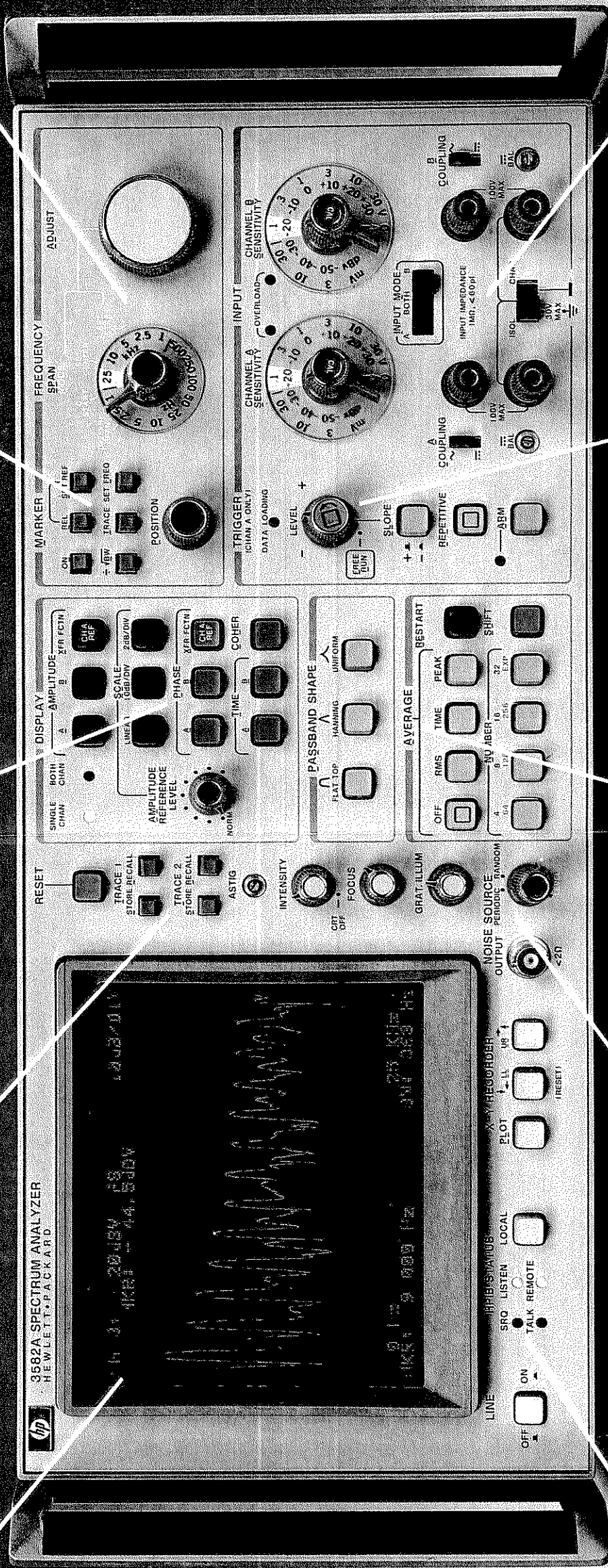

Shown with option 907 handles.

remote HP-IB* operation

All major front panel controls can be remotely programmed via the HP-IB and both time and frequency domain data can be input or output over the HP-IB.

built-in noise source

The built-in noise source provides a flat "tracking generator" type signal that can be used to drive a device under test in network analyzer type applications.

digital averaging

Several different digital averaging modes can significantly improve the quality and accuracy of measurements of random noise or signals in the presence of random noise.

triggered operation

Triggering on the input signal or external triggering makes it possible to capture and analyze transient phenomena that last for only a few milliseconds.

dual input channels

Both input channels can operate simultaneously, allowing independent signals to be examined for common characteristics.

*The HP-IB is Hewlett-Packard's implementation of IEEE Standard 488 and ANSI Standard MC1.1.

FEATURES

Resolve Closely Spaced Signals With Powerful Band Analysis Capability

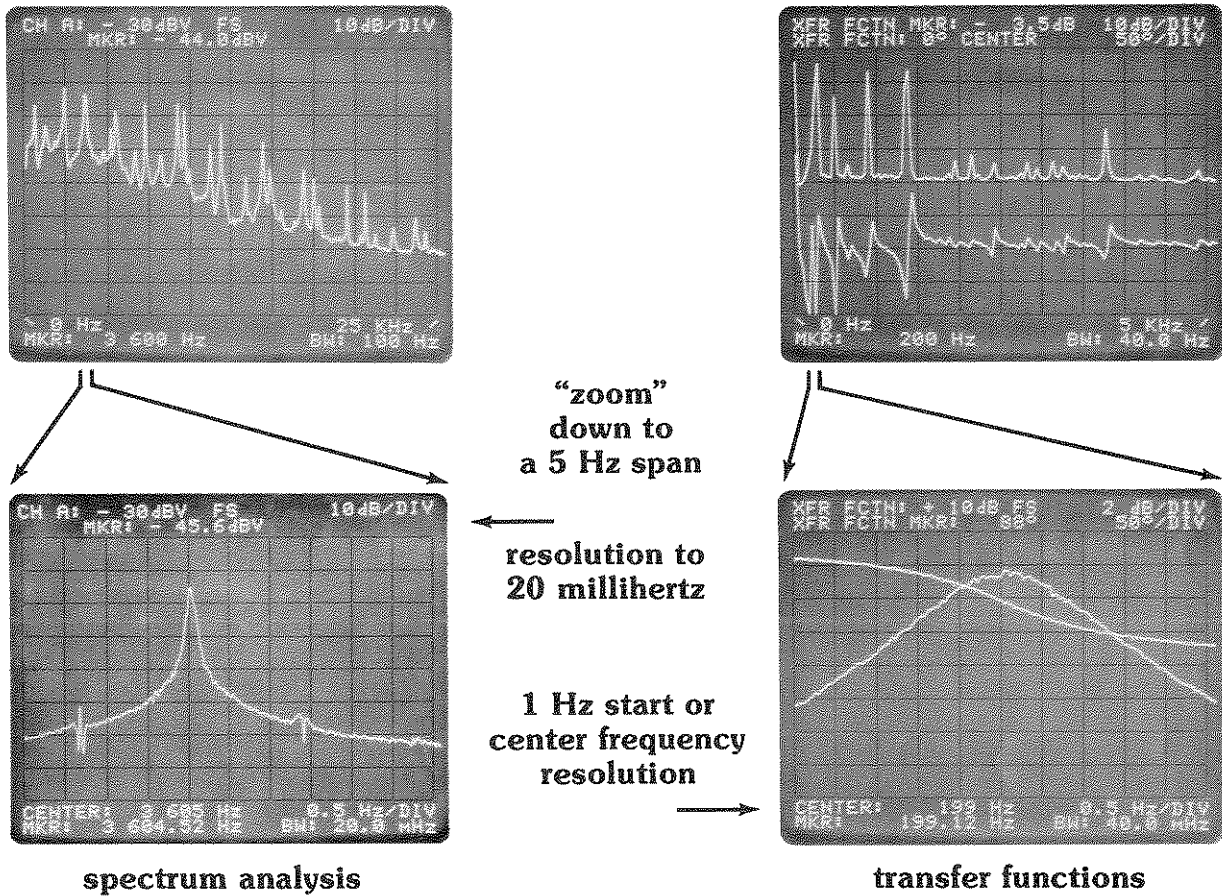

The ability to resolve closely spaced spectral components is often critical in the study of subtle phenomena such as structural transfer functions. Unlike conventional digital signal analysis which extends from DC to some maximum frequency, the Model 3582A can "zoom in" to analyze any selected band of frequencies with dramatically improved resolution. The start or center frequency

of the 5 Hz to 25 kHz band analysis spans can be adjusted in 1 Hz increments to cover the entire frequency range of the instrument. This provides resolution down to 20 milliHertz across the entire range for spectrum analysis or 40 milliHertz for transfer functions, representing as much as a 5000 to 1 improvement over conventional "baseband" analysis.

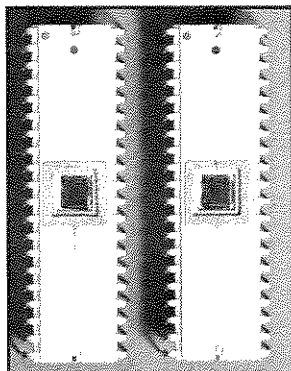

Four single chip LSI digital filters make this powerful band selectable analysis capability possible. They provide the large number of high quality filters that are required. This is only one of several examples in the Model 3582A where HP technology provides significant new capability while still maintaining a low cost.

Measure Signals Over More Than Six Decades Of Frequency Range

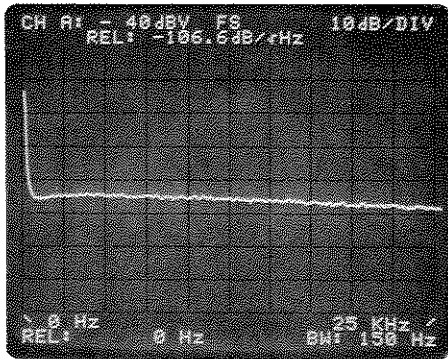

←
25.5 kHz

to 20 millihertz

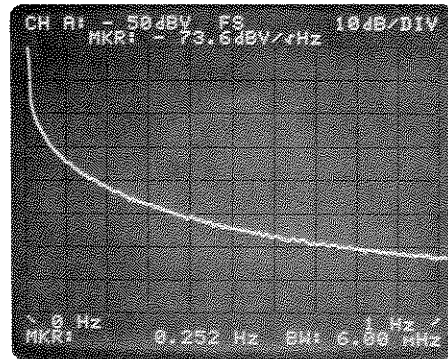

Many electrical and physical measurements such as mechanical vibrations, biomedical responses and seismic events have significant spectral information in the audio and sub-audio range. With frequency ranges from 25 kHz down to 1 Hz full scale, the Model 3582A is extremely well suited to these types of measurements. The

displays shown represent the phase noise of a frequency synthesizer output. Note that one of these examples covers the range of 0 to 1 Hz with a frequency resolution of only 6.00 milliHertz. High resolution sub-audio measurements such as this are impossible with a swept analyzer, but are routine with the Model 3582A.

Wide Calibrated Amplitude Range Minimizes External Signal Conditioning

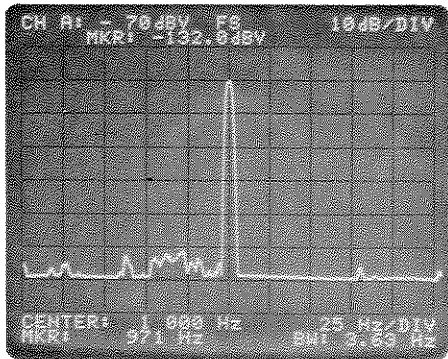

→
+ 30 dBv
down to

- 120 dBv
noise level

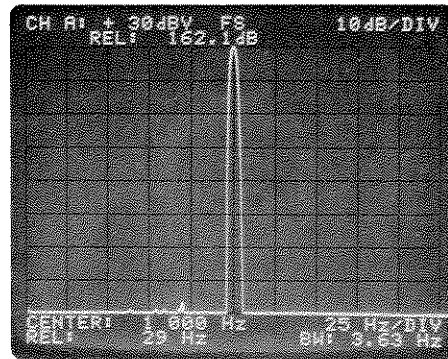

When examining the sensitivity of an analyzer, it is important to consider the full range of potential applications. Many amplifiers have output signals that are well over 20 volts while many electronic signals and transducer output signals are in the millivolt range. If the analyzer does not directly cover the range of anticipated signals, external amplifiers or attenuators will be required. These devices can add their own noise and can distort the signal being measured. The Model 3582A offers 150 dB

of calibrated measurement range covering +30 dBV (31.6 volts) to -120 dBV (1 μ volt) and thus minimizes the need for external signal conditioning. Even with input sensitivities down to -120 dBV the input circuit is fully protected against accidental overloads of 100 Volts DC or 120 Volts RMS for short periods. This protection can significantly reduce accidental down time and the overall cost of ownership, particularly in harsh operating environments.

"Real-Time" Measurement Speed Minimizes Testing Time

Long measurement times can be a major limitation of swept low frequency spectrum analyzers. In high volume testing or in applications requiring substantial on-line tuning these long measurement times are both expensive and inconvenient. Since the Model 3582A uses an advanced microcomputer to execute the Fast Fourier Transform (FFT), it can perform equivalent measurements as much as one to two orders of magnitude faster than a swept analyzer.

This high speed measurement capability makes the Model 3582A well suited to production type tuning and adjustment procedures.

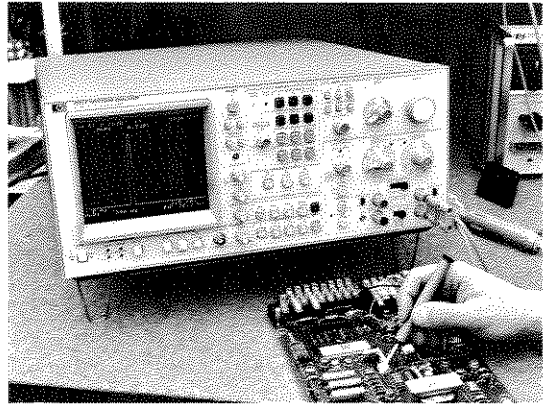

Characterize Random Signals With Precise, Repeatable Digital Averaging

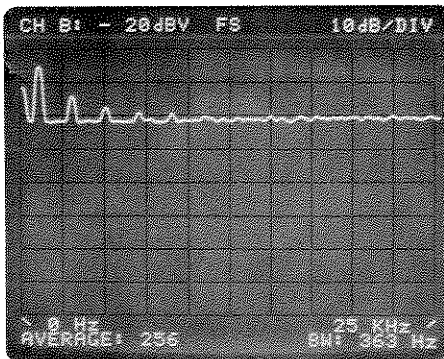

RMS average



time average

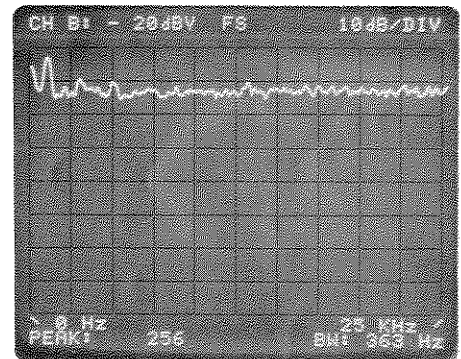

peak hold

Many spectral measurements contain both discrete signals and random noise components. Obtaining proper amplitude readings can be difficult if the random components are really the ones of interest or are of nearly the same amplitude as the discrete signals.

The digital averaging techniques incorporated in the Model 3582A help solve these problems. The RMS averaging mode takes the power average of 4 to 256 successive spectra in order to reduce the uncertainty of the estimate of random spectral components. Conceptually, this is equivalent to analog video filtering, but the digital implementation offers greater flexibility and precise, repeatable results with predictable confidence level improvements. For measurements where the spectral information is not stable but varies slowly with time a running exponential form of RMS averaging is provided. By con-

tinually reducing the importance of older spectra, this mode prevents old data from completely obscuring new data yet still retains the basic advantages of averaging.

The digital RMS average, like video filtering, smooths the random components but does not provide actual signal-to-noise enhancement. When a synchronizing trigger signal is available, the TIME average can enhance the signal-to-noise ratio by as much as 24 dB. Since it involves the averaging of successive time records before transformation it is also significantly faster than other types of averaging.

The displays shown compare each major type of averaging on a mixture of random and discrete signals.

Application Note 245-1, titled "Signal Averaging with the HP 3582A Spectrum Analyzer," discusses averaging in more detail.

Measure Transfer Function Amplitude And Phase Directly

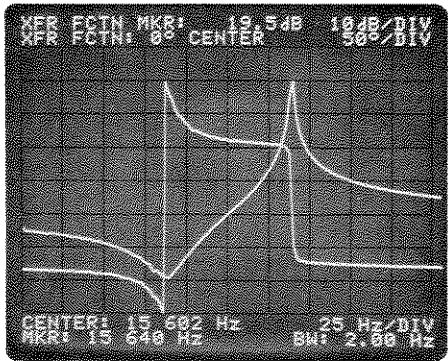

network analysis

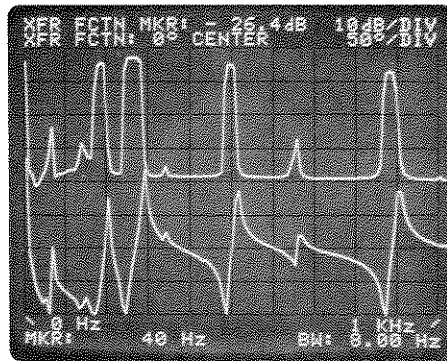

mechanical
transfer functions

Many electrical circuits and mechanical systems can be treated as linear networks and can be characterized by the magnitude and phase of their transfer functions.

Most spectrum analyzers can measure only the magnitude portion of the transfer function—and even then only by assuming a flat drive signal. The Model 3582A directly measures the complete transfer function, both magnitude and phase. With dual channels the actual drive signal is measured on Channel A and thus does not have to be totally flat; drive signal variations are taken out in the computation process to give valid results. The major constraint on the input signal is that, unlike a swept source, it

must stimulate all frequencies of interest simultaneously. For some applications, true random noise or even impulse signals serve as useful drive signals. In most applications, however, the built-in noise source serves as an ideal input. With this drive signal functioning as a “tracking generator” substitute, the Model 3582A is a low frequency network analyzer with “real-time” measurement speed. As with spectrum measurements, portions of the transfer function as narrow as 5 Hz can be examined anywhere over the 25 kHz frequency range. This minimizes the possibility of missing or improperly measuring high Q electrical or mechanical resonant behavior.

Stimulate Devices With The Internal Noise Source To Obtain Transfer Functions

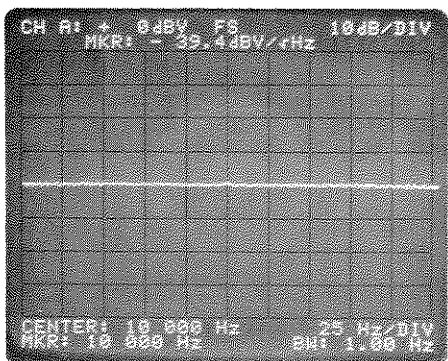

periodic or
random noise

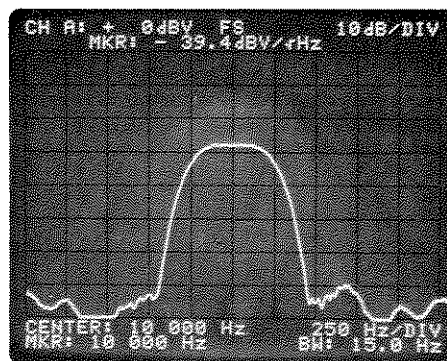

band limited and
band translated

In order to fully utilize the transfer function capability of the Model 3582A, a matched drive source is required. The built-in periodic noise source is the conceptual equivalent of a tracking generator providing a drive signal that is flat to within better than ± 1 dB across the frequency band being measured. The computation of the transfer function takes out even this residual variation. The key advantage of this source is that it is periodic with a period equal to the time record length of the measurement. This means that results don't vary randomly from measure-

ment to measurement and valid measurements can be obtained without averaging. When the true random noise source is used, extensive averaging must be used to achieve statistically reliable results.

The noise source signal is always tailored to the selected measurement frequency. It is automatically band limited to the appropriate span width and translated in frequency to match the analyzer settings as shown. This minimizes the energy applied to any critical portions of the spectrum that are not being measured.

Capture and Analyze Transients That Last For Only A Few Milliseconds

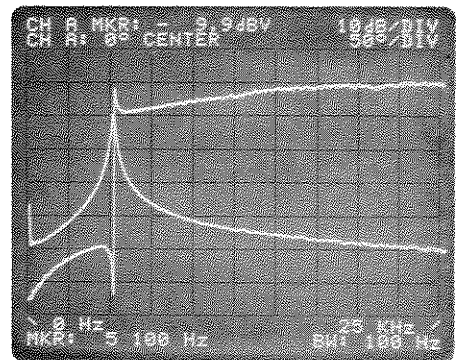
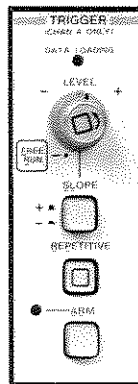
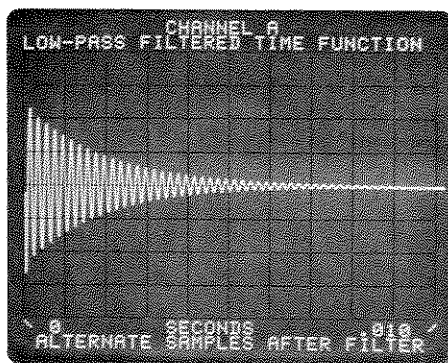

Many signals such as mechanical shocks and electrical transients are relatively uncooperative from a measurement point of view. They may occur infrequently and spontaneously and may last only for a brief period of time. Swept spectrum analyzers generally cannot handle these transient signals. By using digital processing techniques, the Model 3582A can capture and analyze transients as short as a few milliseconds. This means that spectrum analysis and transfer function analysis are no

longer limited to stable, time invariant signals.

Measurements can be initiated by an external trigger pulse or as shown by triggering on the input signal itself. This example illustrates the capture of a 10 millisecond portion of the response of a damped circuit to an impulse. In the frequency domain the nominal ringing frequency of 5100 Hz is clearly evident. Simple marker operations can be used to estimate the damping factor.

Complete the Characterization Of Signals With The Phase Spectrum

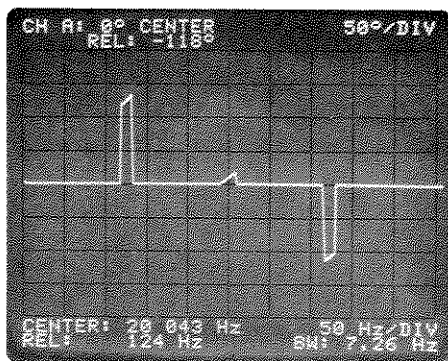

←
**AM sidebands
add to 0° or 180°
from carrier**

**FM sidebands
add to +90° or
-90° from carrier**
→

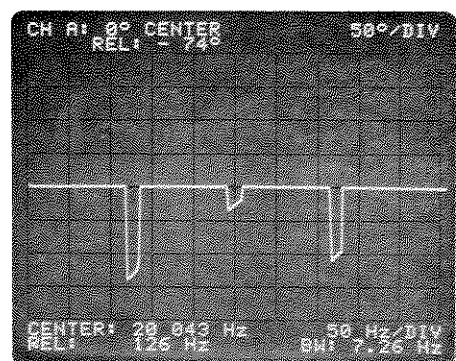

Most spectrum analyzers can measure only the amplitude spectrum of a signal, yet complete characterization in the frequency domain also requires phase information. Signals with identical amplitude spectra, but different phase spectra can differ significantly. The advanced digital signal processing techniques incorporated in the Model 3582A provide direct measurement of phase spectra.

Simple modulated waveforms can illustrate the power of this capability. It is virtually impossible to determine from an amplitude display whether the modulation is amplitude modulation (AM) or low modulation index frequency modulation (FM). As shown, the phase spectrum clearly provides the additional information about the relative sideband phases that is necessary to make the distinction.

Resolve Low Level Components In The Presence Of Large Signals

In many applications such as amplifier testing, vibration analysis or underwater acoustics, the information of interest is contained not in the high amplitude fundamental, but rather in the low amplitude components. For a spectrum analyzer to provide useful information about these low level components in the presence of a large signal, it must offer wide dynamic range. The Model 3582A dynamic range is specified as 70 dB and typically the useable performance can be as much as 75 dB. The display shown illustrates the unwanted 60 Hz powerline sidebands on the output of a signal source

70 dB
dynamic
range
→

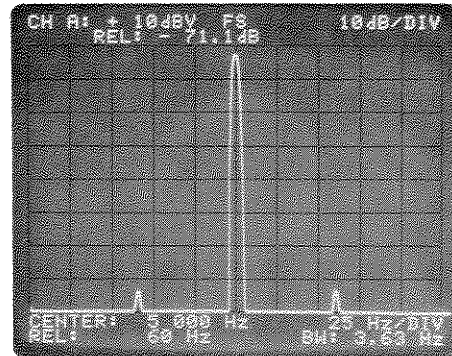

Investigate Cause/Effect Relationships With The Coherence Function



suspected cause

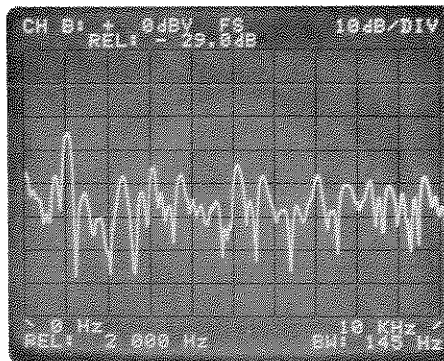

observed effect

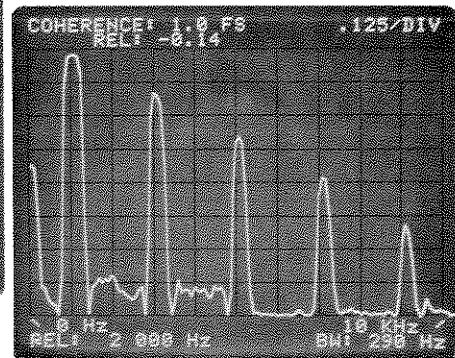

measured relationship

The measurement of a device transfer function assumes that the device under test is linear and that no portion of the output is caused by noise or extraneous signal sources. In active electronic circuits or mechanical structures these conditions can easily be violated—yet such violations are very difficult to identify. The Model 3582A considerably simplifies this problem by providing the direct measurement of the coherence function. This is a frequency domain measure of the fraction of the power in one signal (e.g., the output) caused by the other measured signal (e.g., the input). If this fraction is 1.0, the output at that frequency is caused by the input and the transfer function is valid. If the fraction is near 0.0, the output is caused by something other than the measured input. This cause could be noise, non-linearities or an unanticipated input, but the result is the same—the transfer function data at that frequency is suspect.

Where the coherence value is between 1.0 and 0.0, it provides a quantitative measure of the interfering signal or of the signal-to-noise ratio.

In addition to serving as a valuable check on the validity of transfer functions, the coherence function can be useful when investigating cause/effect relationships particularly in multiple input systems. It gives a measure of how much output power (either desirable or undesirable) at some frequency should be attributed to each input source without modifying operation of the system under test. For the two signals shown, the coherence measurement graphically illustrates the frequencies with a strong cause/effect relationship.

Application Note 245-2, titled "Measuring the Coherence Function with the HP 3582A Spectrum Analyzer," discusses the theory and practice of this measurement in more detail.

CRT Provides Calibrated Answers Directly

complete alphanumeric annotation

One of the most important features of the Model 3582A is its ease of use. Operator interaction with the instrument is simplified by the combination of intelligent microcomputer control and the alphanumeric display capability. The basic annotation clearly shows the major measurement parameters.

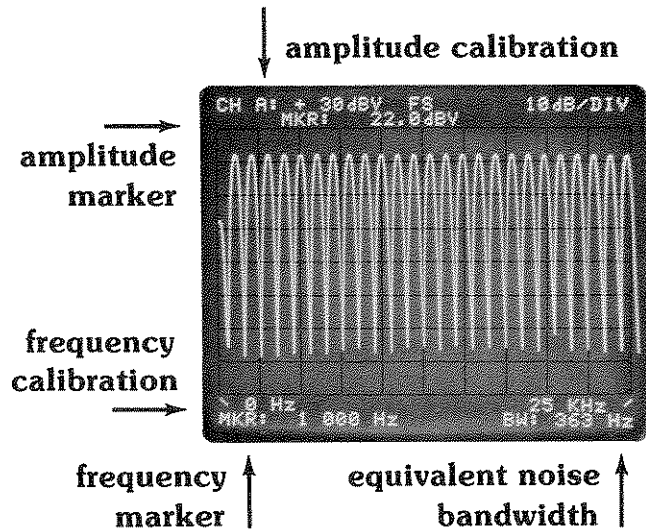

operational diagnostics

In addition to measurement results, the display is used to provide the operator with useful diagnostics. As the examples show, these tend to not only indicate the problem, but also to suggest an appropriate action.

marker aided measurements

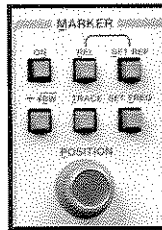

The intensified dot marker is a major operational convenience. When active the frequency and corresponding amplitude, phase or coherence value of the dot are displayed alphanumerically on the display. Since the results are calibrated, there is no need to go through the time-consuming, error-prone process of visually interpreting display points.

For operations such as determining frequency separation, the marker can read out in units relative to a previous marker setting which was defined as a reference point.

When making band analysis measurements, the marker can be used in place of the frequency adjust control to define a new start or center analysis frequency.

If two traces are active rather than one, the marker can be moved from trace to trace at will.

For noise measurements the marker results can be automatically normalized to a 1 Hz bandwidth to give noise density values.

digital trace storage

Two independent information traces can be stored in digital memory for later recall and comparison. Since the calibration data is not stored with the traces, the marker functions do not operate on stored traces.

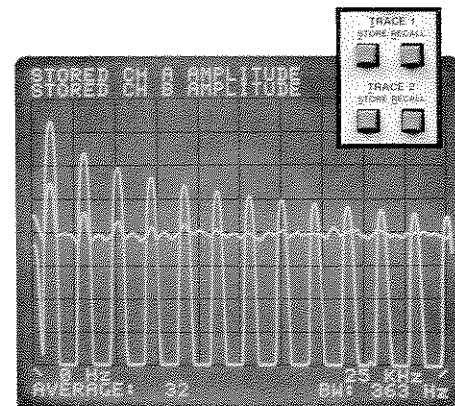

Automated Measurement Capability Via The HP-IB

ease of programming

The Hewlett-Packard Interface Bus* (HP-IB) is an interface concept that allows two way communication among as many as fifteen different devices. Generally, at least one of these devices is a "computing controller" which exercises overall system control. This controller directs and coordinates the activities of the other devices in the system. The rapidly growing number and variety of instruments featuring direct HP-IB programmability makes it possible to easily configure powerful measurement systems tailored to a specific set of requirements.

All major front panel controls with the exception of the verniers are fully programmable via the HP-IB. The programming codes are simple and are logically derived

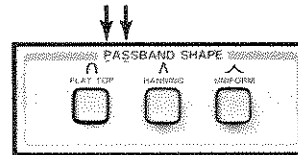

```
0: "FLAT TOP":  
1: wrt 711, "PS1"  
2: "HANNING":  
3: wrt 711, "PS2"  
4: "UNIFORM":  
5: wrt 711, "PS3"
```

from the front panel control labels. The states of the various controls occupy only ten 8-bit bytes of data that can be read and written by the HP-IB. This allows you to manually set up a test from the front panel and store it in a compact form. A pull-out card on the instrument details the various HP-IB programming conventions.

flexible data output capability

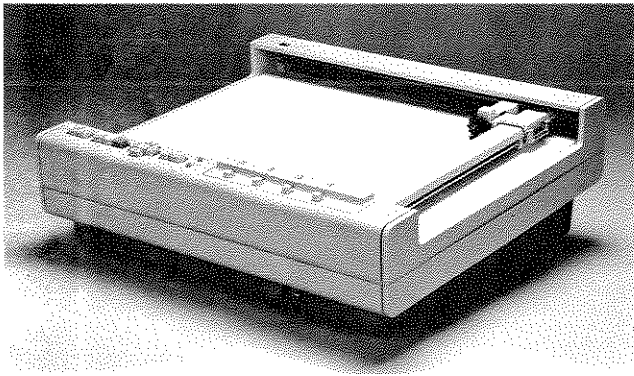

From the HP-IB it is a simple matter to command the Model 3582A to output results in a usable form. Not only can the various control settings be retrieved, but numeric marker data can be extracted. More importantly, the full display can be read in ASCII format along with complete annotation. This considerably simplifies the problems of data collection and storage.

If a multi-color plotter such as the HP Model 9872A Graphics Plotter is used with a computing controller, it is a simple matter to produce readable plots. When measuring transfer functions, it is possible to show amplitude, phase and coherence on one plot using different colors for the different traces and annotation.

flexible data input capability

The flexible HP-IB structure also allows a computing controller to input data other than commands to the Model 3582A. For example, a perfect time record can be synthesized from a mathematical model and input to the instrument for analysis. More importantly, stored display information such as the vibration signatures of a rotating machine can be input to the instrument for review. For example, weekly data could be reviewed sequentially. Also, the controller can mathematically process the stored data and format the results for display on the CRT. Since the controller can also write its own four lines of alphanumeric text, the results can be properly annotated and calibrated. The operator can even be given brief interpretation instructions—all on the CRT of the instrument.

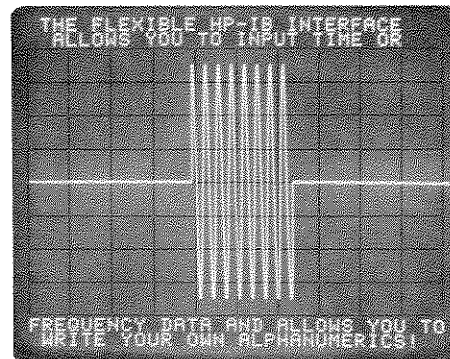

*The HP-IB is Hewlett-Packard's implementation of IEEE Standard 488 and ANSI Standard MC1.1. The present HP-IB definition is in concert with the corresponding IEC draft interface document approved by member nations of the Technical Committee 66 during 1976.

APPLICATIONS

Low Frequency Electronics

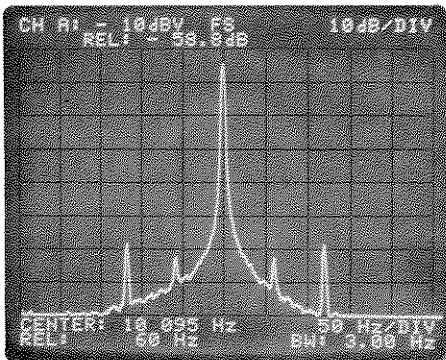

signal source

Spectrum analyzers have typically been of major value in characterizing the harmonic distortion, spurious outputs, level and frequency of signal sources. The Model 3582A not only makes these measurements better and more accurately than before, but it also makes them faster. The additional combination of "real-time" measurement speed and the powerful HP-IB capability make automated testing of these parameters very attractive.

In addition to characterizing low frequency sources, the Model 3582A can help characterize the short term random frequency fluctuations of a precision high frequency source. This is accomplished by mixing the high frequency signal down to DC and measuring the phase noise close-in to the carrier.

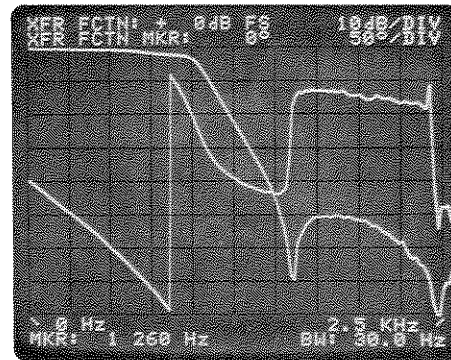

filter analysis

With direct transfer function measurements and the built-in driving source, the Model 3582A is well suited to performing a network analysis of low frequency devices such as filters. The example shows a five section low pass elliptic filter.

The ability to store and recall a display trace for comparison combined with rapid measurement speed makes the Model 3582A well suited to production type tuning and adjustment procedures. When a computing controller is added, a number of parameters such as shape factor or group delay can be derived from the basic data. These secondary results can be plotted or even displayed and annotated on the CRT display.

Telecommunications

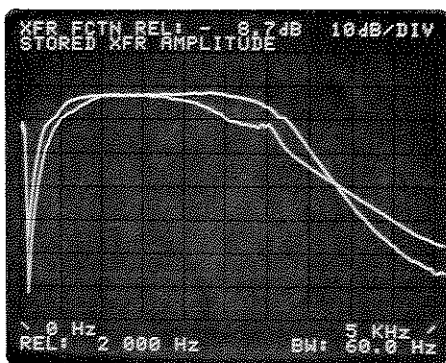

line conditioning

The frequency range and performance characteristics of the Model 3582A are well matched to the R&D and production needs of telecommunications. Voice frequency components including analog lines can be easily characterized. This example illustrates the amplitude dif-

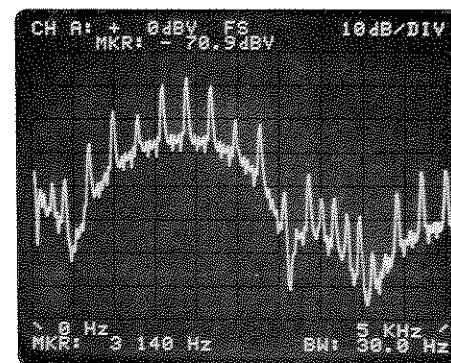

modem

ferences between two types of analog line conditioning.

Specialized signal sources such as multifrequency tone sources and modems can pose unusual testing problems. The example shows the frequency spectrum of a modem transmitting a string of asterisks.

Audio And Acoustics

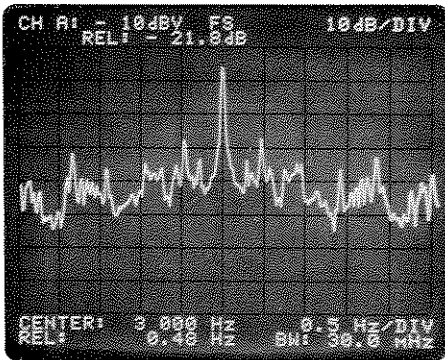

tape recorder

The Model 3582A has a number of features that make it well suited to the analysis of entertainment products. For example, an audio tape recorder is a moderately complex electromechanical system. Any unwanted mechanical speed variations will show up as discrete modulation sidebands on a recorded tone as shown.

With the frequency resolution of the Model 3582A, it is possible to identify the sidebands precisely enough to relate them to actual geometries.

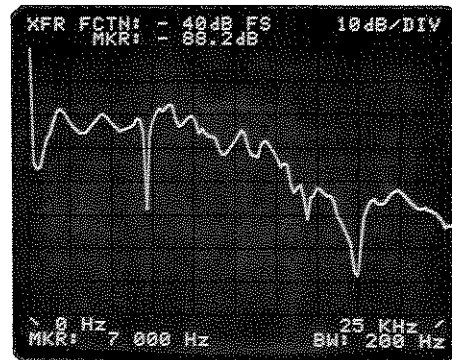

loudspeaker

Loudspeakers provide another interesting application example. By combining the built-in noise source with time averaging, it is possible to obtain valid characterizations even in the presence of ambient noise.

It is also possible to use impulse type signals for this measurement. Since the time record collection time is only a few milliseconds, this can minimize the echo problems.

With a slightly different hook-up the electrical impedance of a loudspeaker can even be measured.

Structural Analysis

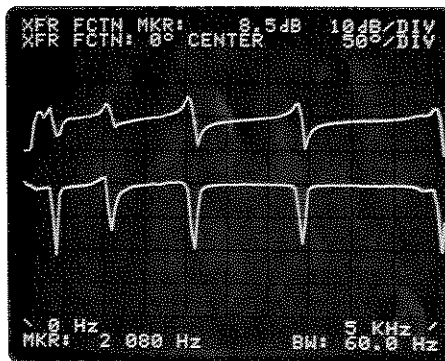

A broad range of mechanical structures can be adequately described as linear systems and can be characterized by these frequency domain transfer functions. These transfer functions relate applied forces and the resulting motion. This example illustrates the driving point inertance (acceleration/force) transfer function of a small beam.

Note that even for this very simple structure, there are several well defined sharp resonances which correspond to natural modes of vibration of the structure. The fastest method of identifying these characteristics is to measure and analyze a series of structural transfer functions.

Rotating Machinery Signatures

Every rotating machine exhibits a unique characteristic vibration pattern determined not only by the basic design and construction of the machine, but also by environmental factors and wear. With the appropriate transducers the Model 3582A can measure and analyze these vibration patterns or "signatures." As the following example shows, a signature is generally composed of a number of discrete spectral lines which can be related to mechanical geometries.

Processing a time related sequence of signatures can highlight impending wear problems before damage actually occurs. It can even provide indications of when maintenance operations should be scheduled.

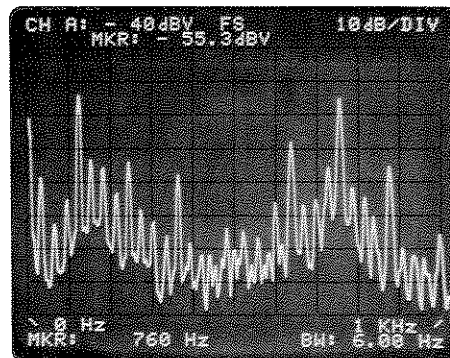

FREQUENCY

FREQUENCY MODES:

0-25 kHz Span: The selected measurement is performed over the fixed frequency range of 0 Hz to 25 kHz independent of the FREQUENCY SPAN control.

0-Start: The selected measurement is performed over the frequency range defined by the FREQUENCY SPAN control and with a fixed start frequency of 0 Hz.

Set Center: The selected measurement is performed over a frequency range with a width determined by the FREQUENCY SPAN control and with a center frequency variable with 1 Hz resolution.

Set Start: The selected measurement is performed over a frequency range with a width determined by the FREQUENCY SPAN control and with a start frequency variable with 1 Hz resolution.

FREQUENCY RANGE: 0.02 Hz to 25.5 kHz. The low frequency limit is the result of the DC response.

FREQUENCY SPANS:

0 Start Mode: 1 Hz full scale to 25 kHz full scale in a 1-2.5-5-10 sequence.

Set Start or Set Center mode: 5 Hz span to 25 kHz span in a 1-2.5-5-10 sequence.

FREQUENCY ACCURACY: The frequency accuracy is $\pm 0.003\%$ of the display center frequency.

FREQUENCY RESOLUTION: The marker resolution is equal to the calculated point spacing for the selected frequency span and number of channels (see Table I).

FILTER PASSBAND SHAPE:

	Flat Top	Hanning	Uniform
3 dB Bandwidth: (single-channel)	$(1.4 \pm 0.1)\%$ of span	$(0.58 \pm 0.05)\%$ of span	$(0.35 \pm 0.02)\%$ of span
Shape Factor: [60 dB bandwidth] [3 dB bandwidth]	$2.6 \pm .1$	$9.1 \pm .2$	716 ± 20

The FLAT PASSBAND SHAPE provides optimum amplitude accuracy. The UNIFORM PASSBAND SHAPE is optimized for use with transients and for use with the PERIODIC NOISE SOURCE, and the HANNING PASSBAND SHAPE provides an amplitude/frequency resolution compromise and is used for general noise measurements.

SINGLE-CHANNEL ANALYSIS PARAMETERS:

Frequency Span	Time Record Length (NΔt)	Calculated Point Spacing (Δf)	Equivalent Noise Bandwidth		
			Flat Top	Hanning	Uniform
1 Hz	250 sec.	.004 Hz	14.5 mHz	6.00 mHz	4.00 mHz
2.5 Hz	100 sec.	.01 Hz	36.3 mHz	15.0 mHz	10.0 mHz
5 Hz	50 sec.	.02 Hz	72.6 mHz	30.0 mHz	20.0 mHz
10 Hz	25 sec.	.04 Hz	145 mHz	60.0 mHz	40.0 mHz
25 Hz	10 sec.	.1 Hz	363 mHz	150 mHz	100 mHz
50 Hz	5 sec.	.2 Hz	726 mHz	300 mHz	200 mHz
100 Hz	2.5 sec.	.4 Hz	1.45 Hz	600 mHz	400 mHz
250 Hz	1 sec.	1 Hz	3.63 Hz	1.5 Hz	1.00 Hz
500 Hz	500 msec.	2 Hz	7.26 Hz	3.00 Hz	2.00 Hz
1 kHz	250 msec.	4 Hz	14.5 Hz	6.00 Hz	4.00 Hz
2.5 kHz	100 msec.	10 Hz	36.3 Hz	15.0 Hz	10.0 Hz
5 kHz	50 msec.	20 Hz	72.6 Hz	30.0 Hz	20.0 Hz
10 kHz	25 msec.	40 Hz	145 Hz	60.0 Hz	40.0 Hz
25 kHz	10 msec.	100 Hz	363 Hz	150 Hz	100 Hz

TABLE I

The corresponding dual channel parameters are found by doubling the calculated point spacing and equivalent noise bandwidth and taking one half the time record length.

AMPLITUDE

AMPLITUDE MEASUREMENT MODES: 256 point amplitude spectra are measured in the single-channel mode. Two 128 point amplitude spectra are measured in the dual-channel mode.

AMPLITUDE DISPLAY MODES:

Log: 10 dB/major division
2 dB/major division

Linear: Constant voltage/major division

AMPLITUDE MEASUREMENT RANGE:

Log: The calibrated attenuator range is +30 dBV to -50 dBV single tone RMS maximum input level in 10 dB ± 0.2 dB steps. The continuous vernier provides > 10 dB of additional uncalibrated sensitivity between the 10 dB steps.

Linear: The calibrated attenuator range is +30 volts RMS to 3 millivolts single tone RMS maximum input in a 1-3-10 sequence. The vernier provides continuous coverage between the major steps. The AMPLITUDE REFERENCE LEVEL provides 8 additional ranges down to 8 microvolts full scale.

DYNAMIC RANGE:

Distortion Products: > 70 dB below the maximum input level.

Spurious Responses: > 70 dB below the maximum input level.

Noise:

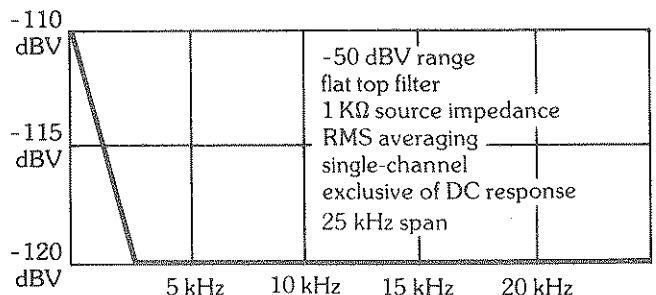

DC Response: Adjustable to > 40 dB below the maximum input level with the front panel DC balance adjustment.

AMPLITUDE (CONT.)

AMPLITUDE ACCURACY:

	Log
Accuracy at the Passband Center:	± 0.5 dB
Flat Top Filter:	+ 0, -0.1 dB
Hanning Filter:	+ 0, -1.5 dB
Uniform Filter:	+ 0, -4.0 dB

Overall accuracy is the sum of the accuracy at the passband center and the filter accuracy.

AMPLITUDE RESOLUTION:

Log: 0.1 dB with the marker

Linear: 3 digits with the marker

AMPLITUDE LINEARITY:

± 0.2 dB ± 0.02% of full scale

AMPLITUDE CALIBRATOR: The internal calibration signal is a line spectrum with nominal 1 kHz frequency spacing and a fundamental level of 22 ± 0.2 dBV on the log scales and 20 ± 0.5 volts on the linear scale.

AMPLITUDE OVERLOAD LIMITS:

Log: Overload occurs at 100% of the maximum input level which is equal to full scale when the AMPLITUDE REFERENCE LEVEL is set to NORMAL. When overload occurs spurious products may be displayed.

Linear: Overload occurs at 100% of the maximum input level which, depending on the input attenuator setting, is at 6/8 or 5/8 of full scale when the AMPLITUDE REFERENCE LEVEL is set to NORMAL. When overload occurs spurious products may be displayed.

PHASE

PHASE MEASUREMENT MODES: 256 point phase spectra are measured in the single-channel mode. Two 128 point phase spectra are measured in the dual channel mode.

PHASE DISPLAY RANGE: From 200 degrees to -200 degrees

PHASE ACCURACY: ± 10 degrees

PHASE RESOLUTION:

Display: 50 degrees/major division

Marker: 1 degree

TRANSFER FUNCTION

TRANSFER FUNCTION MEASUREMENT MODES: Dual-channel 128 point transfer functions are measured.

TRANSFER FUNCTION DISPLAY MODES:

Log Amplitude: 10 dB/major division
2 dB/major division

Linear Amplitude: Constant floating point fraction/major division

Phase: Constant 50 degrees/major division

TRANSFER FUNCTION MEASUREMENT RANGE:

Log Amplitude: Calibrated ranges of +160 dB full scale to -80 dB full scale in 10 dB steps. The uncalibrated verniers provide continuous coverage between the 10 dB steps.

Linear Amplitude: Calibrated ranges of 4.0×10^8 full scale to 4.0×10^{-8} full scale in factor of 10 steps. The uncalibrated verniers provide continuous coverage between the factor of 10 steps.

Phase Display Range: +200 degrees to -200 degrees.

TRANSFER FUNCTION ACCURACY:

Amplitude: ± 0.8 dB

Phase: ± 5 degrees

TRANSFER FUNCTION RESOLUTION:

Log Amplitude: 0.1 dB with the marker

Linear Amplitude: 3 digit scientific notation with the marker

Phase: 1 degree with the marker

COHERENCE FUNCTION

COHERENCE FUNCTION MEASUREMENT MODE:

Dual-channel 128 point coherence functions are measured with RMS averaging only.

COHERENCE MEASUREMENT RANGE: The bottom display line is 0.0 and the top display line is 1.0.

COHERENCE FUNCTION RESOLUTION:

Display: 0.125/major division

Marker: 0.01

TRIGGER

TRIGGER MODES:

Free Run: A new measurement is initiated by the completion of the previous measurement.

External: A rear panel switch allows new measurements to be initiated by an external TTL pulse.

Input Signal: A new measurement is initiated when the input signal meets the specified trigger condition.

TRIGGER CONDITIONS:

Signal Conditions: Triggering can be selected to occur on a positive or negative going transition through the trigger level. The trigger level is adjusted between the time record overload limits by a continuous vernier.

Single/Multiple Triggers: Single-shot triggering is specified by taking the instrument out of the REPETITIVE mode. The ARM control sensitizes the instrument to take another measurement in the non-repetitive mode.

INPUT CHANNELS

INPUT IMPEDANCE: $10^6\Omega \pm 5\%$ shunted by <60 pf from input high to low for less than 75% relative humidity.

DC ISOLATION: Input low may be connected to chassis ground or floated up to 30 volts to reduce the effects of ground loops on the measurement.

INPUT COUPLING: The input circuit may be AC or DC coupled. The low frequency 3 dB roll off of the AC coupling is <1 Hz.

COMMON MODE REJECTION:

50 Hz: >60 dB

60 Hz: >58 dB

INPUT CHANNEL CROSSTALK: <-140 dB between channels with 1 k Ω source impedance driving one channel and the other channel terminated in 1 k Ω .

OUTPUT SIGNALS

X-Y RECORDER:

Vertical: 0 to 5.25V $\pm 5\%$

Horizontal: 0 to 5.25V $\pm 5\%$

Impedance: 1 k Ω

Pen Lift: Contact closure during sweep.

NOISE SOURCE:

Periodic: Pseudorandom noise signal with spectral line spacings that match the calculated point spacing for the selected frequency span. The noise spectrum is band limited and band translated to match the selected measurement.

Random: Random noise signal; the noise spectrum is band limited and band translated to match the selected measurement.

Level: Vernier control from <10 mV to >500 mV RMS into a load of $\geq 50\Omega$.

Periodic Noise Frequency Response: ± 1 dB with UNIFORM PASSBAND SHAPE and -10 dBV level.

Impedance: $<2\Omega$

IMPULSE SOURCE: A TTL low to high pulse with a period equal to the time record length.

DISPLAY

CRT:

Screen Size: 11.9 cm (4.7 in.) wide by 9.6 cm (3.8 in.) high

Graticule: 10 major divisions horizontal by 8 major divisions vertical with internal illumination for CRT photography.

Text: Maximum of four 32 character lines of alphanumeric text.

or absolute marker frequency, relative or absolute marker phase, relative or absolute marker coherence, RMS noise density at the marker, time record collection time.

DISPLAY ACCURACY: Display accuracy is 3% of total height or width for $25 \pm 15^\circ\text{C}$. Note that if numeric readings are taken visually from the displayed trace, this factor must be added to the basic accuracy specification.

ALPHANUMERIC ANNOTATION: Single or dual channel configuration, input or stored trace, frequency calibration, amplitude calibration, equivalent noise bandwidth, relative

TRACE STORAGE: A maximum of two independent traces may be digitally stored and recalled. Annotation information is not stored with the traces.

AVERAGE

AVERAGING MODES:

RMS: For each calculated frequency point the displayed amplitude is

$$\sqrt{\frac{1}{N} \sum A_i^2(f)} \text{ and the phase is } \frac{1}{N} \sum \phi_i(f)$$

Peak: For each calculated frequency point the displayed amplitude is MAX $A_i(f)$ and the phase is the corresponding value for the retained amplitude point.

Time: For each time record point the amplitude is

$$\frac{1}{N} \sum A_i(t)$$

The averaged time record is transformed to give the corresponding amplitude and phase.

NUMBER OF AVERAGES: 4 to 256 in a binary sequence plus exponential. Exponential in the RMS mode gives a running average with new spectral data weighted 1/4 and the previous result by 3/4. Exponential in the peak mode gives a continuous peak hold operation.

REMOTE OPERATION

PROGRAMMING: All analyzer front panel controls except the CRT controls, NOISE SOURCE LEVEL and TYPE, TRIGGER LEVEL, AMPLITUDE VERNIERS, and GROUND ISOLATION are remotely programmable via the HP-IB.

DATA INPUT: Time records, amplitude and phase spectra, coherence functions, transfer functions and alphanumeric text can be input to the analyzer via the HP-IB.

DATA OUTPUT: Time records, amplitude and phase spectra, coherence functions, transfer functions, alphanumeric text, marker values and control settings can be output via the HP-IB.

GENERAL

ENVIRONMENTAL:

Operating Temperature: 0°C to +55°C

Non-operating Temperature: -40°C to +75°C

Humidity: to 95% relative humidity at 40°C.

Operating Altitude: 4600 Meters (15,000 feet)

Non-operating Altitude: 6300 Meters (25,000 feet)

Shock: 30 G, 11 Msec half sine wave on each of six sides.

Vibration: 10 Hz to 55 Hz at 0.010 inch peak-to-peak excursion.

OPERATING POWER: Switch selection of 110V +5, -10% or 230V +5, -10% or 230V +5, -10% 48-66 Hz; less than 150 VA.

PHYSICAL PARAMETERS:

Size: 425.5 mm (16.75 inches) wide
552.5 mm (21.75 inches) deep
188 mm (7.4 inches) high

Net Weight: 24.5 kg (54 lbs.).

Shipping Weight: 29 kg (63 lbs.).

ACCESSORIES

Transit Case: HP Part Number 9211-2656

Scope Camera: Model 197A Option 006

Divider Probes: 10001A

HP-IB Cables:

10631A 1 meter (3.3 feet)

10631B 2 meters (6.6 feet)

10631C 4 meters (13.2 feet)

Test Leads:

11000A 112 cm (44 in.); dual banana on both ends

11001A 112 cm (44 in.); dual banana to BNC

Slide Rack Mount:

HP Part Number 1494-0017 For standard slide kit

HP Part Number 1494-0026 For tilt slide kit

ORDERING INFORMATION

Model Number and Name	Price
3582A Spectrum Analyzer	\$10,000
Option 907, Front Handle Kit	25
For stand alone orders use HP part number 5061-0090	
Option 908, Rack Flange Kit	20
For stand alone orders use HP part number 5061-0078	
Option 909, Rack & Handle Kit	35
For stand alone orders use HP part number 5061-0084	
Option 910, Extra Manual	55

Domestic USA prices only

For more information, call your local HP Sales Office or East (301) 948-6370 • Midwest (312) 255-9800 • South (404) 955-1500 • West (213) 970-7710. Or write: Hewlett-Packard, 1501 Page Mill Road, Palo Alto, California 94304. In Europe: P.O. Box 85, CH-1217 Meyrin 2, Geneva, Switzerland. In Japan: YHP, 1-59-1, Yoyogi, Shibuya-Ku, Tokyo, 151.

Printed in U.S.A.

DATA SUBJECT TO CHANGE

5952-8769D

TABLE OF CONTENTS

Section	Page	Section	Page
I. GENERAL INFORMATION	1-1	3-55. Amplitude Reference Level.....	3-10
1-1. Introduction.....	1-1	3-58. The Passband Shape Controls.....	3-11
1-5. Specifications.....	1-1	3-61. The Noise Source.....	3-13
1-7. Safety Considerations.....	1-1	3-65. Impulse Output.....	3-14
1-9. Instruction Manual Symbol.....	1-1	3-68. Dual Channel Measurements.....	3-15
1-11. Instruments Covered by Manual.....	1-1	3-94. Storing Traces.....	3-24
1-16. Description.....	1-2	3-97. Conclusion.....	3-25
1-27. Options.....	1-3	3-99. Operating on Signal Data.....	3-25
1-29. Accessories Supplied.....	1-3	3-100. Introduction.....	3-25
1-31. Accessories Available.....	1-4	3-102. Acquiring a Time Record.....	3-25
1-33. Recommended Test Equipment.....	1-4	3-104. Operating on Stored Time Data.....	3-25
 		3-106. Using the Recorder Output.....	3-26
Section	Page	3-109. Using Probes.....	3-26
II. INSTALLATION	2-1	3-111. Probes Are Delicate.....	3-27
2-1. Introduction.....	2-1	3-113. Probe Compensation Procedure.....	3-27
2-3. Initial Inspection.....	2-1	3-115. Front Panel Screwdriver	
2-5. Power Requirements.....	2-1	Adjustments.....	3-28
2-7. Line Voltage and Fuse Selection.....	2-1	3-117. ASTIG Adjustment.....	3-29
2-9. Power Cable and Grounding		3-119. BAL Adjustments.....	3-29
Requirements.....	2-2	3-122. In Case of Trouble.....	3-29
2-11. Operating Environment.....	2-2	3-123. Introduction.....	3-29
2-12. Temperature.....	2-2	3-125. "Hung UP".....	3-30
2-14. Humidity.....	2-2	3-127. Overload.....	3-30
2-16. Altitude.....	2-2	3-129. Unrelated Spectral Displays.....	3-31
2-18. Cooling Fan.....	2-2	3-131. Noise Source Output.....	3-31
2-20. Thermal Cutout.....	2-2	3-133. Simplification of Discrete Data	
2-22. Installation.....	2-3	Analysis.....	3-31
2-23. Mounting.....	2-3	3-134. Introduction.....	3-31
2-26. HP-IB System Interface Connections.....	2-3	3-136. Time Domain Considerations.....	3-32
2-30. Cable Length Restrictions.....	2-4	3-139. Frequency Domain Considerations.....	3-32
2-32. HP-IB Address Selection.....	2-5	3-147. Aliasing.....	3-34
2-34. Storage and Shipment.....	2-6	3-150. Data in Memory.....	3-35
2-35. Environment.....	2-6	3-153. Interpreting the Display.....	3-36
2-37. Packaging.....	2-6	3-156. Leakage.....	3-37
 		3-158. Windowing.....	3-37
Section	Page	3-163. Window Functions.....	3-38
III. MANUAL OPERATION	3-1	REMOTE OPERATION	3-39
3-1. Introduction.....	3-1	3-165. Remote Operation.....	3-39
3-3. Controls, Connectors, and Indicators.....	3-1	3-166. Introduction.....	3-39
3-5. Turn-On Procedure.....	3-1	3-169. 3582A Remote Functions.....	3-39
3-8. About Spectrum Analyzers.....	3-2	3-170. General Description.....	3-39
3-10. A Comparison.....	3-2	3-172. Remote Front Panel Programming.....	3-40
3-13. Features.....	3-2	3-176. Syntax.....	3-40
3-15. The Display.....	3-2	3-180. Delimiters.....	3-41
3-19. Familiarization Exercise.....	3-3	3-182. Special Front Panel Commands.....	3-41
3-20. Introduction.....	3-3	3-184. Using Preset.....	3-41
3-22. Adjusting the Display.....	3-4	3-186. Setting the Marker.....	3-41
3-24. The CAL Signal.....	3-4	3-189. Instrument Data Output.....	3-42
3-27. The Input Mode Switch.....	3-4	3-191. Listing Control Settings.....	3-42
3-29. Input Considerations.....	3-5	3-194. Program Examples.....	3-42
3-34. Analyzing an Input Signal.....	3-5	3-199. Program Example.....	3-45
3-46. The Frequency Span Controls.....	3-8	3-201. Program Example.....	3-46
3-53. Scales.....	3-9	3-202. Instrument Data Input.....	3-47

TABLE OF CONTENTS (Cont'd)

Section	Page	Section	Page
3-203. Writing Alphanumeric Messages	3-47	OPERATIONAL VERIFICATION	3-57
3-205. Program Example	3-48	3-236. Operational Verification	3-57
3-206. Working With Memory	3-48	3-238. Required Test Equipment	3-57
3-208. The Binary Format	3-48	3-240. Preset	3-57
3-212. Memory Instructions	3-49	3-242. Instrument Warmup	3-57
3-215. Memory Locations	3-49	3-245. DC BAL Verification	3-59
3-217. Instrument Signal Processing Control and Status	3-50	3-248. ROM Self Test	3-59
3-218. Service Request	3-50	3-252. Display Accuracy	3-59
3-220. Status Word	3-50	3-257. Calibrator Accuracy	3-60
3-223. Program Example	3-51	3-262. Amplitude Accuracy and Flatness	3-60
3-224. Processor Control Commands	3-51	3-267. Noise Level	3-61
3-226. Example Flowcharts and Programs	3-51	3-272. Harmonic Distortion	3-62
3-227. Loading a Time Record Into Memory	3-51	3-277. Common Mode Rejection	3-63
3-229. Program Example: Writing to Memory	3-53	3-282. Frequency Accuracy	3-64
3-230. Reading Binary Data From Memory	3-53	3-287. Phase Accuracy	3-65
3-232. The Learn Mode	3-53	3-292. Amplitude and Phase Match Between Channels	3-66
3-234. Program Example: The Learn Mode	3-55	3-297. Controls, Connectors and Indicators	3-67
3-235. Program Example: Plotting The Display	3-56	APPENDICES	
		A. HP-IB Command List	
		B. Condensed Description of the HP-IB	
		C. Condensed Description of Meta Messages	
		D. Application Notes	

LIST OF TABLES

Table	Page
1-1. Options	1-3
1-2. Accessories Supplied	1-3
1-3. Accessories Available	1-4
1-4. Recommended Test Equipment	1-5
1-5. Specifications	1-6
2-1. HP-IB Cables	2-5
2-2. Address Selection	2-5
3-1. Impulse Output Pulse Period	3-14
3-2. LDS Points Returned	3-45
3-3. Output Units	3-45
3-4. Display-ASCII Equivalents	3-46
3-5. Recommended Test Equipment for Operational Verification	3-58
3-6. Recommended Test Accessories	3-58
3-7. Amplitude Accuracy and Flatness	3-61

LIST OF ILLUSTRATIONS

Figure	Page	Figure	Page
2-1. Line Voltage and Fuse Selection	2-1	3-24. A Two Trace Plot	3-27
2-2. Power Cables	2-2	3-25. About Scope Probes	3-28
2-3. Typical HP-IB System Interconnection	2-3	3-26. Probe Compensation	3-28
2-4. HP-IB Connector	2-4	3-27. Adjusting the BAL Control	3-30
3-1. The Channel A CAL Signal	3-4	3-28. Sampling an Input Waveform	3-32
3-2. Spectrum of a 1 kHz Square Wave	3-6	3-29. Windowing a Sampled Waveform	3-32
3-3. Setting the Marker Position	3-7	3-30. Frequency Representation of a Cosine Wave	3-33
3-4. Using the SPAN Control to Resolve Sidebands	3-9	3-31. Frequency Representation of an Impulse Train	3-33
3-5. Expanding a Portion of the Display	3-11	3-32. Frequency Representation of a Square Pulse	3-33
3-6. Full Scale Reference in the LINEAR Mode	3-11	3-33. Convolution of the Cosine Spectrum with the Sampling Pulse Spectrum	3-34
3-7. A Sine Wave Spectrum Using the FLAT TOP Passband	3-12	3-34. Convolution of a Sampled Cosine Spectrum with a Window Spectrum	3-34
3-8. Sine Wave Spectrum Using the HANNING Passband	3-13	3-35. Increasing the Frequency of a Cosine Wave	3-34
3-9. Sine Wave Spectrum Using the UNIFORM Passband	3-13	3-36. Aliasing	3-35
3-10. Noise Source Spectrums	3-14	3-37. 3582A Antialiasing Filter	3-35
3-11. A Two Port Network	3-15	3-38. The Continuous Function	3-35
3-12. Connecting a Single Pole Low Pass Filter	3-15	3-39. Spectrum Points in Memory	3-36
3-13. Input and Output Spectrum of a Low Pass Filter	3-16	3-40. Memory Data Points Displayed on CRT	3-36
3-14. Transfer Function for a Two Port Network	3-17	3-41. Leakage of Energy	3-37
3-15. Phase Transfer Function of a Low Pass Filter	3-18	3-42. Sidelobes of Transformed Rectangular Window	3-37
3-16. Phase Spectrum of a Triangle Wave	3-19	3-43. Data Flow	3-38
3-17. Selecting the Correct Harmonic	3-21	3-44. Window Functions	3-38
3-18. Modulating a Spectral Line with Noise	3-21	3-45. Words in Memory	3-48
3-19. RMS Averaged Signals	3-21	3-46. Storing a Time Record in Memory	3-52
3-20. TIME Averaged Signals	3-22	3-47. Reading Binary Data From Memory	3-54
3-21. Oscillating Frequency Spectrum	3-22	3-48. 3582A Front Panel Controls, Connectors and Indicators	3-69/3-70
3-22. Spectrum of an FM Passband	3-23	3-49. 3582A Rear Panel Connectors, Switches and Filter	3-71/3-72
3-23. The Coherence Relationship Between Two Signals	3-23		

SAFETY SUMMARY

The following general safety precautions must be observed during all phases of operation, service, and repair of this instrument. Failure to comply with these precautions or with specific warnings elsewhere in this manual violates safety standards of design, manufacture, and intended use of the instrument. Hewlett-Packard Company assumes no liability for the customer's failure to comply with these requirements.

GROUND THE INSTRUMENT.

To minimize shock hazard, the instrument chassis and cabinet must be connected to an electrical ground. The instrument is equipped with a three-conductor ac power cable. The power cable must either be plugged into an approved three-contact electrical outlet or used with a three-contact to two-contact adapter with the grounding wire (green) firmly connected to an electrical ground (safety ground) at the power outlet. The power jack and mating plug of the power cable meet International Electrotechnical Commission (IEC) safety standards.

DO NOT OPERATE IN AN EXPLOSIVE ATMOSPHERE.

Do not operate the instrument in the presence of flammable gases or fumes. Operation of any electrical instrument in such an environment constitutes a definite safety hazard.

KEEP AWAY FROM LIVE CIRCUITS.

Operating personnel must not remove instrument covers. Component replacement and internal adjustments must be made by qualified maintenance personnel. Do not replace components with power cable connected. Under certain conditions, dangerous voltages may exist even with the power cable removed. To avoid injuries, always disconnect power and discharge circuits before touching them.

DO NOT SERVICE OR ADJUST ALONE.

Do not attempt internal service or adjustment unless another person, capable of rendering first aid and resuscitation, is present.

USE CAUTION WHEN EXPOSING OR HANDLING THE CRT.

Breakage of the Cathode-ray Tube (CRT) causes a high-velocity scattering of glass fragments (implosion). To prevent CRT implosion, avoid rough handling or jarring of the instrument. Handling of the CRT shall be done only by qualified maintenance personnel using approved safety mask and gloves.

DO NOT SUBSTITUTE PARTS OR MODIFY INSTRUMENT.

Because of the danger of introducing additional hazards, do not install substitute parts or perform any unauthorized modification to the instrument. Return the instrument to a Hewlett-Packard Sales and Service Office for service and repair to ensure that safety features are maintained.

DANGEROUS PROCEDURE WARNINGS.

Warnings, such as the example below, precede potentially dangerous procedures throughout this manual. Instructions contained in the warnings must be followed.

WARNING

**Dangerous voltages, capable of causing death, are present in this instrument.
Use extreme caution when handling, testing, and adjusting.**

General Definitions of Safety Symbols Used On Equipment



Instruction manual symbol: the product will be marked with this symbol when it is necessary for the user to refer to the instruction manual in order to protect against damage to the instrument.



Indicates dangerous voltage (terminals fed from the interior by voltage exceeding 1000 volts must be so marked).

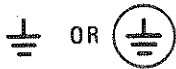

Protective conductor terminal. For protection against electrical shock in case of a fault. Used with field wiring terminals to indicate the terminal which must be connected to ground before operating equipment.



Low-noise or noiseless, clean ground (earth) terminal. Used for a signal common, as well as providing protection against electrical shock in case of a fault. A terminal marked with this symbol must be connected to ground in the manner described in the installation (operating) manual, and before operating the equipment.

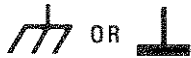

Frame or chassis terminal. A connection to the frame (chassis) of the equipment which normally includes all exposed metal structures.



Alternating current (power line).



Direct current (power line).



Alternating or direct current (power line).



The WARNING sign denotes a hazard. It calls attention to a procedure, practice, or the like, which, if not correctly performed or adhered to, could result in personal injury.



The CAUTION sign denotes a hazard. It calls attention to an operating procedure, practice, or the like, which if not correctly performed or adhered to, could result in damage to or destruction of part or all of the product.

SECTION I

GENERAL INFORMATION

1-1. INTRODUCTION.

1-2. The Operating Manual contains information required to install, operate, and verify the instrument's operational capabilities.

1-3. The Service Manual contains the necessary information to test, adjust, and service the 3582A Spectrum Analyzer.

1-4. The part number of this manual is listed on the title page. Also listed on the title page is a Microfiche part number. This number can be used to order 4×6 inch microfilm transparencies of the manual. Each microfiche contains photo-duplicates of up to 96 manual pages. The microfiche package also includes the latest Manual Changes supplement as well as pertinent Service Notes.

1-5. SPECIFICATIONS.

1-6. Instrument specifications are listed in Table 1-5. These specifications are the performance standards against which the instrument is tested.

1-7. SAFETY CONSIDERATIONS.

1-8. This product is a Safety Class 1 instrument (provided with a 3-wire cord). The instrument and manual should be reviewed for safety markings and instructions before operation.

1-9. INSTRUCTION MANUAL SYMBOL.

1-10. Wherever the 3582A instrument is marked with this symbol, the user should refer to the instruction manual in order to protect against damage to the instrument. This symbol is found primarily in the Service Manual.

1-11. INSTRUMENTS COVERED BY MANUAL.

1-12. Attached to the instrument is a serial number plate. The serial number is in the form: 0000A00000. It is in two parts; the first four digits and the letter are the serial prefix and the last five digits are the suffix. The prefix is the same for all identical instruments; it changes only when a change is made to the instrument. The suffix, however, is assigned sequentially and is different for each instrument. The contents of this manual apply to instruments with serial number prefix(es) listed under SERIAL NUMBERS on the title page.

1-13. An instrument manufactured after the printing of this manual may have a serial number prefix that is not listed on the title page. This unlisted serial number prefix indicates the instrument is different from those described in this manual. The manual for this newer instrument is accompanied by a yellow Manual Changes supplement. This supplement contains "change information" that explains how to adapt the manual to the newer instrument.

1-14. In addition to change information, the supplement may contain information for correcting errors in the manual. To keep this manual as current and accurate as possible, Hewlett-Packard recommends that you periodically request the latest Manual Changes supplement. The supplement for this manual is identified with the manual part number, which also appears on the manual title page. Complementary copies of the supplement are available from Hewlett-Packard.

1-15. For information concerning a serial number prefix that is not listed on the title page or in the Manual Changes supplement, contact your nearest Hewlett-Packard Sales and Service Office.

1-16. DESCRIPTION.

1-17. The -hp- Model 3582A is a dual-channel spectrum analyzer covering the frequency range of 0.02 Hz to 25.6 kHz. By combining advanced digital processing techniques and a powerful micro-computer, it can provide measurement capability previously found only in complicated computer systems.

1-18. The performance features of the instrument provide optimal solutions to the problems of low frequency spectrum analysis. Frequency spans from 1 Hz to 25 kHz full scale allow great flexibility in selecting the portion of the spectrum to be analyzed. The spans from 5 Hz up to 25 kHz can be positioned anywhere within the frequency range of the instrument to provide exceptionally good frequency resolution.

1-19. Without resorting to external signal conditioning, the instrument can measure input from +30 dBV (31.6 volts) down to -120 dBV (1 microvolt). Even with this high sensitivity, the input circuits are protected against overloads of up to 100 volts. For measurements where the signal of interest exists in the presence of large unwanted signals, the wide 70 dB dynamic range of the instrument is important.

1-20. These spectrum measurements are made with "real-time" speed for frequency spans less than 500 Hz. Here real-time means that processing time is less than data acquisition time so that no input data is "lost" while waiting for processing. Data acquisition time must be increased for narrower spans to provide the required resolution. For broader spans, data acquisition time is small and processing speed becomes the limiting factor.

1-21. The Model 3582A can also measure the phase of the various spectral components or transfer function. This makes it possible to fully characterize a signal and can provide new insight into the operation of complex electrical or mechanical devices.

1-22. The most significant additional measurement capabilities of the instrument result from having two input channels that operate simultaneously. Not only can independent input signals be examined for common characteristics, but also device input/output relationships can be evaluated. The instrument directly provides both amplitude and phase information of the transfer function of a device. A built-in pseudo-random noise or a built-in random "band limited white noise" source can be used to drive the device under test to perform low frequency network analysis.

NOTE

The random "band limited white noise" source is not available on instruments with serial numbers prefixed 1747A.

1-23. Many signals cannot be analyzed with conventional spectrum analyzers because they are not stable. Digital signal processing techniques allow the Model 3582A to capture and analyze transient signals that last for only a few milliseconds.

1-24. In the Model 3582A, the large-screen CRT makes the measurement results available in a highly usable form. In addition to two simultaneous information traces, the display provides four lines of alphanumeric data giving measurement configuration and results. The alphanumeric marker makes it possible to read results directly in absolute or relative units. In addition to measurement results, the CRT is also used to display operational diagnostic messages.

1-25. In order to provide maximum confidence in the operation of the instrument, self test routines have been built in. These tests, in conjunction with the internal calibration signal, make it possible to quickly verify the calibration of the instrument before beginning a critical measurement sequence.

1-26. Virtually all of the measurement functions of the Model 3582A are remotely programmable via the Hewlett-Packard Interface Bus (HP-IB). Since actual measurement data can be remotely input or output, it is possible with a computing controller to extend the basic measurement capability.

1-27. OPTIONS.

1-28. Table 1-1 lists the options which are available for the 3582A. These options may be ordered with the instrument or installed later.

Table 1-1. Options.

3582A Option	-hp- Part Number	Description
907	5061-0090	Front Handle Kit
908	5061-0078	Rack Flange Kit
909	6061-0084	Rack Flange and Handle Kit
910	03582-90000	Extra Operating Manual
910	03582-90001	Extra Service Manual

1-29. ACCESSORIES SUPPLIED.

1-30. Table 1-2 lists the accessories supplied with the -hp- Model 3582A Spectrum Analyzer.

Table 1-2. Accessories Supplied.

Item	Quantity	-hp- Part Number
Accessory Kit (includes the following):	1 ea.	03582-84401
PC Board Extender	1 ea.	03582-66531
PC Board Extender	1 ea.	03582-66532
PC Board Extender	1 ea.	03582-66533
Fuse 1 amp 250 V Fast Blo	1 ea.	2110-0001
Fuse .25 amp 250 V Slow Blo	1 ea.	2110-0201
Fuse 1.5 amp 250 V Normal Blo	1 ea.	2110-0043
For use in the Familiarization Exercise:		
Capacitor, 3000 pF 5% 300 V	1 ea.	0160-2229
Resistor, 10 k Ω 1% ¼ W	1 ea.	0757-0442

1-31. ACCESSORIES AVAILABLE.

1-32. Table 1-3 indicates the accessories which are available for the -hp- 3582A. These accessories may be obtained through your -hp- Sales and Service Office.

Table 1-3. Accessories Available.

Accessory	-hp- Model
10:1 Voltage Divider Probe	10001A
HP-IB Cables	10631A 1 meter (3.3 feet)
	10631B 2 meters (6.6 feet)
	10631C 4 meters (13.2 feet)
	Model 197A Option 006
Scope Camera	Standard Slide Kit (-hp- Part No. 1497-0017)
Slide Rack Mount	Tilt Slide Kit (-hp- Part No. 1494-0020)
Test Leads	11000A 112 cm (44 in);dual banana both ends
	11001A 112 cm (44 in);dual banana to BNC

1-33. RECOMMENDED TEST EQUIPMENT.

1-34. Equipment required to maintain the Model 3582A is listed in Table 1-4. Other equipment may be substituted if it meets or exceeds the critical specifications listed in the table.

1-35. Note that the Performance Test is automatic and controlled via the Hewlett-Packard Interface Bus (HP-IB). Thus, the calculator and HP-IB compatibility for the instruments is not strictly required. However, the full manual test will take about 10 times longer than the automatic test.

1-36. If manual testing must be done, it is recommended that only the Performance Test appropriate to a specific problem and/or repair be done, supplemented by the Operational Verification given at the end of Section III.

Table 1-4. Recommended Test Equipment.

Instrument	Required Characteristics	Recommended Model	Use*
Audio Oscillator	Harmonics, Hum and Noise Down at least 86 dB Freq. Range: 10 Hz – 25 kHz Output Level: 10 dBV (3.16 Vrms)	-hp- 239A/339A (See Note 1)	P
Bus Analyzer	Bus System Analyzer Meeting I.E.E.E. 488-1975 Standards	-hp- 59401A	T
Calculator (Controller)	(See Note 2)	-hp- 9825A	P
HP-IB Interface	(See Note 2)	-hp- 98034A	P
Calculator ROM's	(See Note 2)	-hp- 98210A -hp- 98211A -hp- 98214A	P
Counter	6 Digits Frequency Range: 200 HZ – 200 kHz Sensitivity: 50 mV rms Input Impedance: 1 M Ω , < 50 pF	-hp- 5328A -hp- 5328A	T T
Digital Voltmeter	HP-IB Capability AC Function: Frequency Range: 200 HZ – 100 kHz Accuracy: \pm (0.1% of RDNG + 0.025% of range) DC Function: Accuracy: \pm (0.005% of RDNG + 0.001% of range)	-hp- 3455A	P, T
High Voltage Probe	1000:1 Division 1% Accuracy at 4 kV	-hp- 3440A-K05	A, T
Logic Probe	TTL Compatible	-hp- 10525A	T
Logic State Analyzer	TTL Compatible	-hp- 1602A	T
Oscilloscope	50 MHz; range down to 5 mV/Div	-hp- 1740A -hp- 10007A Probe	T
Synthesizer:	HP-IB Capability Frequency Range: 0.001 Hz–200 kHz Amplitude Range: – 80 dBm to + 13 dBm (50 ohms) Amplitude Accuracy: \pm 0.2 dB at 10 kHz and -70 dBm	-hp- 3330B (See Note 3)	P, T, A
50 Ω Termination	50 \pm 0.1 ohm; Feedthru	-hp- 11048C	P, T, A,
Function Generator:	Square and Triangle Outputs	-hp- 3311A	P
Load Resistors	1.3 ohms, 5%, 40 watt 0.75 ohms, 5%, 40 watt		

NOTE 1: The 339A is a distortion measurement set with built-in low distortion oscillator. The oscillator alone is available as the 239A. Check with your nearest -hp- Sales Office for further information.

NOTE 2: Performance test software is written for the -hp- 9825A Calculator and 9871A Printer. Use of a different printer will require program modification. The test can be run using the 9825A's Printer, but the printout will be pass/fail rather than the full explanation given with the 9871A.

NOTE 3: For manual testing, a 3320B can be used at substantially lower cost.

*P = Performance Test; A = Adjustments; T = Troubleshooting

Table 1-5. Specifications.

FREQUENCY

FREQUENCY MODES:

0-25 kHz Span: The selected measurement is performed over the fixed frequency range of 0 Hz to 25 kHz independent of the FREQUENCY SPAN control.

0-Start: The selected measurement is performed over the frequency range defined by the FREQUENCY SPAN control and with a fixed start frequency of 0 Hz.

Set Center: The selected measurement is performed over a frequency range with a width determined by the FREQUENCY SPAN control and with a center frequency variable with 1 Hz resolution.

Set Start: The selected measurement is performed over a frequency range with a width determined by the FREQUENCY SPAN control and with a start frequency variable with 1 Hz resolution.

FREQUENCY RANGE: 0.02 Hz to 25.5 kHz. The low frequency limit is the result of the DC response.

FREQUENCY SPANS:

0 Start Mode: 1 Hz full scale to 25 kHz full scale in a 1-2.5-5-10 sequence.

Set Start or Set Center mode: 5 Hz span to 25 kHz span in a 1-2.5-5-10 sequence.

FREQUENCY ACCURACY: The frequency accuracy is $\pm 0.003\%$ of the display center frequency.

FREQUENCY RESOLUTION: The marker resolution is equal to the calculated point spacing for the selected frequency span and number of channels (see Table I).

FILTER PASSBAND SHAPE:

	Flat Top	Hanning	Uniform
3 dB Bandwidth: (single-channel) of span	$1.4 \pm 0.1\%$	$(0.58 \pm 0.05)\%$ of span	$(0.35 \pm 0.02)\%$ of span
Shape Factor: $\frac{60 \text{ dB bandwidth}}{3 \text{ dB bandwidth}}$	$2.6 \pm .1$	$9.1 \pm .2$	716 ± 20

The FLAT PASSBAND SHAPE provides optimum amplitude accuracy. The UNIFORM PASSBAND SHAPE is optimized for use with transients and for use with the PERIODIC NOISE SOURCE, and the HANNING PASSBAND SHAPE provides an amplitude/frequency resolution compromise and is used for general noise measurements.

SINGLE-CHANNEL ANALYSIS PARAMETERS:

Frequency Span	Time Record Length (NΔt)	Calculated Point Spacing (Δf)	Equivalent Noise Bandwidth		
			Flat Top	Hanning	Uniform
1 Hz	250 sec.	.004 Hz	14.5 mHz	6.00 mHz	4.00 mHz
2.5 Hz	100 sec.	.01 Hz	36.3 mHz	15.0 mHz	10.0 mHz
5 Hz	50 sec.	.02 Hz	72.6 mHz	30.0 mHz	20.0 mHz
10 Hz	25 sec.	.04 Hz	145 mHz	60.0 mHz	40.0 mHz
25 Hz	10 sec.	.1 Hz	363 mHz	150 mHz	100 mHz
50 Hz	5 sec.	.2 Hz	726 mHz	300 mHz	200 mHz
100 Hz	2.5 sec.	.4 Hz	1.45 Hz	600 mHz	400 mHz
250 Hz	1 sec.	1 Hz	3.63 Hz	1.5 Hz	1.00 Hz
500 Hz	500 msec.	2 Hz	7.26 Hz	3.00 Hz	2.00 Hz
1 kHz	250 msec.	4 Hz	14.5 Hz	6.00 Hz	4.00 Hz
2.5 kHz	100 msec.	10 Hz	36.3 Hz	15.0 Hz	10.0 Hz
5 kHz	50 msec.	20 Hz	72.6 Hz	30.0 Hz	20.0 Hz
10 kHz	25 msec.	40 Hz	145 Hz	60.0 Hz	40.0 Hz
25 kHz	10 msec.	100 Hz	363 Hz	150 Hz	100 Hz

TABLE I

The corresponding dual channel parameters are found by doubling the calculated point spacing and equivalent noise bandwidth and taking one half the time record length.

AMPLITUDE

AMPLITUDE MEASUREMENT MODES: 256 point amplitude spectra are measured in the single-channel mode. Two 128 point amplitude spectra are measured in the dual-channel mode.

AMPLITUDE DISPLAY MODES:

Log: 10 dB/major division
2 dB/major division

Linear: Constant voltage/major division

AMPLITUDE MEASUREMENT RANGE:

Log: The calibrated attenuator range is +30 dBV to -50 dBV single tone RMS maximum input level in 10 dB ± 0.2 dB steps. The continuous vernier provides > 10 dB of additional uncalibrated sensitivity between the 10 dB steps.

Linear: The calibrated attenuator range is +30 volts RMS to 3 millivolts single tone RMS maximum input in a 1-3-10 sequence. The vernier provides continuous coverage between the major steps. The AMPLITUDE REFERENCE LEVEL provides 8 additional ranges down to 8 microvolts full scale.

DYNAMIC RANGE:

Distortion Products: > 70 dB below the maximum input level.

Spurious Responses: > 70 dB below the maximum input level.

Noise:

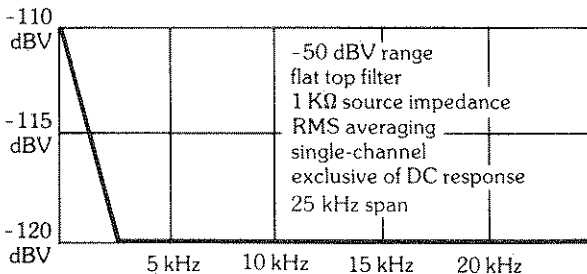

DC Response: Adjustable to > 40 dB below the maximum input level with the front panel DC balance adjustment.

Table 1-5. Specifications (Cont'd).

AMPLITUDE (CONT.)

AMPLITUDE ACCURACY:

	Log
Accuracy at the Passband Center:	± 0.5 dB
Flat Top Filter:	+0, -0.1 dB
Hanning Filter:	+0, -1.5 dB
Uniform Filter:	+0, -4.0 dB

Overall accuracy is the sum of the accuracy at the passband center and the filter accuracy.

AMPLITUDE RESOLUTION:

Log: 0.1 dB with the marker

Linear: 3 digits with the marker

AMPLITUDE LINEARITY:

± 0.2 dB $\pm 0.02\%$ of full scale

AMPLITUDE CALIBRATOR: The internal calibration signal is a line spectrum with nominal 1 kHz frequency spacing and a fundamental level of 22 ± 0.2 dBV on the log scales and 20 ± 0.5 volts on the linear scale.

AMPLITUDE OVERLOAD LIMITS:

Log: Overload occurs at 100% of the maximum input level which is equal to full scale when the AMPLITUDE REFERENCE LEVEL is set to NORMAL. When overload occurs spurious products may be displayed.

Linear: Overload occurs at 100% of the maximum input level which, depending on the input attenuator setting, is at 6/8 or 5/8 of full scale when the AMPLITUDE REFERENCE LEVEL is set to NORMAL. When overload occurs spurious products may be displayed.

PHASE

PHASE MEASUREMENT MODES: 256 point phase spectra are measured in the single-channel mode. Two 128 point phase spectra are measured in the dual channel mode.

PHASE DISPLAY RANGE: From 200 degrees to -200 degrees

PHASE ACCURACY: ± 10 degrees

PHASE RESOLUTION:

Display: 50 degrees/major division

Marker: 1 degree

TRANSFER FUNCTION

TRANSFER FUNCTION MEASUREMENT MODES: Dual-channel 128 point transfer functions are measured.

TRANSFER FUNCTION DISPLAY MODES:

Log Amplitude: 10 dB/major division
2 dB/major division

Linear Amplitude: Constant floating point fraction/major division

Phase: Constant 50 degrees/major division

Linear Amplitude: Calibrated ranges of 4.0×10^8 full scale to 4.0×10^{-8} full scale in factor of 10 steps. The uncalibrated verniers provide continuous coverage between the factor of 10 steps.

Phase Display Range: +200 degrees to -200 degrees.

TRANSFER FUNCTION ACCURACY:

Amplitude: ± 0.8 dB

Phase: ± 5 degrees

TRANSFER FUNCTION MEASUREMENT RANGE:

Log Amplitude: Calibrated ranges of +160 dB full scale to -80 dB full scale in 10 dB steps. The uncalibrated verniers provide continuous coverage between the 10 dB steps.

TRANSFER FUNCTION RESOLUTION:

Log Amplitude: 0.1 dB with the marker

Linear Amplitude: 3 digit scientific notation with the marker

Phase: 1 degree with the marker

COHERENCE FUNCTION

COHERENCE FUNCTION MEASUREMENT MODE:

Dual-channel 128 point coherence functions are measured with RMS averaging only.

COHERENCE MEASUREMENT RANGE: The bottom display line is 0.0 and the top display line is 1.0.

COHERENCE FUNCTION RESOLUTION:

Display: 0.125/major division

Marker: 0.01

Table 1-5. Specifications (Cont'd).

TRIGGER

TRIGGER MODES:

Free Run: A new measurement is initiated by the completion of the previous measurement.

External: A rear panel switch allows new measurements to be initiated by an external TTL pulse.

Input Signal: A new measurement is initiated when the input signal meets the specified trigger condition.

TRIGGER CONDITIONS:

Signal Conditions: Triggering can be selected to occur on a positive or negative going transition through the trigger level. The trigger level is adjusted between the time record overload limits by a continuous vernier.

Single/Multiple Triggers: Single-shot triggering is specified by taking the instrument out of the REPETITIVE mode. The ARM control sensitizes the instrument to take another measurement in the non-repetitive mode.

INPUT CHANNELS

INPUT IMPEDANCE: $10^6\Omega \pm 5\%$ shunted by <60 pf from input high to low for less than 75% relative humidity.

DC ISOLATION: Input low may be connected to chassis ground or floated up to 30 volts to reduce the effects of ground loops on the measurement.

INPUT COUPLING: The input circuit may be AC or DC coupled. The low frequency 3 dB roll off of the AC coupling is <1 Hz.

COMMON MODE REJECTION:

50 Hz: >60 dB

60 Hz: >58 dB

INPUT CHANNEL CROSSTALK: <-140 dB between channels with 1 k Ω source impedance driving one channel and the other channel terminated in 1 k Ω .

OUTPUT SIGNALS

X-Y RECORDER:

Vertical: 0 to 5.25V $\pm 5\%$

Horizontal: 0 to 5.25V $\pm 5\%$

Impedance: 1 k Ω

Pen Lift: Contact closure during sweep.

NOISE SOURCE:

Periodic: Pseudorandom noise signal with spectral line spacings that match the calculated point spacing for the selected frequency span. The noise spectrum is band limited and band translated to match the selected measurement.

Random: Random noise signal; the noise spectrum is band limited and band translated to match the selected measurement.

Level: Vernier control from <10 mV to >500 mV RMS into a load of $\geq 50\Omega$.

Periodic Noise Frequency Response: ± 1 dB with UNIFORM PASSBAND SHAPE and -10 dBV level.

Impedance: $<2\Omega$

IMPULSE SOURCE: A TTL low to high pulse with a period equal to the time record length.

DISPLAY

CRT:

Screen Size: 11.9 cm (4.7 in.) wide by 9.6 cm (3.8 in.) high

Graticule: 10 major divisions horizontal by 8 major divisions vertical with internal illumination for CRT photography.

Text: Maximum of four 32 character lines of alphanumeric text.

ALPHANUMERIC ANNOTATION: Single or dual channel configuration, input or stored trace, frequency calibration, amplitude calibration, equivalent noise bandwidth, relative

or absolute marker frequency, relative or absolute marker phase, relative or absolute marker coherence, RMS noise density at the marker, time record collection time.

DISPLAY ACCURACY: Display accuracy is 3% of total height or width for $25 \pm 15^\circ\text{C}$. Note that if numeric readings are taken visually from the displayed trace, this factor must be added to the basic accuracy specification.

TRACE STORAGE: A maximum of two independent traces may be digitally stored and recalled. Annotation information is not stored with the traces.

Table 1-5. Specifications (Cont'd).

AVERAGE

AVERAGING MODES:

RMS: for each calculated frequency point the displayed amplitude is

$$\sqrt{\sum_i A_i^2(f)} \quad \text{and the phase is } \frac{1}{N} \sum_i \phi_i(f)$$

Peak: For each calculated frequency point the displayed amplitude is MAX $A_i(f)$ and the phase is the corresponding value for the retained amplitude point.

Time: For each time record point the amplitude is

$$\frac{1}{N} \sum_i A_i(t)$$

The averaged time record is transformed to give the corresponding amplitude and phase.

NUMBER OF AVERAGES: 4 to 256 in a binary sequence plus exponential. Exponential in the RMS mode gives a running average with new spectral data weighted 1/4 and the previous result by 3/4. Exponential in the peak mode gives a continuous peak hold operation.

REMOTE OPERATION

PROGRAMMING: All analyzer front panel controls except the CRT controls, NOISE SOURCE LEVEL and TYPE, TRIGGER LEVEL, AMPLITUDE VERNIERS, and GROUND ISOLATION are remotely programmable via the HP-IB.

DATA INPUT: Time records, amplitude and phase spectra, coherence functions, transfer functions and alphanumeric text can be input to the analyzer via the HP-IB.

DATA OUTPUT: Time records, amplitude and phase spectra, coherence functions, transfer functions, alphanumeric text, marker values and control settings can be output via the HP-IB.

GENERAL

ENVIRONMENTAL:

Operating Temperature: 0°C to +55°C

Non-operating Temperature: -40°C to +75°C

Humidity: to 95% relative humidity at 40°C.

Operating Altitude: 4600 Meters (15,000 feet)

Non-operating Altitude: 6300 Meters (25,000 feet)

Shock: 30 G, 11 Msec half sine wave on each of six sides.

Vibration: 10 Hz to 55 Hz at 0.010 inch peak-to-peak excursion.

OPERATING POWER: Switch selection of 110V +5, -10% or 230V +5, -10% or 230V +5, -10% 48-66 Hz; less than 150 VA.

PHYSICAL PARAMETERS:

Size: 425.5 mm (16.75 inches) wide
552.5 mm (21.75 inches) deep
188 mm (7.4 inches) high

Net Weight: 24.5 kg (54 lbs.).

Shipping Weight: 29 kg (63 lbs.).

SECTION II INSTALLATION

2-1. INTRODUCTION.

2-2. This section contains instructions for installing and interfacing the Model 3582A Spectrum Analyzer. Included are initial inspection procedures, power and grounding requirements, environmental requirements, installation instructions, interfacing procedures and instructions for repacking and shipment.

2-3. INITIAL INSPECTION.

2-4. This instrument was carefully inspected both mechanically and electrically before shipment. It should be free of marks or scratches and in perfect electrical order upon receipt. To confirm this, the instrument should be inspected for physical damage incurred in transit. If the instrument was damaged in transit, file a claim with the carrier. Check for supplied accessories (listed in Section I) and test the electrical performance using the Operational Verification given in Section III Part III. If there is damage or deficiency, see the warranty in the front of this manual.

2-5. POWER REQUIREMENTS.

2-6. The Model 3582A can be operated from any power source supplying 100 V, 120 V, 220 V or 240 V (-10% to +5%), 48 Hz to 66 Hz single phase. Power consumption is less than 150 VA.

2-7. Line Voltage and Fuse Selection.

2-8. Figure 2-1 gives information for line voltage and fuse selection. The line voltage and proper fuse have been factory selected for 120 V ac operation.

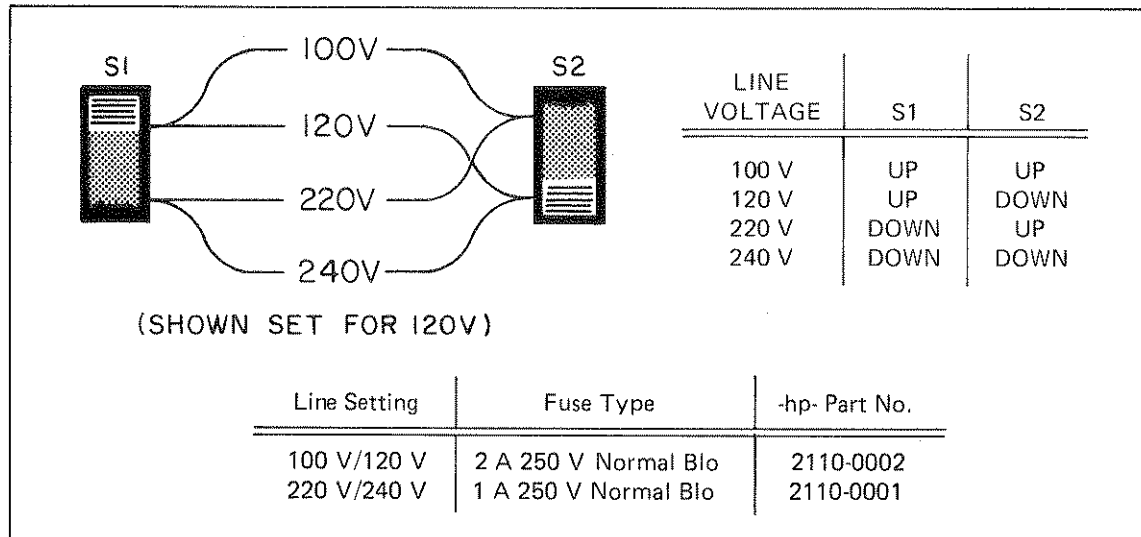

Figure 2-1. Line Voltage and Fuse Selection.

2-9. Power Cable and Grounding Requirements.

2-10. To protect operating personnel, the National Electrical Manufacturer's Association (NEMA) recommends that the instrument panel and cabinet be grounded. The Model 3582A is equipped with a three-conductor power cord which, when plugged into an appropriate receptacle, grounds the instrument cabinet. The type of power cable plug shipped with each instrument depends on the country of destination. Refer to Figure 2-2 for the part number of the power cable and plug configurations available.

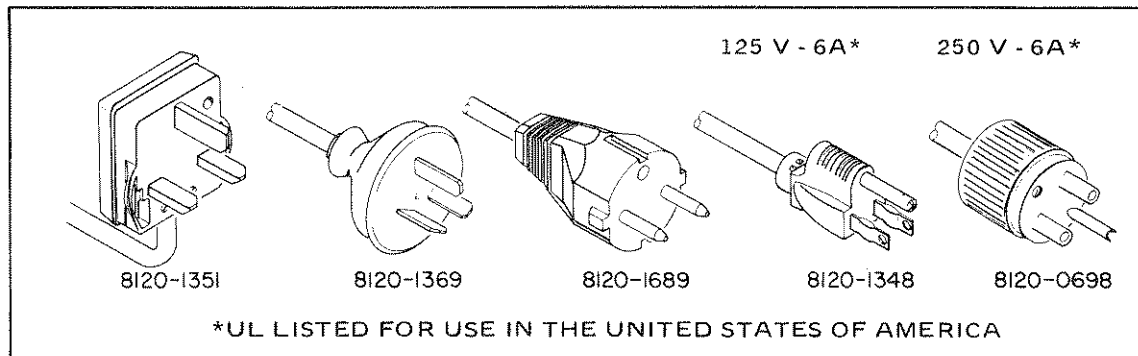

Figure 2-2. Power Cables.

2-11. OPERATING ENVIRONMENT.

2-12. Temperature.

2-13. The instrument may be operated in temperatures from 0°C to +55°C.

2-14. Humidity.

2-15. The instrument may be operated in environments with humidity up to 95%. However, the instrument should be protected from temperature extremes which cause condensation within the instrument.

2-16. Altitude.

2-17. The instrument may be operated at altitudes up to 4600 meters (15,000 feet).

2-18. Cooling Fan.

2-19. The 3582A is equipped with a cooling fan mounted on the rear panel. The instrument should be mounted so that air can freely circulate through it. The filter for the cooling fan can be removed and cleaned by flushing with soapy water.

2-20. Thermal Cutout.

2-21. The 3582A is equipped with a thermal cutout switch which automatically removes line voltage whenever the internal temperature becomes excessive. The temperature at which this will occur is dependent upon line voltage and airflow but with proper airflow will not occur in less than a 55°C ambient at high line. The switch resets automatically when the instrument cools. If a thermal cutout occurs, check for fan stoppage, clogged fan parts and other conditions that could obstruct airflow or otherwise cause excessive heating.

***NOTE**

The thermal cutout will operate at any external temperature down to +15° C if the airflow is blocked.

2-22. INSTALLATION.**2-23. Mounting.**

2-24. The 3582A is shipped with plastic feet and tilt stand in place, ready for use as a bench instrument. The plastic feet are shaped so that the 3582A may be mounted on top of other -hp- equipment. Plastic feet mounted on the rear panel enable the 3582A to be placed in a vertical position if desired. When operating the instrument, choose a location that provides at least three inches of clearance at the rear and at least one inch for each side. Failure to provide adequate air clearance will result in excessive internal temperature, reducing instrument reliability. The clearances provided by the plastic feet in bench stacking and the filler strip in rack mounting allow air passage across the top and bottom cabinet surfaces.

2-25. Option 908 (Rack Mount Kit) enables the 3582A to be mounted in an equipment cabinet. The rack mount for the 3582A is an EIA standard width of 19 inches. Installation instructions are included with the Rack Mount Kit. Option 908 may be ordered from the nearest -hp- Sales and Service Office under -hp- part number 5061-0078.

2-26. HP—IB SYSTEM INTERFACE CONNECTIONS.

2-27. The Model 3582A instrument is compatible with the Hewlett-Packard Interface Bus (HP—IB).

NOTE

The HP—IB is Hewlett-Packard implementation of IEEE std. 488-1975, "Standard Digital Interface for Programmable Instrumentation".

2-28. The instrument is connected to the HP—IB by connecting an HP—IB interface cable to the connector located on the rear panel. Figure 2-3 illustrates a typical HP—IB System interconnection.

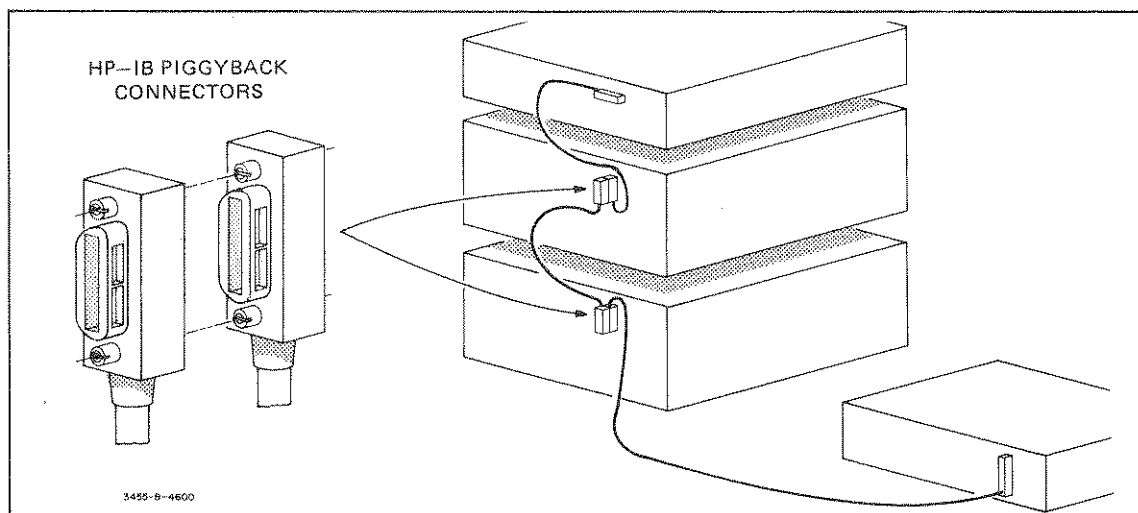

Figure 2-3. Typical HP—IB System Interconnection.

2-29. With the HP—IB system, you can interconnect up to 15 HP—IB compatible instruments. The -hp- 10631 HP—IB cables have identical “piggy-back” connectors on both ends so that several cables can be connected to a single source without special adapters or switch boxes. You can interconnect system components and devices in virtually any configuration you desire. There must, of course, be a path from the calculator (or other controller) to every device operating on the bus. As a practical matter, avoid stacking more than three or four cables on any one connector. If the stack gets too long, any force on the stack produces great leverage which can damage the connector mounting. Be sure that each connector is firmly screwed in place to keep it from working loose during use. The 3582A uses all the available HP—IB lines, therefore, any damaged connector pins may adversely affect HP—IB operation (see Figure 2-4).

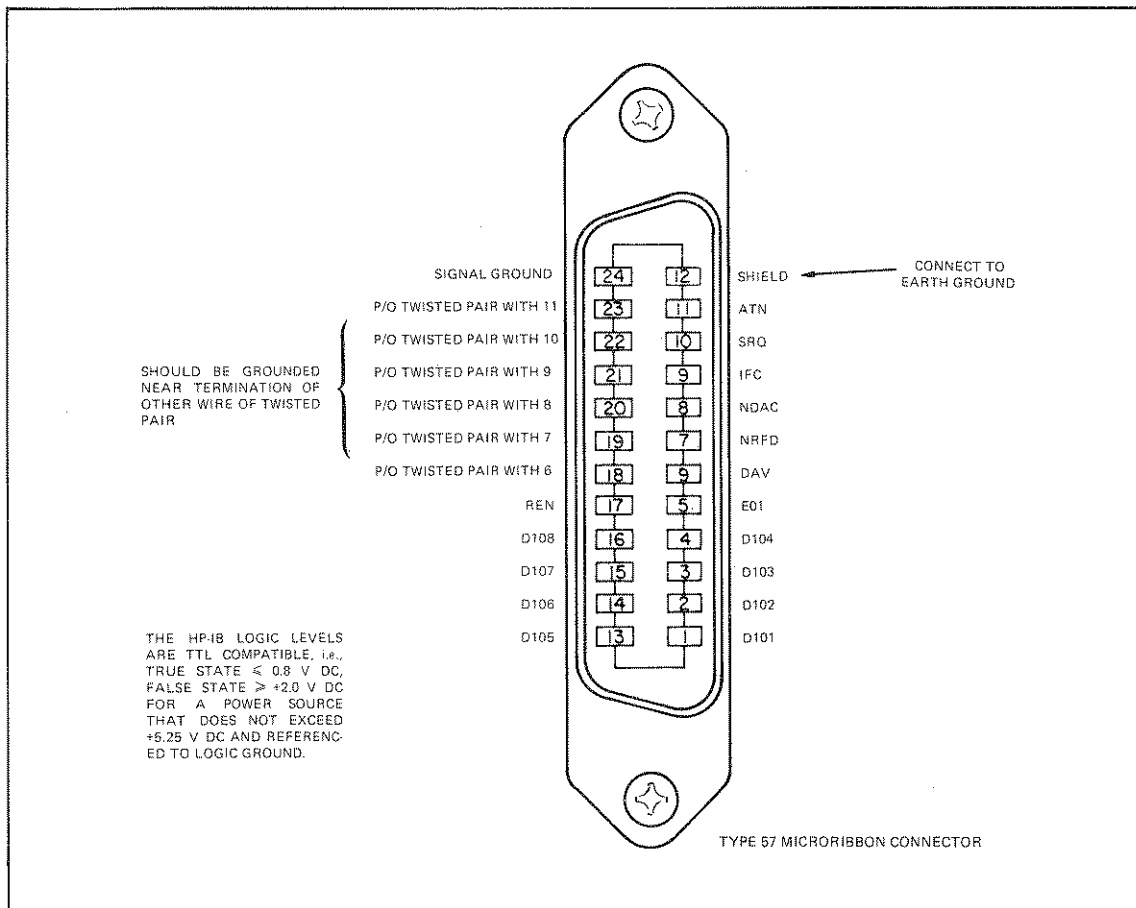

Figure 2-4. HP—IB Connector.

2-30. Cable Length Restrictions.

2-31. To achieve design performance with the HP—IB, proper voltage levels and timing relationships must be maintained. If the system cable is too long, the lines cannot be driven properly and the system will fail to perform (see Table 2-1 for HP—IB cable lengths). Therefore, when interconnecting an HP—IB system, it is important to observe the following rules:

- a. The total cable length for the system must be less than or equal to 20 meters (65 feet).
- b. The total cable length for the system must be less than or equal to 2 meters (6 feet) times the total number of devices connected to the bus.

Table 2-1. HP—IB Cables.

HP—IB Cable	Length
10631A	3 feet
10631B	6 feet
10631C	12 feet

2-32. HP—IB Address Selection.

2-33. The “talk” and “listen” addresses for the instrument are selected by the Instrument Bus Address switch. This switch is the seven section “DIP” switch located on the A2 HP—IB board under the front right card nest cover in the instrument. The five switches labeled 1 through 5 are used to select the unique talk and listen address. The instrument may be left at its factory settings of +K for the talk and listen address or it may be set to any of the alternate settings available. Refer to Table 2-2 for the available address codes and the corresponding switch settings.

NOTE

The 5-bit decimal code, consisting of bits A1 through A5, is often used by controllers which use this code convention as a System Device Number for instruments.

Table 2-2. Address Selection.

ASCII Code Character		Address Switches					5-bit Decimal Code
Listen	Talk	A5	A4	A3	A2	A1	
SP	@	0	0	0	0	0	00
!	A	0	0	0	0	1	01
"	B	0	0	0	1	0	02
#	C	0	0	0	1	1	03
\$	D	0	0	1	0	0	04
%	E	0	0	1	0	1	05
&	F	0	0	1	1	0	06
'	G	0	0	1	1	1	07
(H	0	1	0	0	0	08
)	I	0	1	0	0	1	09
*	J	0	1	0	1	0	10
+	K	0	1	0	1	1	11
,	L	0	1	1	0	0	12
-	M	0	1	1	0	1	13
.	N	0	1	1	1	0	14
/	O	0	1	1	1	1	15
0	P	1	0	0	0	0	16
1	Q	1	0	0	0	1	17
2	R	1	0	0	1	0	18
3	S	1	0	0	1	1	19
4	T	1	0	1	0	0	20
5	U	1	0	1	0	1	21
6	V	1	0	1	1	0	22
7	W	1	0	1	1	1	23
8	X	1	1	0	0	0	24
9	Y	1	1	0	0	1	25
:	Z	1	1	0	1	0	26
;	[1	1	0	1	1	27
<	\	1	1	1	0	0	28
=]	1	1	1	0	1	29
>	~	1	1	1	1	0	30

1 POSITION (UP)
0 POSITION (DOWN)

2-34. STORAGE AND SHIPMENT.**2-35. Environment.**

2-36. The instrument may be stored or shipped in environments within the following limits:

Temperature	-40°C to +75°C
Humidity	Up to 95%
Altitude	Up to 7,630 meters (25,000 feet)

The instrument should also be protected from temperature extremes which cause condensation within the instrument.

2-37. Packaging.

2-38. Original Packaging. Containers and materials identical to those used in factory packaging are available through Hewlett-Packard offices. If the instrument is being returned to Hewlett-Packard for servicing, attach a tag indicating the type of service required, return address, model number, and full serial number. Also, mark the container FRAGILE to ensure careful handling. In any correspondence, refer to the instrument by model number and full serial number.

2-39. Other Packaging. The following general instructions should be used for repacking with commercially available materials:

- a. Wrap the instrument in heavy paper or plastic. (If shipping to a Hewlett-Packard office or service center, attach a tag indicating the type of service required, the return address, the model number, and the full serial number.)
- b. Use a strong shipping container. A double-wall carton made of 350-pound test material is adequate.
- c. Use a layer of shock-absorbing material 70 to 100 mm (3 to 4 inch) thick around all sides of the instrument to provide firm cushioning and prevent movement inside of the container. Protect the control panel with cardboard.
- d. Seal shipping container securely.
- e. Mark shipping container FRAGILE to ensure careful handling.
- f. In any correspondence, refer to the instrument by model number and full serial number.

WARNING

The Model 3582A is not intended for outdoor use. Do not expose it to rain or other excessive moisture.

SECTION III PART I MANUAL OPERATION

3-1. INTRODUCTION.

3-2. This section contains the complete operating instructions as they relate to manual operation. Remote operating instructions, such as those from the HP-IB, are contained in Section III, Part II. Included in this section are the turn-on procedure, a description of the 3582A, a familiarization exercise, and specific operating data.

3-3. CONTROLS, CONNECTORS, AND INDICATORS.

3-4. On the foldout at the end of Section III is an illustration of all front and rear panel controls, connectors and indicators. The description of each item is keyed to the drawing within the figure.

NOTE

To permit maximum CRT life, always turn the instrument power LINE switch or the intensity control to OFF when the instrument is not in use for extended periods.

3-5. TURN-ON PROCEDURE.

3-6. If you have never used the 3582A, you are probably anxious to get started. Notice that the 3582A front panel switches are arranged in functional groups. The pushbuttons in each group are either momentary contact or push to turn on and push to turn off. Framed functions in some groups may be placed in the ON position to establish a basic turn-on mode of operation. If an apparent operating difficulty arises due to the inadvertent setting of switches or power line fluctuations, resetting the instrument to the basic turn-on mode and pressing the RESET button (colored orange) will often solve the problem (see the instrument pullout card). Preset the front panel switches for turn-on as follows:

Button Positions: ON OFF

Set both framed buttons.....	ON
Set AMPLITUDE A.....	ON
Set SCALE 10 dB/DIV.....	ON
Set AVERAGE NUMBER 4.....	ON
Set PASSBAND SHAPE.....	FLAT TOP
Set all other buttons.....	OFF
AMPLITUDE REFERENCE LEVEL.....	NORM
FREQUENCY MODE.....	0-25 kHz
TRIGGER LEVEL.....	FREE RUN
INPUT CHANNEL A SENSITIVITY.....	30 dBV
VERNIER.....	CAL
INPUT CHANNEL B SENSITIVITY.....	30 dBV
VERNIER.....	CAL
INPUT MODE.....	A

3-7. Connect the 3582A to a suitable power source (see Section II, Installation). Set the LINE switch to the ON position. While the instrument is warming up (allow 1 or 2 minutes), read the following information about spectrum analyzers and the description of the 3582A.

3-8. ABOUT SPECTRUM ANALYZERS.

3-9. The first spectrum analyzers were introduced during World War II for use in the development of pulse radar systems. Early spectrum analyzers were difficult to operate and interpret since they lacked such refinements as calibrated controls. They were, however, adequate tools which enabled scientists to observe the spectra of radar pulses and subsequently optimize the gain and bandwidth of radar receivers. Since that time, spectrum analyzers have evolved into general purpose instruments with unlimited applications. The 3582A is a low frequency spectrum analyzer designed for use below 25 kHz.

3-10. A COMPARISON.

3-11. Most low frequency spectrum analyzers use analog circuits to sweep the frequency band of interest and display the spectral components. This may require complex analog circuits with many associated adjustments to assure good signal analysis. Also, High Q circuits required for narrow bandwidths have long settling times resulting in slow operation.

3-12. In contrast, the 3582A converts the analog input signal into discrete digital data through a sampling process. This data is then processed by a unique "digital filter" to obtain the frequency band of interest before it is stored in memory for analysis. A "computer-like" processor performs a Discrete Fast Fourier Transform and other mathematical operations on the stored data allowing the 3582A to display a great variety of information in a timely manner. For example, the 3582A will provide spectral data at greater than 100 times the speed of the -hp- 3580A Spectrum Analyzer (using conventional swept L.O. techniques) for narrow bandwidths.

3-13. FEATURES.

3-14. The 3582A, because of its digital design, offers many operating features not found in "conventional" spectrum analyzers. Some of the more prominent features are listed in Operating Features on the following page.

3-15. THE DISPLAY.

3-16. The display on the 3582A contains both alphanumeric and graphical data. The graphical display of spectra is discrete in nature and is presented as a series of line segments connecting discrete data points.

3-17. There are many problems associated with changing continuous waveforms into discrete data. Sampling processes and finite measurement times generate some extraneous information which effect frequency analysis operations and may appear as undesirable display data. These display aberrations become more pronounced when a narrow passband is used and the frequency is shifted slightly. The effects of discrete measurements are explained in more detail in Simplification of Discrete Data Analysis.

OPERATING FEATURES

<p>Frequency Range: .02 Hz to 25 kHz</p> <p>Amplitude Range: 3 mV to 30 V maximum input</p> <p>Display Range: 80 dB (dynamic range > 70 dB)</p> <p>Display: Two channel input and capability of displaying or storing two traces simultaneously. The traces may contain the following information.</p> <ol style="list-style-type: none"> 1. Phase: either or both channels 2. Amplitude: either or both channels 3. Phase Transfer Function 4. Amplitude Transfer Function 5. Coherence 6. Time Function: either channel can be displayed but not stored <p>Zoom: Zoom can expand any portion of the display to a maximum of .5 Hz/cm</p> <p>Marker: Manually moveable marker can be used for determining frequency, amplitude, and phase on any point of the selected spectrum. The marker is not usable on stored traces.</p> <p>Averaging: RMS and Time averaging functions and selectable averaging cycles. Also there is a Peak hold mode.</p> <p>Noise Source: Amplitude adjustable (periodic or random)</p>	<p style="text-align: center;">NOTE</p> <p><i>Random noise source is not available on instruments with serial numbers prefixed 1747A.</i></p> <p>Noise Measurement: Volts/$\sqrt{\text{Hz}}$ can be measured directly</p> <p>Filter Shapes: Three selectable filter (PASSBAND) shapes:</p> <ol style="list-style-type: none"> 1. Flat Topped: Best for measuring accurate amplitude of discrete spectra. 2. Hanning: More selective than Flat Topped filter (narrower 3 dB passband) but less accurate. Better for frequency measurements where spectral amplitudes are relatively equal (within 50 dB). 3. Uniform: Useful for analyzing transients. Also the 3582A's Periodic Noise Source is optimized for this filter to improve analysis. <p>Filter Bandwidth: Automatically selected</p> <p>HP-IB: The Hewlett-Packard Interface Bus permits interconnection to a controller (such as the -hp- 9825A Calculator) and affords programmability plus data transfer capabilities.</p>
--------------------------------------------------------------------------------------------------------------------------------------------------------------------------------------------------------------------------------------------------------------------------------------------------------------------------------------------------------------------------------------------------------------------------------------------------------------------------------------------------------------------------------------------------------------------------------------------------------------------------------------------------------------------------------------------------------------------------------------------------------------------------------------------------------------------------------------------------------------------------------------------------------------------------------------------------------------------------------------------------------------------------------------------------------------------------------------------------------------------	------------------------------------------------------------------------------------------------------------------------------------------------------------------------------------------------------------------------------------------------------------------------------------------------------------------------------------------------------------------------------------------------------------------------------------------------------------------------------------------------------------------------------------------------------------------------------------------------------------------------------------------------------------------------------------------------------------------------------------------------------------------------------------------------------------------------------------------------------------------------------------------------------------------------------------------------------------------------------------------------------------------------------------------------------------

3-18. The discrete display may appear somewhat different from conventional spectrum analyzers, however, the locus of all points represented by the graphical display will be accurate within the specifications for the mode of operation selected.

3-19. FAMILIARIZATION EXERCISE.

3-20. Introduction.

3-21. The familiarization exercise is intended to give the user a general introduction to the instrument controls and their functions. The exercise will begin with simplified displays of data and proceed to the more complex modes of operation and data display. To help facilitate making sample measurements, a 10 k Ω resistor, a 3000 pF capacitor, and a function generator will be required (suggestion: a Hewlett-Packard 3312A Function Generator will provide all the necessary output signals). To avoid confusion, follow the procedures and switch settings in the order given.

3-22. Adjusting the Display.

3-23. The 3582A should already be set up in the basic turn-on mode as indicated in the Turn-On Procedure. Press the SCALE 2 dB/DIV button and set CHANNEL A and B SENSITIVITY to CAL. Adjust the INTENSITY and FOCUS to obtain a well defined trace. An ASTIG (astigmatism) control is provided, but adjustment is only necessary if the FOCUS control cannot produce a clear display. The trace being displayed is the channel A calibration signal.

3-24. The CAL Signal.

3-25. An internal calibration signal is provided to check instrument operation and is switched into the input circuits whenever the CHANNEL A or CHANNEL B SENSITIVITY control is placed in the CAL position. A display of spectral lines, which have an amplitude of 22 dBm (or 20 V in LINEAR mode) and are 1 kHz apart, serve as a quick reference for verifying the amplitude and frequency calibration of the instrument (see Figure 3-1). These non-equivalent levels result in displays of exactly half full scale for LINEAR and 2 dB/DIV display settings. To display the channel B CAL signal, make the following switch changes:

DISPLAY AMPLITUDE A.....OFF
 DISPLAY AMPLITUDE B.....ON

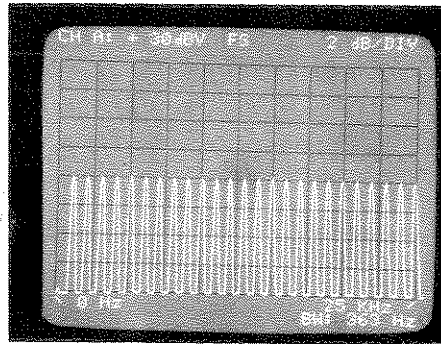

Figure 3-1. The Channel A CAL Signal.

3-26. Notice that the display message indicates that an invalid condition exists. This is one of several messages that help to insure proper instrument operation. To continue though, place the INPUT MODE switch to the B position to obtain the correct display.

3-27. The Input Mode Switch.

3-28. The INPUT MODE switch position establishes one or two channel operation. Because the display and analysis techniques are discrete and the amount of memory space limited, the number of displayed data points are divided in half for two channel operation. As a result of this division, the instrument doubles the bandwidth even though the SPAN setting remains the same. To observe this condition on the display, slowly alternate the INPUT MODE switch between B and BOTH. Reset the following switches:

DISPLAY AMPLITUDE B.....OFF
 DISPLAY AMPLITUDE A.....ON
 INPUT MODE.....A

3-29. Input Considerations.

3-30. Voltage Limitations. Before connecting any device to the input terminals, be aware of the maximum voltages which are marked on the Front Panel and listed as follows:

MAXIMUM INPUT VOLTAGE..... 100 V rms or \pm 100 Vdc
 MAXIMUM ISOLATION VOLTAGE..... 30 V MAX

3-31. AC-DC Coupling. A front panel slide switch selects ac or dc coupling. AC coupling is useful for analyzing signals which have a high dc offset. Note that the absolute value of the dc offset plus the absolute value of the peak voltage of the signal must be less than 100 V dc. This capacitive type of coupling acts like a high pass filter which has a -3 dB point at .5 Hz. DC coupling has the widest area of applications and the 0 Hz frequency spectral component is presented on the display when the range of frequencies selected include 0 Hz but do not use the dc component to measure dc as some inaccuracies may result. Set the following switches:

A COUPLING..... (dc)
 B COUPLING..... (dc)

3-32. Input Isolation. The input section of the 3582A can be isolated to permit measurements where ground loops may be present. When the ISOL-CHAS switch is in the CHAS position, the lower (black)-input terminal is connected to the chassis which in turn is connected to the power system ground through the offset pin on the power plug. It is not advisable to isolate the chassis through a power plug adapter which would, in effect, render the instrument in an unsafe condition. When the ISOL-CHAS switch is set to ISOL, it disconnects the input low from chassis ground; the maximum isolation voltage must not be greater than 30 V max above the chassis potential (0 V). Set the following switch:

ISOL-CHAS CHAS

3-33. Balance Adjustments. Balance adjustments (BAL) are provided for each channel and may be used to change the dc offset voltage output of the input amplifiers. Under normal operating conditions, no change in the BAL setting is required. However, the BAL adjustment may be made for each setting of the INPUT SENSITIVITY switches. Specific instructions for setting the BAL adjustment are given under Front Panel Screwdriver Adjustment.

NOTE

The dc balance, if it is far out of adjustment, may cause a premature overload condition.

3-34. Analyzing an Input Signal.

3-35. Connecting the Input. Set the controls on the function generator for a 1 kHz square wave output. Connect this output to the channel A input of the 3582A (a shielded cable with suitable connectors is recommended, but not mandatory). Make the following switch changes:

CHANNEL A SENSITIVITY.....30 dBV
 DISPLAY SCALE.....10 dB/DIV

3-36. Setting the Input Sensitivity. Adjust CHANNEL A SENSITIVITY to achieve an approximately full scale display without overloading the input. The input amplitude will be referenced to a calibrated full scale amplitude on the display (see Figure 3-2). Each INPUT SENSITIVITY switch has a concentric control which is an 11 dB attenuator. This may be used to decrease the signal amplitude between INPUT SENSITIVITY ranges, however, the displayed amplitude will not be referenced to a calibrated full scale amplitude. It is always a good operating procedure to set the INPUT SENSITIVITY switch to its least sensitive position and then increase the sensitivity to obtain an adequate display amplitude. The OVERLOAD light will indicate if the input magnitude is too large. An indication on the alphanumeric portion of the display will appear if an overload condition occurs during the period when data is being taken. (There could be a possible overload in the data.)

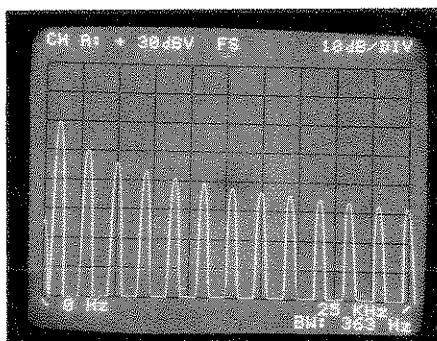

Figure 3-2. Spectrum of a 1 kHz Square Wave.

3-37. The Triggering Controls. The triggering controls determine when the input signal will start to be sampled for analysis. The input trigger is derived from one of the following sources:

- a. A signal level on channel A input.
- b. An external TTL level input on the rear panel.

3-38. When data is being taken, the DATA LOADING annunciator will be on. The LEVEL control in combination with the SLOPE switch determine the portion of the wave shape which will initiate a trigger. When the LEVEL control is in the FREE RUN position, data will be taken as fast as it can be processed. The REPETITIVE switch, when placed in the off position, places the instrument in a single scan mode of operation. In this mode a trigger can be generated as described above, but only after the trigger circuits are enabled by an arm command generated by pressing the ARM button. An annunciator light, located adjacent to the ARM button, indicates when an arm command has been initiated. Try the following procedure:

- a. Move the LEVEL control out of FREE RUN to the approximate center position. A trigger initiated by the input signal will continue the scan operation.
- b. Set REPETITIVE to OFF for single scan operation.

c. To initiate a scan, press the ARM button. A single scan will take place almost immediately.

d. Make the following switch changes:

LEVEL.....FREE RUN
 REPETITIVE.....ON

NOTE

The FREE RUN position is framed to draw attention to it. If the TRIGGER LEVEL is inadvertently left on and an appropriate input signal is not available, the instrument will stop taking data and appear to be "hung up".

3-39. Marker Controls. The 3582A has a unique movable marker which is set by the POSITION control. The marker frequency is displayed in addition to three amplitude functions:

- a. Normal marker amplitude.
- b. Amplitude of noise in the equivalent noise bandwidth ($\div\sqrt{BW}$).
- c. Relative amplitude (the frequency is also relative (REL)).

3-40. Normal Marker Amplitude. Set the MARKER ON switch to ON. A bright dot will appear on the trace. Rotate the POSITION control to place the marker at a point of interest. In Figure 3-3 the marker has been set on the 1 kHz spectral line.

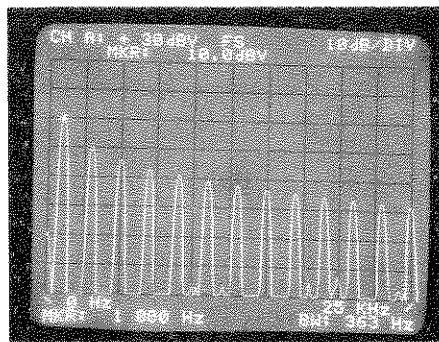

Figure 3-3. Setting the Marker Position.

3-41. Equivalent Noise Bandwidth. The \sqrt{BW} button is used for making measurements of random noise. Normally the noise level measured at any point with the analyzer is a function of the filter bandwidth and the actual noise density. Since different filter bandwidths will give different answers, the comparison of results is difficult. In order to eliminate this problem, it is customary to normalize out the bandwidth factor by dividing the reading by the square root of the "equivalent noise bandwidth". This is the width of an ideal rectangular filter with the same power response as the actual filter used. The \sqrt{BW} function performs this normalization automatically and presents the results directly in dBV/\sqrt{Hz} or voltage \sqrt{Hz} . To observe this function set the \sqrt{BW} button to ON; when finished, set the button to OFF.

3-42. Relative Amplitude. The SET REF button enters a reference amplitude and frequency into memory of comparison to the present marker reading (see Note). This reference remains in memory until the SET REF button is pressed again establishing a new reference. Press the SET REF button.

NOTE

The relative marker reading is the ratio of the present amplitude reading to the previous amplitude reading. Units for the various marker functions will be displayed accordingly. In the relative mode, an error will result if the SCALE is changed between LINEAR and LOG.

3-43. To read a relative amplitude and frequency, set the REL button to the ON position. The display will now present the relative frequency and amplitude of the present marker position. Move the MARKER POSITION to observe a new relative reading. Set the REL button to OFF.

3-44. Switching the Marker to a Different Trace. When two traces are being displayed, the TRACE button causes the marker to be moved from one trace to another. Note that if the REL button is on, relative comparisons between the two traces can be made. Dual trace operation and examples of marker functions will be given later.

3-45. Setting a Frequency Reference for Band Analysis Modes. Move the marker to the 1 kHz spectral line as in Figure 3-3. Press SET FREQ to load the marker frequency, as a reference, into memory for a new start or center frequency in the band analysis modes.

3-46. The Frequency Span Controls.

3-47. The Mode Switch. The Mode switch can select one of four different types of frequency displays. Two of the types of displays will be referred to as the base band mode because the frequencies displayed begin at 0 Hz and end at some upper frequency. The 0-25 kHz position permits an overall view of the frequency spectrum and provides a quick reference to return to if a spectral line is lost while searching at narrow bandwidths in other modes. The 0 START position provides for high resolution near the 0 Hz frequency point using the span selector to set the upper frequency limit.

3-48. The other two types of displays will be referred to as the band analysis modes because a segment or band of frequencies within the 0-25 kHz range may be observed. Switching to either SET START or SET CENTER, allows for the use of a variable frequency control which tunes the digital local oscillator. Rotating the control changes the starting frequency or the center frequency so that spectral lines may be placed at any horizontal position on the display. START or CENTER frequency may also be selected using the MARKER SET FREQ button. Set the following switch:

MODE.....SET CENTER

3-49. The 1 kHz spectral line should now be in the center of the display. Rotate the ADJUST control to see how the center frequency is changed. For more detailed analysis, the SPAN may be reduced thereby expanding (or zooming in) on the frequencies of interest.

3-50. The SPAN Control. The SPAN switch controls the displayed span. The bandwidth is adjusted automatically and is also dependent upon the position of the DISPLAY MODE switch. The narrowest bandwidths are available in the 0 START mode and single channel mode for any PASSBAND SHAPE selected. When using SET START or SET CENTER, all span settings are available for use except the two narrowest spans (1 Hz and 2.5 Hz). Set the following switch:

SPAN.....250 Hz

3-51. In the example presented by Figure 3-4, reducing the span permitted two sidebands to be resolved which were formerly included in the wider 25 kHz span. The use of the MARKER controls showed that the sidebands were 40 Hz away from the center frequency with a relative amplitude of -20.0 dB.

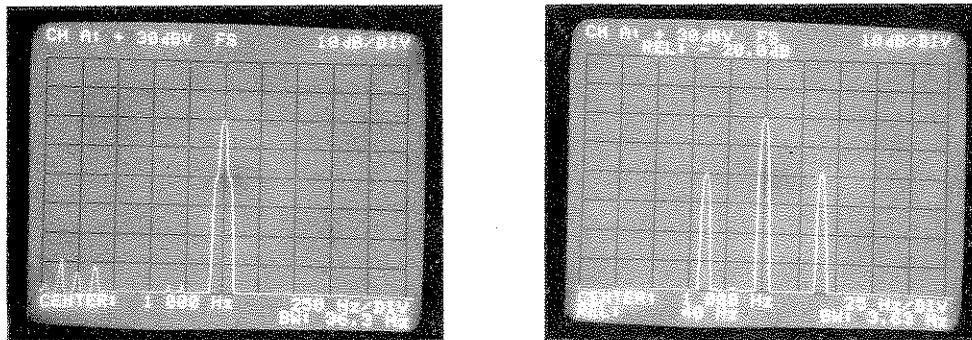

Figure 3-4. Using the SPAN Control to Resolve Sidebands.

3-52. If the function generator has modulating capabilities, pause to experiment with different modulating frequencies and amplitudes using the 3582A and the control information thus far presented to derive spectral data. When finished, reset the following switches (except the LINE switch):

- Set both framed functions.....ON
- Set SCALE 10 dB/DIV.....ON
- Set AVERAGE NUMBER 4.....ON
- Set PASSBANDSHAPE.....FLATTOP
- Set AMPLITUDE A.....ON
- Set all other buttons.....OFF
- AMPLITUDE REF LEVEL.....NORMAL
- FREQ SPAN MODE.....0-25 kHz
- TRIGGER LEVEL (framed).....FREE RUN
- INPUT CHANNEL A.....30dBV
- VERNIER.....CAL
- INPUT CHANNEL B.....30dBV
- VERNIER.....CAL
- INPUT MODE.....A

3-53. Scales.

3-54. One of three scales may be selected to represent display spectral amplitudes. Each scale may be used in combination with the channel SENSITIVITY switches and the

AMPLITUDE REFERENCE LEVEL switch to offset (log modes) or expand (linear mode) the display relative to full scale. There are three basic scale settings:

- a. 10 dB/DIV. The 10 dB/DIV scale is a logarithmic type of display which has a range of 80 dB.
- b. 2 dB/DIV. The 2 dB/DIV scale is a logarithmic type of display which has a range of 16 dB.
- c. LINEAR. The LINEAR scale has a range from the full scale indicated voltage to zero volts. Therefore, the volts per division decreases as the full scale amplitude is reduced. The SENSITIVITY switch indicates the maximum rms voltage level which does not exceed overload. The voltage level displayed is a calibrated voltage which can be easily divided among the eight graticule divisions. Because of this, some SENSITIVITY switch positions will give a displayed full scale voltage which will require the use of the AMPLITUDE REFERENCE LEVEL switch to give a full scale display.

3-55. Amplitude Reference Level.

3-56. The AMPLITUDE REFERENCE LEVEL switch has nine positions. In the NORM position, the amplitude reference level function is off. If the switch is turned clockwise, the following changes will take place on the display (NORM is position 1):

- a. Log Modes: The display is offset by an additional 10 dB/DIV for each position which can accumulate to a total of 80 dB.
- b. Linear Mode: Since the zero volts line is always at the bottom of the display, the full scale reference level will decrease thereby expanding or amplifying lower signal levels.

3-57. To observe the different SCALES and effects of the AMPLITUDE REFERENCE LEVEL switch, try the following exercise:

- a. Set the function generator for a 1 kHz square wave output. Adjust the amplitude to 3 V rms or less.
- b. Set the CHANNEL A SENSITIVITY for 10 dB.
- c. Readjust the amplitude of the function generator to achieve a full scale display without an overload indication.
- d. Rotate the AMPLITUDE REFERENCE LEVEL switch and observe how the display is shifted up in 10 dB increments.
- e. To expand a portion of the display, use the AMPLITUDE REFERENCE LEVEL switch to place that part of the display at or near the full scale graticule.
- f. Placing the 2 dB/DIV button to the ON position will expand the spectra within - 16 dB from the reference setting to a full scale display (see Figure 3-5).
- g. Return the AMPLITUDE REFERENCE LEVEL switch to NORM.

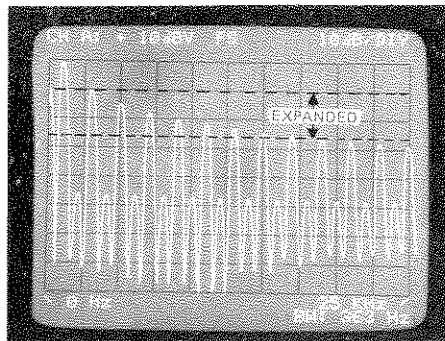

BEFORE OFFSET AND EXPANSION

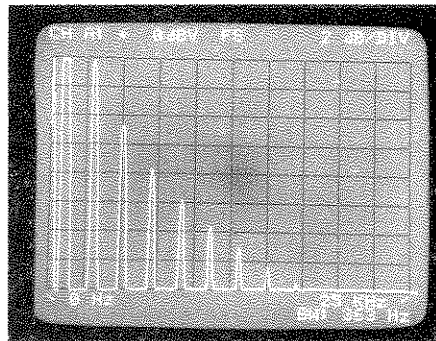

AFTER OFFSET AND EXPANSION

Figure 3-5. Expanding a Portion of the Display.

h. Press the LINEAR scale button and observe that the maximum allowable input signal on the 3 V range does not produce a full scale display. Notice that the calibrated reference level is 4 V (see Figure 3-6).

i. To observe the associated lower amplitude spectra, rotate the AMPLITUDE REFERENCE LEVEL switch. Notice that the volts/div decreases at each new reference level, thus expanding the amplitude of the spectra on the display.

j. Set the following switches:

10 dB/DIV.....ON
 AMPLITUDE REFERENCE LEVEL.....NORM



Figure 3-6. Full Scale Reference in the LINEAR Mode.

3-58. The Passband Shape Controls.

3-59. One of three passband shapes may be selected to characterize the signal data. Careful consideration should be given to the choice of PASSBAND SHAPE in order to maximize the spectral information displayed for a particular type of measuring application. The PASSBAND SHAPES are unique and are explained as follows:

a. FLAT TOP. The FLAT TOP passband is similar to those found in wave analyzers such as the -hp- 312D and the -hp- 310A. Its high shape factor and broad response make it

ideal for measuring the amplitude of individual spectra, such as that found in the output from an oscillator. Therefore it is the most accurate passband for measuring amplitude.

b. **HANNING.** The HANNING passband is similar to those found in swept frequency spectrum analyzers such as the -hp- 3580A. The HANNING passband is derived from a raised cosine shape which helps to give better resolution for isolating one spectral line in a closely spaced group of spectral lines, particularly when the amplitudes of the spectra are within 50 dB of each other. A good example of the use of this passband would be in deriving the spectrum for a notch filter. The HANNING passband should be selected when using the RANDOM NOISE SOURCE and when measuring discrete spectrum components. It is slightly less accurate (approximately -1 dB) than the FLAT TOP passband.

c. **UNIFORM.** The UNIFORM passband has a very narrow 3 dB bandwidth and should be used for measuring transient signals. The 3582A's PERIODIC NOISE SOURCE is optimized for this passband which aids in analyzing transfer characteristics of networks. The display aberrations are greatest when using this passband so caution should be used when measuring the amplitudes of individual spectra.

3-60. To observe the effects of using the different passband shapes on a spectral display, try the following exercise:

a. The 3582A should have the switches already set up from the last exercise. But if you are beginning here, set the switches to the basic turn-on mode as indicated in the Turn-On Procedure.

b. Set CHANNEL A SENSITIVITY to $+10$ dB.

c. Adjust the function generator for a 10 kHz sine wave and a full scale display on the 3582A (approximately 3 V). The spectrum should appear as in Figure 3-7.

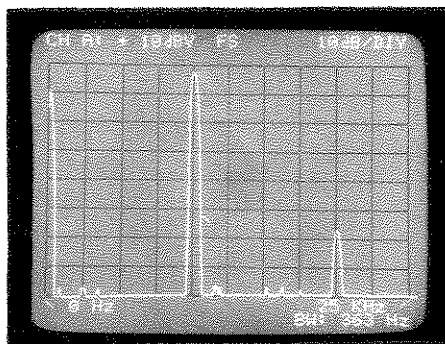

Figure 3-7. A Sine Wave Spectrum using the FLAT TOP Passband.

d. Change the frequency of the oscillator very slowly and notice that the spectral display retains its shape as it shifts across the screen.

e. Now set the HANNING passband button to ON. The spectrum should appear as in Figure 3-8.

f. Slowly change the frequency of the oscillator and observe how the spectral shape slightly changes proportions. Also notice that the bandwidth has decreased to less than one

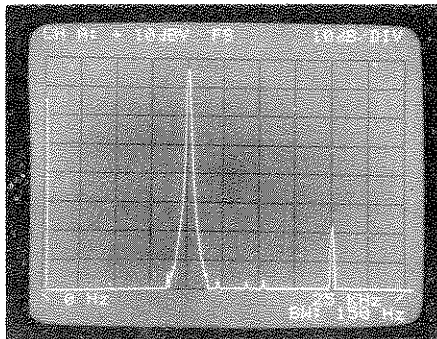

Figure 3-8. Sine Wave Spectrum using the HANNING Passband.

half its previous value. The smaller bandwidth allows for greater selectivity, while the slightly changing shape is due to the discrete sampling and display technique.

- g. Set the UNIFORM passband button to ON. The spectrum may appear as in Figure 3-9.

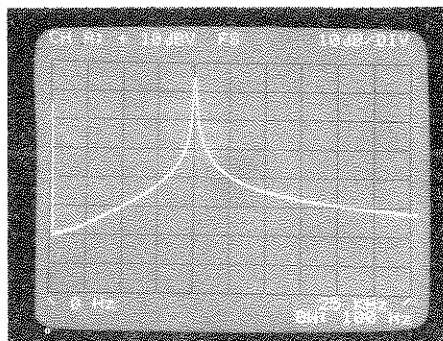

Figure 3-9. Sine Wave Spectrum Using the UNIFORM Passband.

h. Slowly change the frequency of the oscillator. The radically changing shape is due to a bandwidth which is now less than a third that of the FLAT TOP passband. This reveals that the UNIFORM passband should generally not be used except for measuring transfer functions using the PERIODIC NOISE OUTPUT as a source.

3-61. The NOISE SOURCE.

3-62. The NOISE SOURCE is a broadband periodic pseudo random signal. When "PERIODIC" is selected, the period is automatically adjusted so that one period covers one SPAN setting and, therefore, the periodicity does not effect the spectrum analysis. When "RANDOM" is selected, the periodicity of the noise source signal is extended to as much as 14 minutes. In this mode, the 3582A interprets the pseudo random signal as a band limited white noise source. The NOISE SOURCE output may be adjusted through the use of the LEVEL control located adjacent to it. The low impedance output (< 1 ohm) may be used as a source signal for analyzing two port networks.

3-63. To see the spectral output of the NOISE SOURCE, connect the NOISE SOURCE output to the channel A input connector via a shielded cable with suitable adapters. Set the

CHANNEL A COUPLING and the CHANNEL B COUPLING to AC. Adjust the CHANNEL A SENSITIVITY control for an on-scale display. The displayed spectrum is nearly a uniform amplitude across the frequency axis (see Figure 3-10[a]). It is important to note that there is energy at each spectral point, but none in between. If a phase spectrum is observed, the phase will be consistent for corresponding frequencies for each time record taken. Do not use SET START or SET CENTER for making measurements using the Periodic Noise Source within one SPAN width of 0 Hz. Instead, use the 0-START mode as this does not use the Digital Local Oscillator and will avoid L.O. translated noise aliasing around 0 Hz.

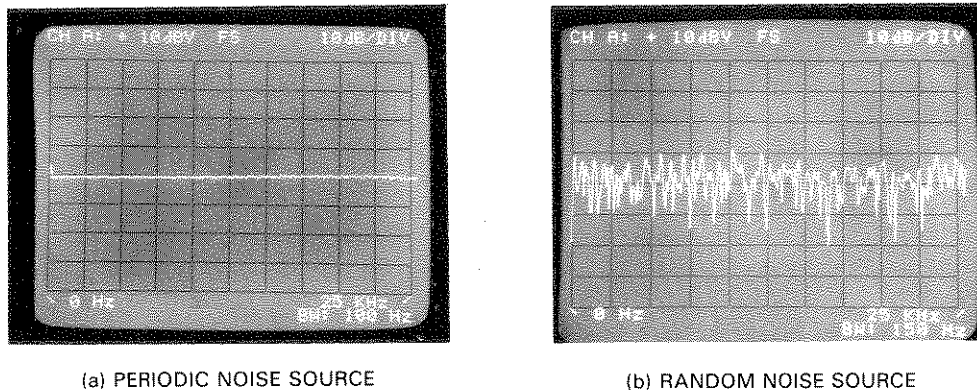

Figure 3-10. Noise Source Spectrums.

3-64. To see the spectral output of the RANDOM noise source, set the PASSBAND SHAPE to HANNING and turn the concentric control of the level switch to RANDOM. The spectrum will appear similar to that in Figure 3-10(b). A smoother display may be obtained by RMS averaging.

3-65. IMPULSE OUTPUT.

3-66. The IMPULSE output signal is a pulse which has an amplitude of +5 V. The period of the pulse is determined by the SPAN control settings (see Table 3-1). The repetition period is the same as the length of the time record. The UNIFORM window should be used

Table 3-1. Impulse Output Pulse Period.

SPAN	0-25 kHz 0-Start	SET START SET CENTER
25 kHz	1.211 μ sec	2.441 μ sec
10 kHz	2.441 μ sec	6.104 μ sec
5 kHz	6.104 μ sec	12.207 μ sec
2.5 kHz	12.207 μ sec	24.414 μ sec
1 kHz	30.518 μ sec	61.035 μ sec
500 Hz	61.035 μ sec	.12207 msec
250 Hz	.12207 msec	.24414 msec
100 Hz	.24414 msec	.6105 msec
50 Hz	.6105 msec	1.221 msec
25 Hz	1.221 msec	2.441 msec
10 Hz	2.441 msec	6.101 msec
5 Hz	6.101 msec	— — —
1 Hz	30.667 msec	— — —

when making measurements using the IMPULSE output as a source. The resulting spectrum has a constant amplitude and phase-frequency relationship.

3-67. To observe the IMPULSE spectrum, remove the NOISE SOURCE output from CHANNEL A and connect the IMPULSE output to CHANNEL A. Adjust the SENSITIVITY for an on-scale display. The spectrum will appear similar to that in Figure 3-10(a).

3-68. Dual Channel Measurements.

3-69. The dual channel capability makes the 3582A a very versatile instrument. With two channels, many measuring applications are possible including the measurement of the transfer characteristics of two port networks. One type of two port network is a single pole low pass filter, consisting of a series resistor and a parallel capacitor (see Figure 3-11).

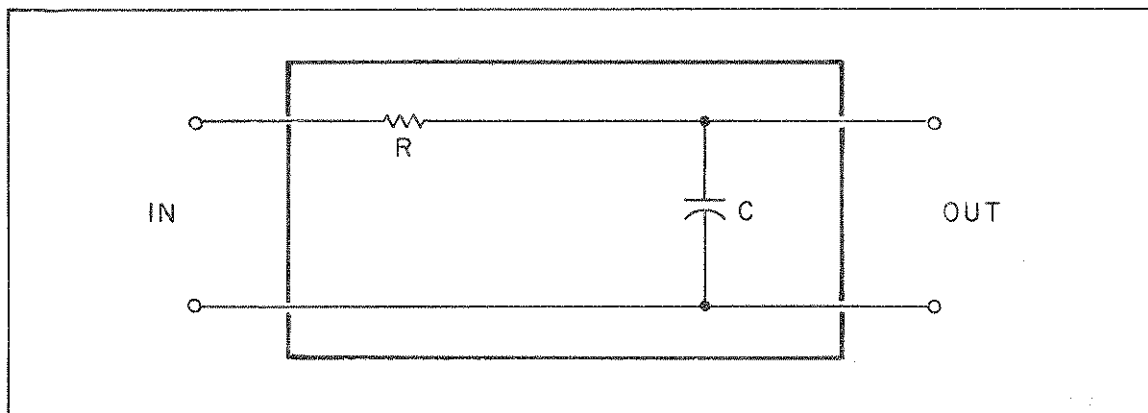

Figure 3-11. A Two Port Network.

3-70. A two port network such as this will be used to illustrate the amplitude and phase transfer measuring functions of the 3582A. To connect the filter:

- a. Remove the IMPULSE source from channel A.
- b. Connect a $10\text{ k}\Omega$ resistor and a 3000 pF capacitor between the inputs of channels A and B as shown in Figure 3-12.

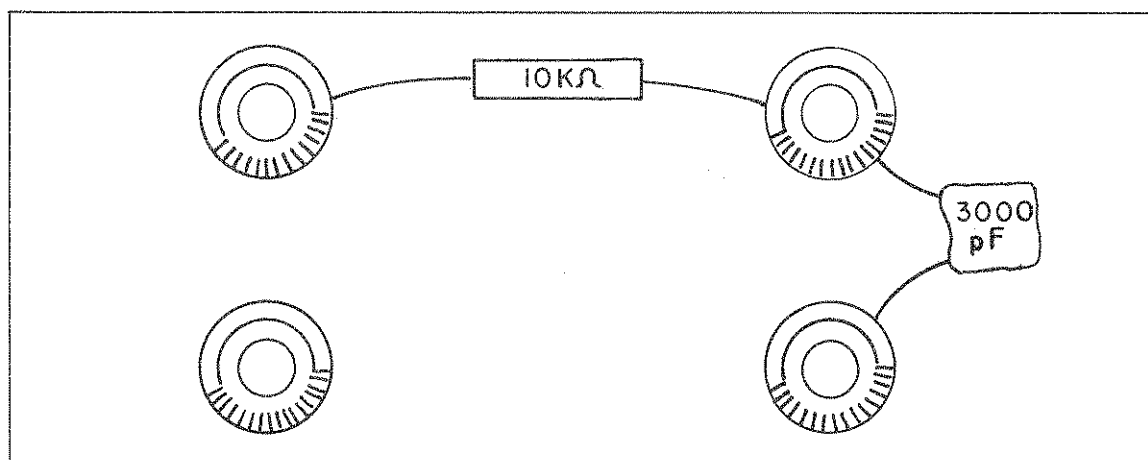

Figure 3-12. Connecting a Single Pole Low Pass Filter.

- 3-71. To observe both input A and input B, try the following exercise:
- a. Reconnect the NOISE SOURCE OUTPUT to channel A INPUT.
 - b. Verify that CHANNEL A and CHANNEL B COUPLING switches are set to AC and that the INPUT MODE switch is set to BOTH.
 - c. Set CHANNEL A and CHANNEL B SENSITIVITY switches for +10 dB.
 - d. Verify that the UNIFORM PASSBAND button is set to on and "PERIODIC" is selected.
 - e. Press channel A and channel B AMPLITUDE buttons to ON.
 - f. Adjust the AMPLITUDE REFERENCE LEVEL for a centered display.
 - g. The input and output of the low pass filter is described by the two traces and should appear similar to Figure 3-13.

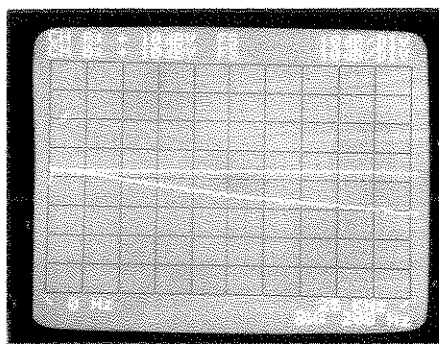

Figure 3-13. Input and Output Spectrum of a Low Pass Filter.

- h. Comparisons between the two traces can be made with the use of the MARKER functions.
 - i. Set the MARKER ON button to ON.
 - j. Set the MARKER to a desired reference point on the top trace using the POSITION control.
 - k. Press the MARKER REL button to ON.
 - l. Press the MARKER SET REF to load a relative reference into memory.
 - m. Pressing the MARKER TRACE button will now give relative amplitude information between the two traces.

3-72. Amplitude Transfer (XFR) Function. As already illustrated, comparative measurements can be used to determine the differences between channel A and channel B. If enough of these measurements are made, a graph may be constructed which would indicate the amplitude transfer characteristics of the network under analysis. The AMPLITUDE

XFR FCTN is a graphical display which is the result of dividing the spectrum of channel B by the spectrum of channel A. It is a continuous function which describes the gain or attenuation, as referenced to frequency, of a two port network. To observe the AMPLITUDE XFR FCTN, try the following exercise:

- a. Set MARKER REL OFF.
- b. Set AMPLITUDE A and AMPLITUDE B OFF.
- c. Set AMPLITUDE XFR FCTN to ON.
- d. Set AMPLITUDE REFERENCE LEVEL for a centered display.
- e. The MARKER functions may be used to provide amplitude and frequency information at a point of interest.
- f. For example, turn the MARKER POSITION control so that the marker is in the vicinity of 5300 Hz. This is the approximate -3 dB point of the transfer function (see Figure 3-14).

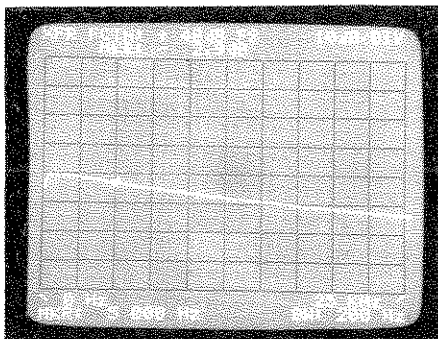

Figure 3-14. Transfer Function for a Two Port Network.

3-73. Phase Measurements. Complete analysis of a waveform requires that phase as well as amplitude be known. Phase data must be relative to a fixed point in time. It is best to use a trigger signal when single channel measurements are made to establish relative phase data. A trigger signal is not required for some dual channel displays since phase data is simply relative between the two channels.

3-74. The phase display uses the central horizontal graticule to indicate zero degrees each division vertically represents 50 degrees. The phase display is dependent on the triggering of the time record, but the phase reference is at the middle of the screen so there is no simple relationship between the phase spectrum and the trigger point. However, the phase reference is at the beginning of the time record if the UNIFORM window is used.

3-75. Since the instrument is already set up to display a transfer function, the phase transfer function of the low pass filter may be observed by setting the following switches:

AMPLITUDE XFR FCTN.....OFF
 PHASE XFR FCTN.....ON
 AMPLITUDE REFERENCE LEVEL.....NORM

3-76. The MARKER controls may be used to indicate the phase reading at a particular frequency of interest. Notice that at low frequencies the relative phase is approximately 0 degrees and at 5300 Hz the phase is approximately 45 degrees (see Figure 3-15).

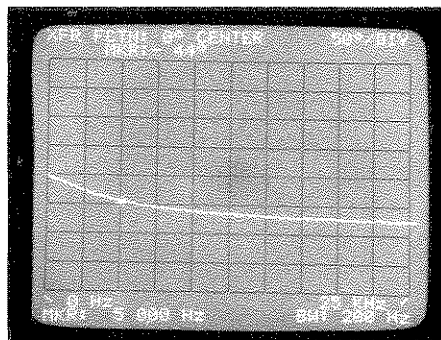

Figure 3-15. Phase Transfer Function of a Low Pass Filter.

3-77. Single channel phase measurements will be illustrated with the use of a function generator. To observe a single channel measurement, try the following exercise:

a. Set the following switches:

```

PHASEXFRFCTN.....OFF
AMPLITUDE A.....ON
PASSBAND SHAPE FLAT TOP.....ON
INPUT CHANNEL A SENSITIVITY.....30 V
INPUT MODE.....A
    
```

b. Set the function generator for a 1 kHz triangle wave output. Disconnect the NOISE SOURCE OUTPUT and connect the output of the function generator to the input of the 3582A via suitable cables. Adjust the output of the function generator and/or the INPUT SENSITIVITY of the 3582A to achieve a full scale display without overloading the 3582A. Now set the 3582A switches as follows:

```

AMPLITUDE A.....OFF
PHASE A.....ON
    
```

3-78. Notice that the phase readings change randomly. This is caused by the TRIGGER LEVEL control being in the FREE RUN position. To stabilize the readings and establish a phase reference, turn the TRIGGER LEVEL control until the desired display is shown. An example display is shown in Figure 3-16.

3-79. There are two important criteria about the phase display that should be noted.

a. Threshold: Except for the phase transfer function, the phase is displayed if the signal is above a certain threshold. If it is below the threshold, 0 degree is displayed and the marker will indicate that it is undefined. This eliminates phase readings resulting from low signal levels (i.e., noise).

b. Slope: There is a phase slope which corresponds to a phase shift across the passband

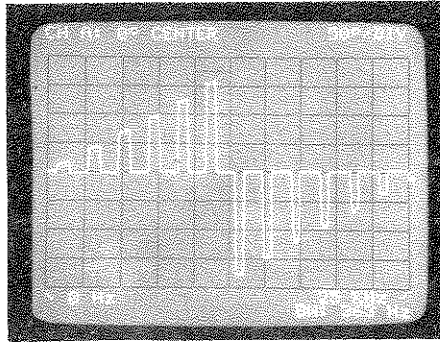

Figure 3-16. Phase Spectrum of a Triangle Wave.

filters. The correct reading is obtained at the center of the sloping segment which is the peak of the amplitude response at that frequency.

3-80. If desired, the MARKER functions and/or the amplitude spectrum may be shown for reference purposes by pressing the appropriate buttons.

3-81. **External Trigger Input.** Another method of establishing a phase reference is through the use of the rear panel TRIGGER INPUT. This is TTL compatible input which is enabled when the TRIGGER switch is set to EXT. Another condition is that the front panel TRIGGER LEVEL control must not be in the FREE RUN position. If your function generator has a TTL pulse output (0 V to 5 V), connect this output to the rear panel TRIGGER INPUT and set the adjacent TRIGGER switch to EXT. Notice that the TRIGGER LEVEL control is now non-functional except in the FREE RUN position. When finished, disconnect the external TRIGGER INPUT and return the TRIGGER switch to INT. It is good to mention at this point that some apparent trigger problems may be due to the inadvertent setting of the rear panel TRIGGER switch. Always verify that this switch is in the proper position for the desired mode of operation of the instrument.

3-82. **The Averaging Functions.** The AVERAGE controls are used to average the spectra displayed on the CRT. Operationally, it replaces the video filtering or display smoothing usually found on spectrum analyzers. The TIME average does offer a unique capability of actually enhancing the signal-to-noise ratio.

3-83. **RMS Average.** The RMS average mode combines a new spectrum with a partial result on a point-by-point basis using an RMS calculation. At any point (m) in the cycle, the amplitude and phase at some frequency (f) are given as:

$$\text{Amplitude: } \sqrt{\frac{1}{m} \sum_{i=1}^m A_i^2}$$

$$\text{Phase: } \frac{1}{m} \sum_{i=1}^m \theta_i$$

This averaging results in smoothing of the noise variations but does not reduce the level of the noise. RMS averaging must be used when making coherence measurements.

3-84. **TIME Average.** The TIME Average mode involves time domain averaging. When a synchronizing trigger is available, successive time records are averaged point-by-point. Time

variations that are coherent with the trigger will average to some value while those that are not coherent will average to zero. This reduces the noise prior to the transformation to the frequency domain. Time averaging is unique in that it does result in an enhancement of the signal-to-noise ratio. It is also by far the fastest averaging mode for wide frequency spans and should be used any time a synchronizing trigger is available.

3-85. *PEAK Mode.* The PEAK mode is not truly an averaging mode, but rather is the result of keeping the maximum input at each frequency point. The phase point retained is the phase of the retained point at each frequency. PEAK averaging is useful for measurements such as monitoring signal drift, etc.

3-86. *Selecting the Number of Averages.* The NUMBER of averages is selectable between 4 and 256 in a binary sequence. The SHIFT key selects whether the lower case black numbers or the upper case blue numbers are active.

3-87. *EXP Mode.* The EXP mode is a continuous averaging process where the new spectrum is weighted $\frac{1}{4}$ and the previous average is weighted $\frac{3}{4}$. This causes the most recent data to be most important while the older data dies out in importance at a decaying exponential rate. The exponential accumulation mode works with the RMS average but in the PEAK mode provides unlimited peak hold. It is most useful when the process under consideration exhibits relatively slow term variations and yet some averaging is still desired. The time constant of the exponential weighting is such that it averages out short term variations, yet follows longer term variations.

3-88. *Running an Averaging Sequence.* In all of the averaging modes except exponential, the instrument stops taking new data when the selected number of averages are completed. When this occurs, the 3582A may appear to be "hung up" when actually it is waiting for further instructions. This is the reason the AVERAGE OFF button is framed. Any time the 3582A appears to be stopped, this button and other framed functions should be checked. When the instrument has taken the selected number of averages, the RESTART button is used to start the next averaging sequence. When the averaging mode is changed, a restart is automatically executed. When the number of averages is changed from one number to a larger number, a restart is also not required; the instrument continues from where it stopped to the new number of averages.

3-89. The following exercise will illustrate the use of the RMS and TIME averaging controls. It requires that the function generator have external modulating capability.

- a. Set the controls of the function generator so that a 5 kHz sine wave can be AM modulated by an external source.
- b. Connect the output of the function generator to the CHANNEL A input of the 3582A.
- c. Using the control information thus far presented, adjust the function generator output and the 3582A controls for a full scale amplitude display using the trigger mode and FLAT TOP PASSBAND.
- d. Select a harmonic of low amplitude and place it in the center of the screen using either SET START or SET CENTER frequency mode (see Figure 3-17).
- e. Connect the NOISE SOURCE OUTPUT of the 3582A to the external modulation input of the function generator.

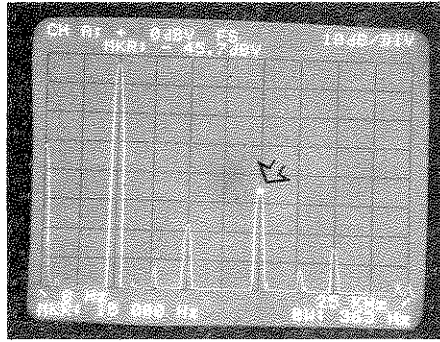

SELECTED HARMONIC

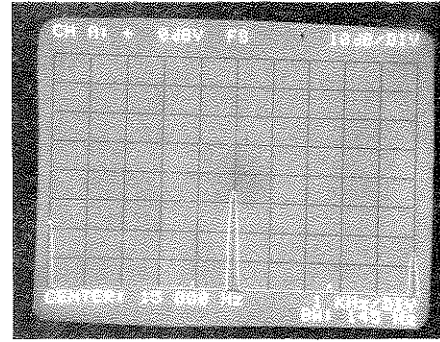

PLACED IN CENTER OF SCREEN

Figure 3-17. Selecting the Correct Harmonic.

f. Adjust the modulation and NOISE SOURCE LEVEL such that the harmonic spectral line is indistinguishable from the noise spectrum (see Figure 3-18). The noise level peaks should be a little lower than the harmonic.

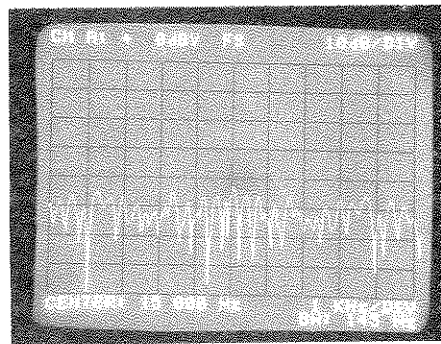
**Figure 3-18. Modulating a Spectral Line with Noise.**

g. Set the AVERAGE controls for a 256 RMS average function. When the average is completed, the spectrum may appear as in Figure 3-19. Notice that the value of the noise has averaged out to an RMS amplitude which is less than its peak value and that the spectra of the harmonic retains the same RMS amplitude throughout the averaging process.

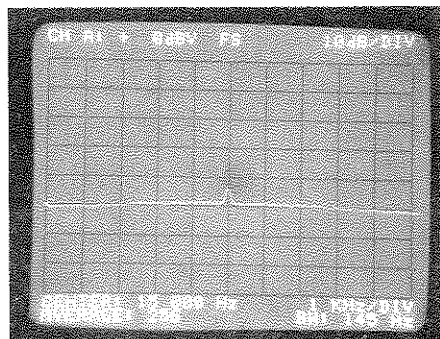
**Figure 3-19. RMS Averaged Signals.**

h. Set the TIME average button to ON and trigger properly. When the average is completed, notice that a signal-to-noise ratio enhancement has taken place (see Figure 3-20).

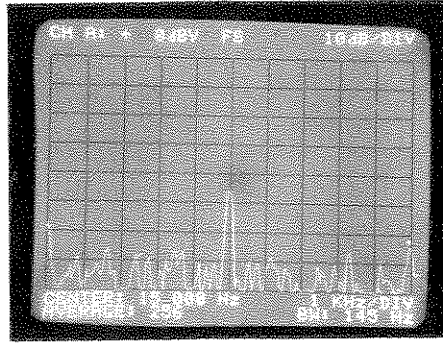

Figure 3-20. TIME Averaged Signals.

This is due to the principle that random noise averages in time to a lower value than a periodic waveform averages in time. Thus, if successive time records (relative to a fixed point in time) were superimposed upon one another, the signal waveform components would coincide while the noise waveform components would not.

i. Disconnect the NOISE SOURCE from the function generator and set the AVERAGE OFF button to OFF.

3-90. The following exercise illustrates the PEAK average mode and requires the function generator to have FM modulating capabilities.

- a. Adjust the function generator for a 10 kHz sine wave modulated by a 1 Hz sine wave.
- b. Adjust the controls of the 3582A for a center frequency of 10 kHz and a SPAN of 2.5 kHz.
- c. The sine wave spectral line should be oscillating in frequency as indicated in Figure 3-21.

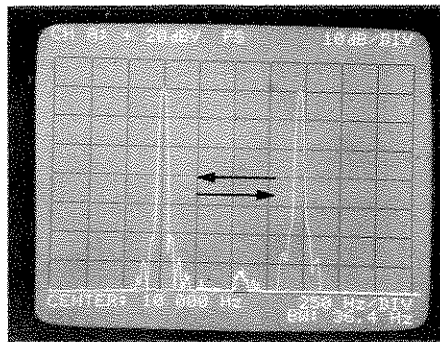

Figure 3-21. Oscillating Frequency Spectrum.

d. Press the PEAK average button to ON. At the end of 256 averages, the FM passband should appear as in Figure 3-22. This shape describes the maximum amplitude of the spectral line as it sweeps between maximum and minimum frequency.

3-91. Time Functions. The TIME display buttons supersede the other display controls. Only one time display can be selected at a time and all other displays are suspended. The TIME display is active only as long as the pushbutton is held in. It is important to note that the

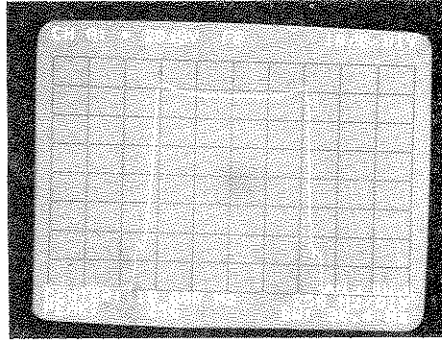

Figure 3-22. Spectrum of an FM Passband.

TIME display is used mainly for setting input sensitivities and for determining when a time record is complete; it does not replace an oscilloscope. The information displayed consists of alternate samples of the input time record in the baseband modes. In the band analysis modes, the time record may not be representative of the input signal since it is mixed with the Digital Local Oscillator before being stored.

3-92. Coherence. The coherence display is activated when the instrument is in the two channel RMS average mode and the COHER button is set to the ON position. The most common use of this display is as a check on the validity of a transfer function measurement. The coherence function is also a measure of the proportion of power in an output signal caused by an input signal. A coherence value of 1.0 would indicate that the cause/effect relationship is ideal and the transfer function ratio at that frequency is valid. Figure 3-23 shows two signals derived from the same source and their coherence relationship.

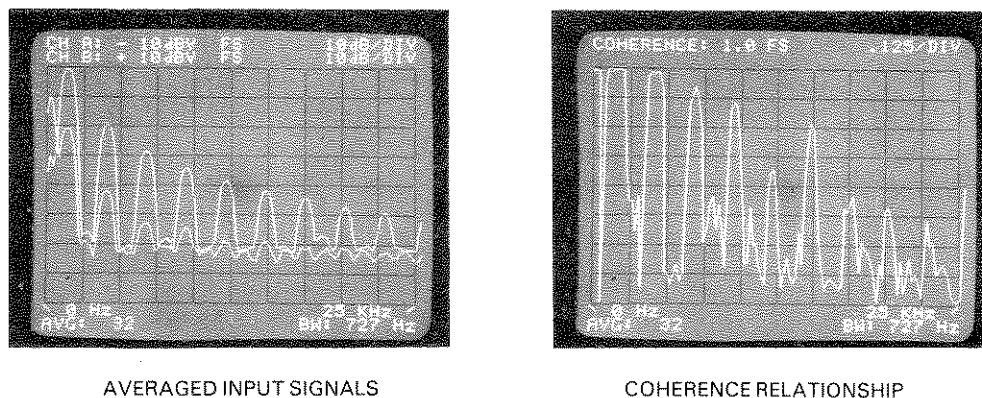

Figure 3-23. The Coherence Relationship Between Two Signals.

Notice that the coherence function shows unreliable data in the higher frequencies. This is largely due to the signal-to-noise ratio of the smaller signal which becomes less as the frequency increases. Also note that when the signal-to-noise ratio of either signal is low, the coherence is also low.

3-93. To observe the TIME and COHER functions, try the following exercise.

- a. Connect the function generator output to the 3582A's channels A and B input via suitable cables and connectors.

- b. Set the function generator for a 2 kHz triangle wave output.
- c. Set the 3582A for normal dual channel amplitude measurement (in case of difficulty, see Turn-On Procedure).
- d. Set SCALE to 10 dB/DIV and the INPUT MODE to BOTH.
- e. With CHANNEL A and CHANNEL B INPUT SENSITIVITY controls set to +30 dBV, adjust the function generator for a half scale (approximately -10 dBV) display.
- f. To observe the channel A TIME function, depress the TIME A button and hold it in while varying the channel A INPUT SENSITIVITY. This will show the effect of the INPUT SENSITIVITY switch on the TIME amplitude. Set the AMPLITUDE A and B buttons to OFF.
- g. To observe the coherence function, set the COHER button to ON, RMS AVERAGE button to ON, and AVERAGE NUMBER 64 to ON. The RMS averaging sequence should begin immediately with the coherence display becoming valid at the end of the sequence.
- h. Experiment with the coherence function by varying the INPUT SENSITIVITY controls, pressing RESTART, and noting the result on the display when the averaging sequence is completed.
- i. When finished, press the AVERAGE OFF button and set the COHER button to OFF.

3-94. Storing Traces.

3-95. The graphics portion of a single trace being displayed may be stored in TRACE 1 and/or TRACE 2, but either or both may be recalled using the dual channel mode of operation. The MARKER functions do not work on the recalled traces and the stored traces are not affected by any front panel operations except POWER OFF.

3-96. The following exercise illustrates the use of the trace STORE and RECALL functions.

- a. Connect the NOISE SOURCE OUTPUT to the channel A INPUT.
- b. Set the controls of the 3582A for a dual channel amplitude measurement. (In case of difficulty, see the Turn-On Procedure.)
- c. Set the SCALE 10 dB/DIV to ON, the INPUT MODE switch to BOTH, and AMPLITUDE A to ON.
- d. Set the INPUT SENSITIVITY switches as follows:

CHANNEL A..... +20 dBV
 CHANNEL B..... CAL

- e. With channel A only being displayed, press the TRACE 1 STORE button.
- f. Change the AMPLITUDE buttons to display channel B only and press the TRACE 2 STORE button.

g. Keeping in mind that only two traces may be displayed at one time, experiment with the TRACE RECALL buttons, INPUT MODE switch, and the DISPLAY AMPLITUDE buttons to get different combinations of recalled traces and amplitude functions.

3-97. Conclusion.

3-98. Storing Traces marks the end of the Familiarization Exercise. It must be reiterated that only the most fundamental concepts were covered and that expertise acquired through continued use of the instrument will lead to discoveries of many applications for measuring spectra using the variety of unique capabilities of the 3582A.

NOTE

See Application Notes in Appendix D for additional information.

3-99. OPERATING ON SIGNAL DATA.

3-100. Introduction.

3-101. The following information is presented in order to maximize the user's efficiency in the operation of the 3582A. The two main functions involving the use of the instrument controls are:

- a. Acquiring a time record.
- b. Operating on stored time data.

3-102. Acquiring a Time Record.

3-103. Because the time record is stored in digital form, the 3582A is a versatile instrument for doing transient analysis. The irregular nature of transient signals, however, dictate that the time record of the captured event must remain unaltered until all applicable analysis is completed. The 3582A has many functions, therefore, great care must be exercised to avoid destroying a time record through the inadvertent setting of a control. To acquire a time record, the following conditions should prevail:

- a. INPUT, TRIGGER, and FREQUENCY controls should be set prior to the initiation of a trigger.
- b. If more than one time record is needed and the AVERAGE functions are used, the PASSBAND SHAPE must be established prior to the initiation of the trigger signals.

Once a time record is established, several operations may be carried out on the data.

3-104. Operating on Stored Time Data.

3-105. Data may be displayed without destroying the time record under the following conditions:

- a. The display of transformed time data may be made in any of the formats indicated by the switches in the DISPLAY group. Note, however, that some DISPLAY functions may require certain setups in the INPUT and TRIGGER switch groups.

- b. Once a trace is displayed, the MARKER functions may be used to obtain information at a particular point of interest.
- c. Traces may also be stored, recalled, or plotted by an external plotting instrument.
- d. The PASSBAND SHAPE may be changed but only if the AVERAGE functions are not used.

NOTE

Pressing the RESET button will clear the time record, but it will not clear traces which are stored using the TRACE 1 and/or TRACE 2 storage functions.

3-106. Using the Recorder Output.

3-107. An X-Y analog recorder (such as the -hp- Model 7004B) may be used to plot the graphics portion of the display. Three controls on the 3582A front panel allow the processor to operate the X-Y analog outputs and the PEN LIFT control output located on the rear panel.

3-108. To initiate a plot, the following steps should be taken:

- a. All 3582A and recorder interface lines should be connected and both instruments turned on.
- b. Next press the LL↓← (RESET) button in order to set the lower left-hand corner minimum scale pen position using the recorder offsets.
- c. The UR →↑ button on the 3582A may be pressed in order to set the upper right-hand corner full scale pen position using the recorder gain.
- d. When the desired spectrum is present on the display and you are ready to plot, press the PLOT button. The 3582A will automatically control the pen lift line throughout the entire plot and return the recorder pen to its initial position when the plot is finished or terminated. If desired, choose another trace and plot again (see Figure 3-24).
- e. To terminate a plot, press the LL↓← (RESET) button to cause the recorder pen to return to its initial position.

NOTE

No other operations on the 3582A may be initiated during a plotting sequence except RESET or HP-IB inputs.

3-109. USING PROBES.

3-110. The -hp- Model 10001A Voltage Divider Probe is recommended for use with the 3582A. The probe has a tip impedance of 10 megohms shunted by 10 pF and a 10:1 division ratio. The probe is especially valuable for use in analyzing high impedance circuits. Note, however, that most high impedance probes such as the -hp- 10001A have capacitive compen-

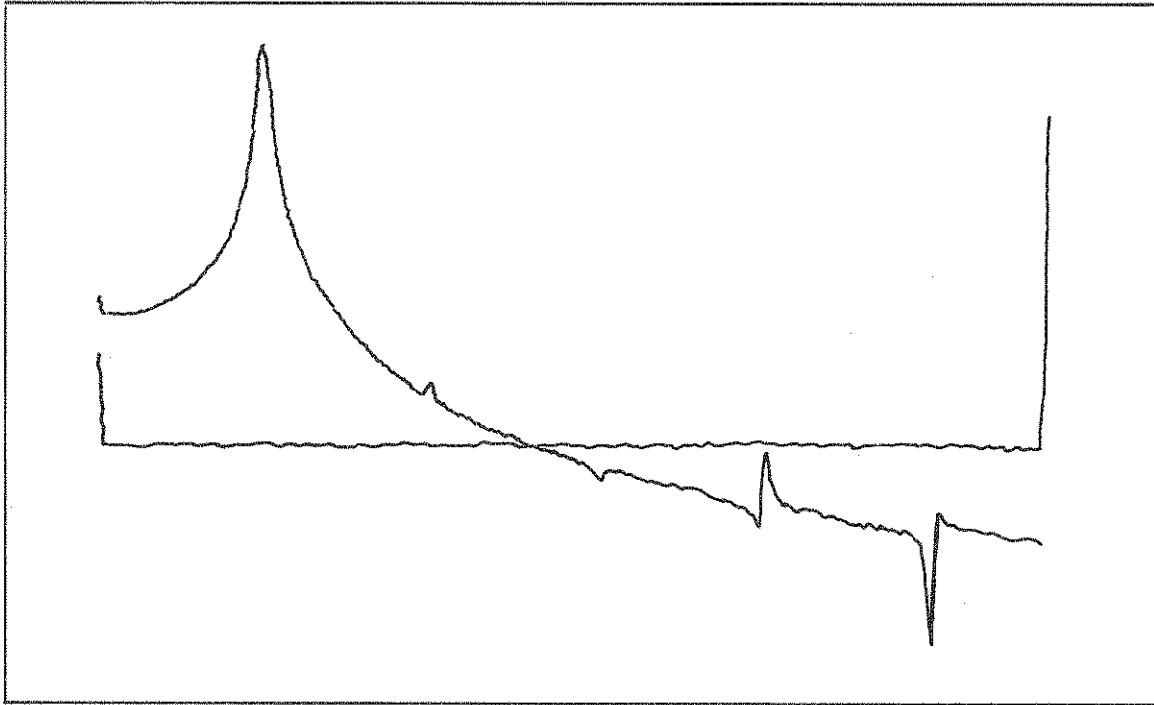

Figure 3-24. A Two Trace Plot.

sating adjustments which effect their frequency response. Before using the -hp- 10001A probe in a measuring application, the probe should be compensated to match the input impedance of the 3582A. Once the probe is properly adjusted, it should not require further attention. It is a good practice, however, to perform periodic verification tests to assure that optimum adjustment is maintained.

3-111. Probes Are Delicate.

3-112. If you have ever tried to use a probe that does not work because it has been abused, you will appreciate the excerpt from -hp- *Bench Briefs* given in Figure 3-25.

3-113. Probe Compensation Procedure.

3-114. The Probe Compensation Procedure uses the Amplitude Transfer Function measuring mode and the PERIODIC NOISE SOURCE OUTPUT of the 3582A.

- a. Turn on the 3582A and/or set the switches as indicated in the Turn-On Procedure.
- b. Set the CHANNEL A SENSITIVITY for 3 V.
- c. Set the INPUT MODE switch to BOTH.
- d. Set the CHANNEL B SENSITIVITY for .3 V.
- e. Connect the NOISE SOURCE OUTPUT to channel A INPUT via suitable cable and connectors.
- f. Connect the cable from the probe to channel B using a BNC adapter (-hp- Part No. 1251-2277).

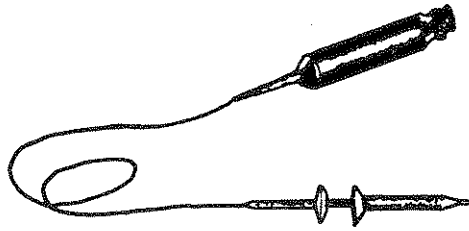

Although oscilloscope probes are as common as pocket screwdrivers, they need to be handled with much more care than the normal screwdriver. Probes are often dropped on the floor, stepped on, rolled over with carts or even used as tow ropes to pull systems around on carts.

Probes are designed to be as rugged as possible, but many times they are abused. It turns out that a high-frequency passive probe is a fairly sophisticated piece of electronic equipment, even if it doesn't sound or look exciting. Electrically, there is a complex termination and compensation network at the base of the probe. The probe tip has the divider resistor (usually about 9 megohms) and another compensating capacitor. One of the toughest things to design and build well is the probe cable. To keep the input capacitance at the probe tip as low as possible, the cable must be very low capacitance. To accomplish this, a very small center conductor must be used. The smaller the center conductor, the lower the capacitance, but also, the easier it is to break the center conductor. The typical diameter of a probe cable center conductor is 4 mils (about the size of a hair!). The point is that a probe should be handled with care, just as any precision measuring tool should be.

Figure 3-25. About Scope Probes.

- g. Attach the probe tip to the signal input on channel A and the ground lead to channel A ground.
- h. Place the DISPLAY AMPLITUDE XFR FCTN to the ON position. Adjust the AMPLITUDE REFERENCE LEVEL for a centered display.
- i. Adjust the probe so the response is flat over the entire frequency range (see Figure 3-26).

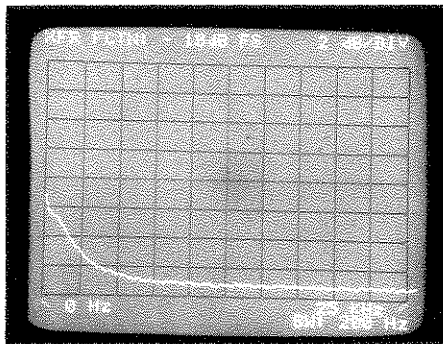

UNCOMPENSATED

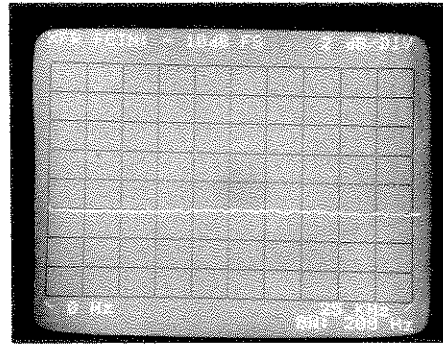

PROPERLY COMPENSATED

Figure 3-26. Probe Compensation.

3-115. FRONT PANEL SCREWDRIVER ADJUSTMENTS.

3-116. Front panel screwdriver adjustments are provided for periodic fine tuning of the instrument. Under most normal operating conditions, there is no need to change the setting

of these adjustments, however, it is a good practice to verify that the instrument is tuned for optimum accuracy before a critical measurement is made.

3-117. ASTIG (Astigmatism) Adjustment.

3-118. The ASTIG adjustment is an analog control which works in combination with the FOCUS control to provide well defined traces and characters on the display. The adjustment of this control may be made anytime the instrument is turned on and there is a display on the CRT. It is often necessary to alternate adjusting the ASTIG control and the FOCUS control to provide a sharp, clear display.

3-119. BAL (Balance) Adjustments.

3-120. The BAL adjustment effects the dc offset of the Input Amplifiers and balances offsets even though ac COUPLING is selected. The BAL adjustment is usually made on the most sensitive input range of the instrument, however, when making a critical measurement, the adjustment should be made on the particular range in use.

3-121. The following procedure is given for adjusting the BAL control on the most sensitive input range, but the same principal procedure applies for adjusting the BAL control on any of the INPUT SENSITIVITY ranges in channel A or channel B.

- a. Set the switches on the 3582A as indicated in the Turn-On Procedure.
- b. Set the DISPLAY AMPLITUDE to A.
- c. Set the SCALE to LINEAR.
- d. Connect a short across the input terminals of channel A.
- e. Set the channel A COUPLING to DC(---).
- f. Set the CHANNEL A SENSITIVITY to 3 mV.
- g. Adjust the BAL control for a minimum amplitude at the 0 Hz frequency point (see Figure 3-27).
- h. Rotate the AMPLITUDE REFERENCE LEVEL control fully clockwise and repeat Step g. This completes the BAL adjustment.
- i. A quicker but less accurate method is to press the TIME function button for the appropriate channel and adjust the time trace for zero volts by centering it on the middle horizontal graticule.

3-122. IN CASE OF TROUBLE.

3-123. Introduction.

3-124. The 3582A, because of its high degree of flexibility, has many operating modes requiring some fundamental knowledge of the operating controls. Under some circumstances, the instrument may appear to be operating incorrectly, when all that is really

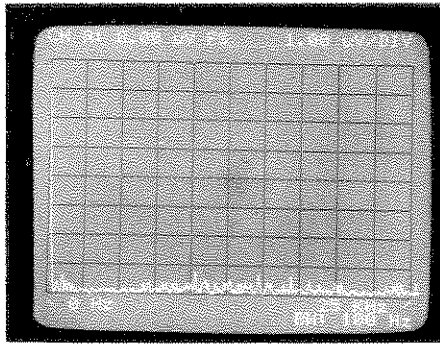

INCORRECT ADJUSTMENT

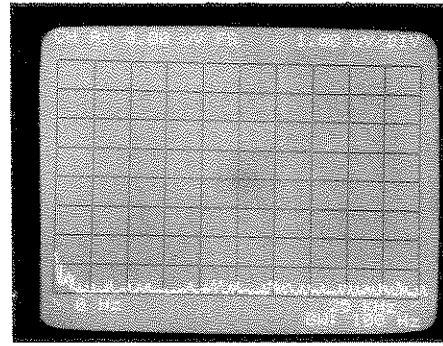

PROPER ADJUSTMENT

Figure 3-27. Adjusting the BAL Control.

needed is correct operator interpretation and input. The following information will aid the operator in interpreting situations which may arise during measurement sequences. It is intended only as a supplement to the information presented in the Familiarization Exercise. The Familiarization Exercise should be read (and performed) before any (other) operation of the instrument is attempted.

3-125. "Hung Up" (Instrument does not appear to respond).

3-126. If the instrument does not appear to respond to front panel controls, check the following list of possibilities:

- a. Instrument under REMOTE Local Lockout.
- b. No trigger signal available:
 1. Trigger REPETITIVE is OFF.
 2. No INPUT on channel A.
 3. Incorrect TRIGGER LEVEL setting.
 4. Rear panel switch set to EXT without an input connected.
 5. Improper EXT input level.
- c. An average has been completed and the instrument is awaiting further averaging instructions. (Suggestion: turn AVERAGE to OFF.)
- d. A Plotting operation has been initiated and the instrument is awaiting completion of the plot. Note that the display will remain active during this time.

3-127. Overload.

3-128. Data displayed under OVERLOAD conditions may involve the following peculiarities:

- a. Overload occurs at 100% of full scale input and may produce spurious responses in spectral display data.
- b. The TIME display is shown as alternate time record points; therefore it is possible to have an overload indication which does not appear in the TIME record display.

c. Signals are clipped at full scale and as a result, displayed spectra may be misrepresented in amplitude.

d. To avoid a possible overload when using TIME AVERAGE, be sure that input signals are at least 2 dB below full scale.

3-129. Unrelated Spectral Displays.

3-130. The 3582A may display spectra which are unrelated to the input signal under the following circumstances:

a. If using either SET START or SET CENTER, several spectral lines may appear above 26 kHz. These spectra are derived from the switching power supplies and from an analog to digital exercising signal.

b. If the PERIODIC NOISE SOURCE is used in combination with either the SET START or SET CENTER frequency modes, the spectral data within one SPAN width of 0 Hz may be inaccurate due to local oscillator translated noise aliasing around 0 Hz and adding to the desired spectral data. To avoid this problem, use the 0 START frequency mode.

c. Unrelated spectral displays may be caused by data analyzed under OVERLOAD conditions.

d. Stray signals present in both input channels may result in an abnormally high COHERENCE level even though there is no cause and effect relationship, merely the presence of a common signal. (Suggestion: use well shielded input cables.)

3-131. Noise Source Output.

3-132. The 3582A has two types of noise sources available. There are measurement situations where the use and choice of a noise source may be critical in achieving correct results. The Noise Source Output has the following peculiarities:

a. The PERIODIC noise source will cause uneven or noisy transfer function measurements on non-linear systems. (Suggestion: Use the RANDOM source and AVERAGING.)

b. Use an external source resistor when driving low impedance filters. For example, use a 50 ohm external series resistor when driving a 50 ohm filter. This is necessary because of the low output impedance (< 2 ohms) of the Noise Source Output.

3-133. SIMPLIFICATION OF DISCRETE DATA ANALYSIS.

3-134. Introduction.

3-135. The following description is presented in order to provide the user with a feel for what is taking place in the 3582A as data is converted from the time domain to the frequency domain. While this is entirely a mathematical process, the main vehicle for explanation will be graphical with many math operations assumed for simplification.

3-136. Time Domain Considerations.

3-137. The sampling function is carried out by hardware while the conversion to the frequency domain is handled by firmware. Sampling is accomplished in the Analog-to-Digital Converter at a 102.4 kHz rate and involves the multiplication of the normalized input waveform by an impulse train of unity amplitude. This results in the waveform being broken down into a series of amplitude pulses separated by the period of the sampling impulses (see Figure 3-28).

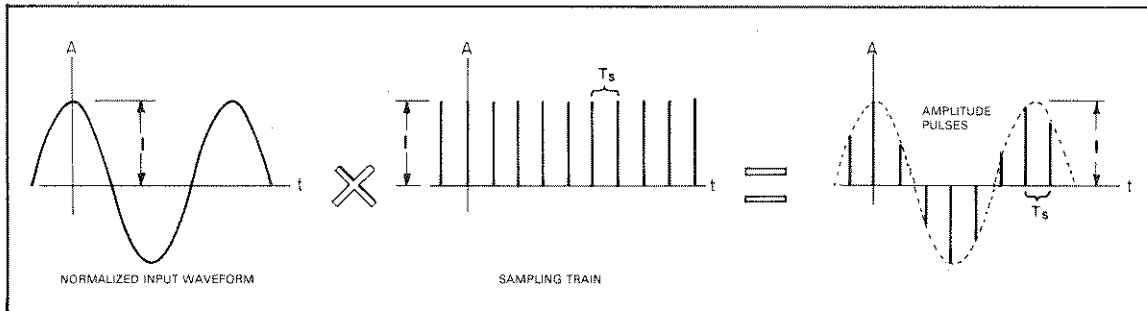

Figure 3-28. Sampling an Input Waveform.

3-138. Because of limited memory and other processing requirements, sampled data cannot be taken indefinitely and therefore must be restricted to a period of time called a window. A window in this particular sense is defined as a square pulse of unity amplitude which, when the sampled data is multiplied by the window, confines it to a particular time interval (see Figure 3-29).

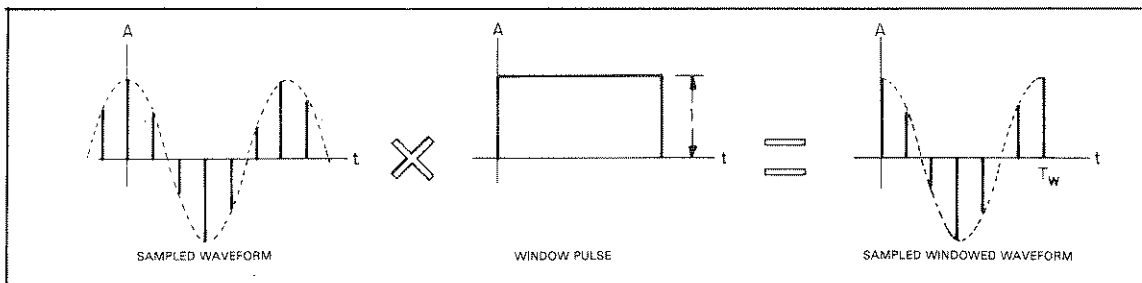

Figure 3-29. Windowing a Sampled Waveform.

3-139. Frequency Domain Considerations.

3-140. So far, three waveforms and two processes have been given in the time domain. Each waveform and process has an equivalent representation in the frequency domain which is carried through by Fourier Analysis. For example, assume the input is a cosine waveform which has a discrete line spectrum in the frequency domain. Its representation in the frequency domain is indicated in Figure 3-30.

3-141. Notice that as a result of the transform, half of the energy is represented in the negative frequency region of the spectrum. This situation is eliminated by scaling the amplitude data by a factor of two before it is displayed.

3-142. The sampling train is composed of impulses of theoretically zero width. An impulse train transforms into a discrete line spectrum with lines spaced at $1/T_s$ intervals. Its representation in the frequency domain is indicated in Figure 3-31.

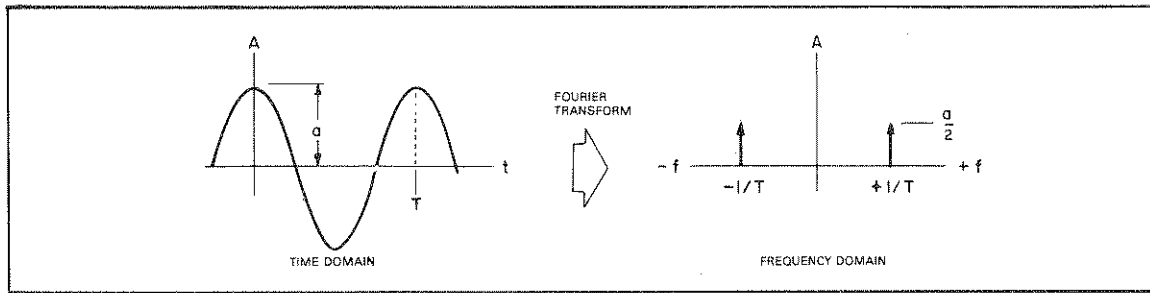

Figure 3-30. Frequency Representation of a Cosine Wave.

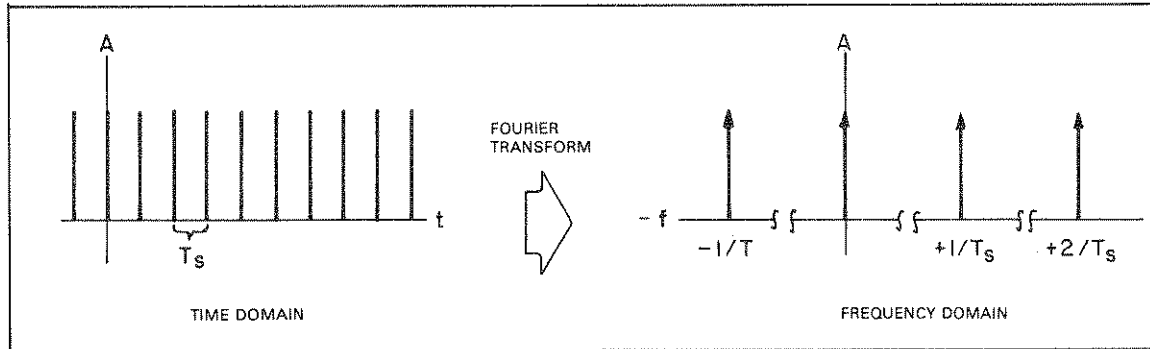

Figure 3-31. Frequency Representation of an Impulse Train.

3-143. The square pulse has a unique frequency domain representation which is not discrete but a continuous function and is composed of all frequencies. This function is represented by the formula $Y = \text{SIN } X/X$ (see Figure 3-32).

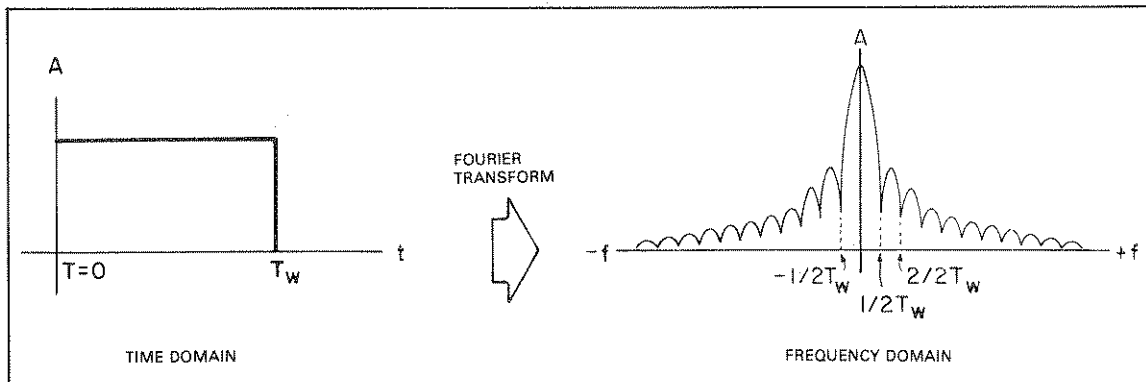

Figure 3-32. Frequency Representation of a Square Pulse.

3-144. In the time domain, different waveforms were multiplied resulting in a new modified waveform, i.e., the sampled windowed cosine wave. This multiplication process is represented in the frequency domain by another process called convolution. In a mathematical context, the operation involves the use of the Convolution Integral, sometimes known by its other name, the Superposition Integral. The convolution of the cosine spectrum with a sampling spectrum is shown in Figure 3-33.

3-145. Notice that the impulse spectrum has been combined into the new cosine and impulse spectrum. Another convolution operation is necessary involving the sampled cosine spectrum and the window spectrum (see Figure 3-34).

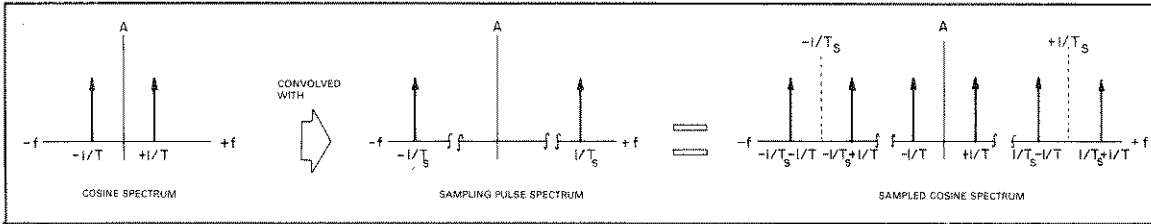

Figure 3-33. Convolution of the Cosine Spectrum with the Sampling Pulse Spectrum.

3-146. Although there appear to be three sets of SIN X/X shapes, each set is replicated at intervals of $1/T_s$ (sampling frequency) out to infinity in both positive and negative frequency domains. A seeming paradox is that all the information needed by the 3582A is contained in one-half of any one set or one SIN X/X shape and its relationship to the origin or zero Hz mark. The other sets cannot be forgotten and may impair desirable data due to a characteristic of sampling systems called aliasing.

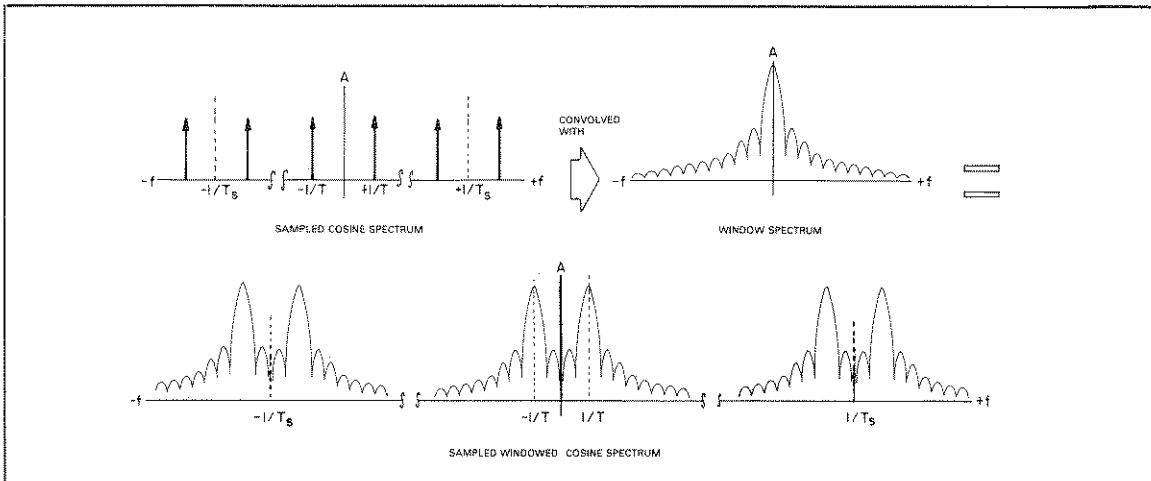

Figure 3-34. Convolution of a Sampled Cosine Spectrum with a Window Spectrum.

3-147. Aliasing.

3-148. Consider what would happen if the frequency of the cosine wave were to increase. Each SIN X/X shape in a pair would separate (see Figure 3-35).

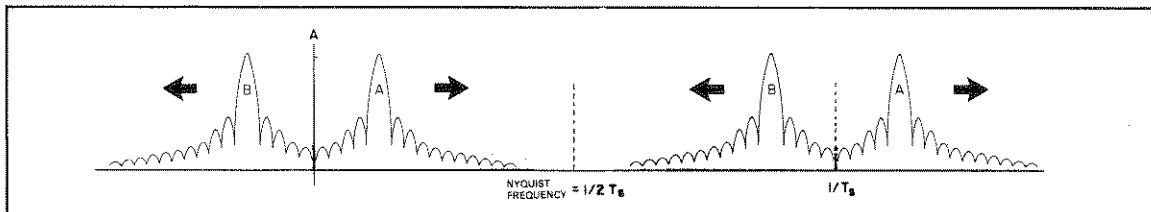

Figure 3-35. Increasing the Frequency of a Cosine Wave.

Remembering that the sampling frequency ($1/T_s$) is constant, it can be visualized that as the cosine wave continues to increase in frequency, the SIN X/X shapes will meet at a point half-way between the sampling frequency and the origin. This point is called the Nyquist Frequency and defines the maximum frequency of a sampled waveform. Any further increase in the waveform frequency above the Nyquist point will result in an overlapping of spectrums and contamination of data in the desirable region of the spectrum under analysis. This is called aliasing (see Figure 3-36).

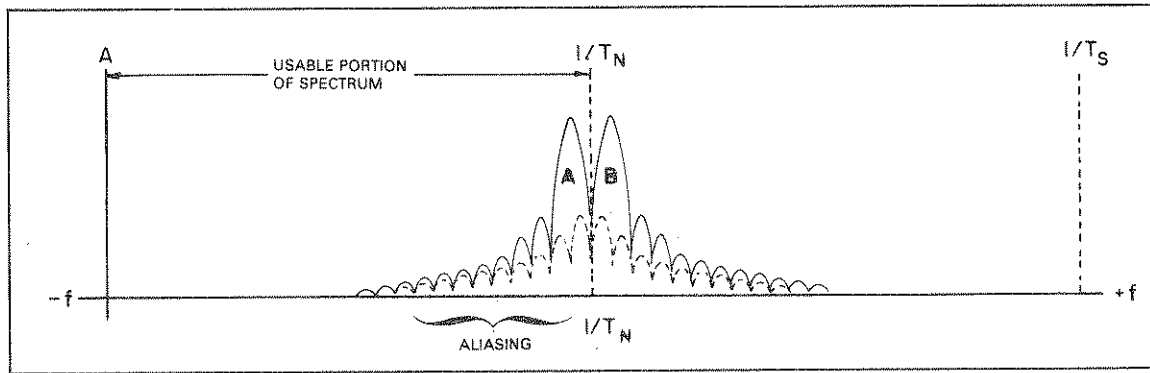

Figure 3-36. Aliasing.

3-149. Aliasing may be minimized by increasing the sampling frequency or filtering the input waveform so that frequency components above the Nyquist point are reduced to acceptable levels. The 3582A does the latter of the two and has an antialiasing filter in the input section which is flat to 25 kHz and then rolls off to approximately -80 dB at 70 kHz. Since the sampling frequency is 102.4 kHz and the Nyquist Frequency is at 50 kHz, data within the dynamic range of the instrument should be free from alias contamination (see Figure 3-37).

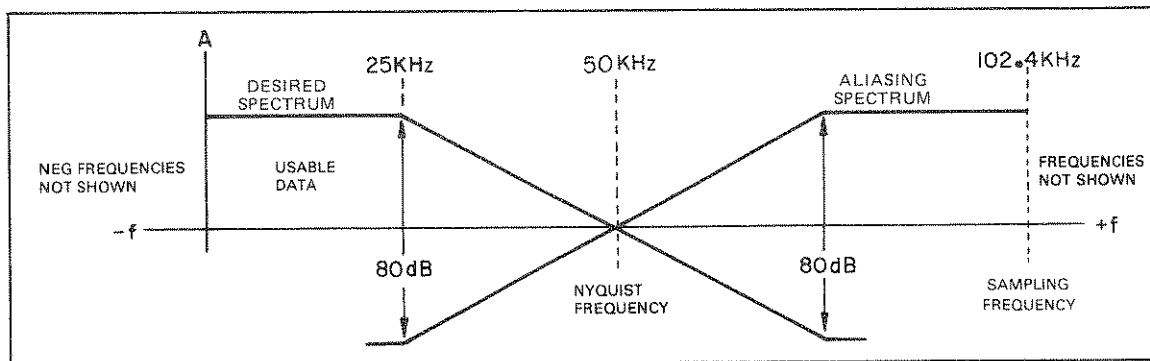

Figure 3-37. 3582A Antialiasing Filter.

3-150. Data in Memory.

3-151. Refer again to the SIN X/X shape (see Figure 3-38).

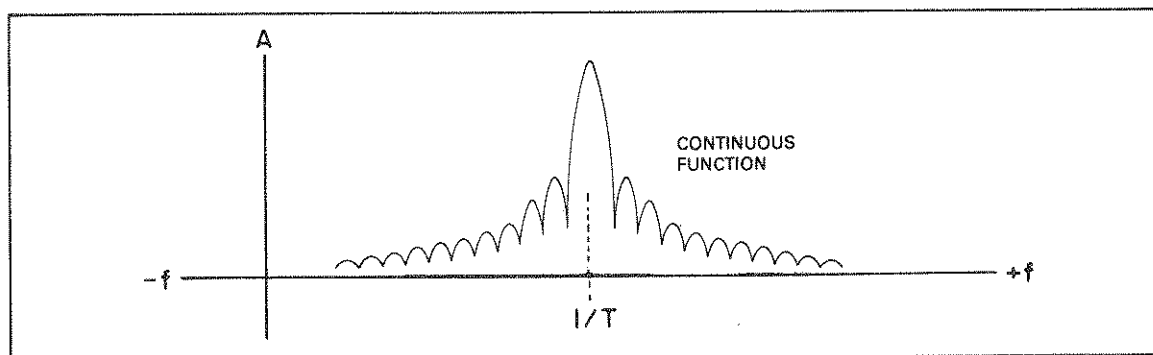

Figure 3-38. The Continuous Function.

3-152. What has been presented to this point is a graphical analogy of the continuous function resulting from the Fourier Transform of a cosine wave. But the 3582A uses an

implementation of the Discrete Fourier Transform called the Fast Fourier Transform. The key here is the word discrete. Instead of the transform being evaluated for all frequencies, the discrete transform is evaluated at selected frequency intervals. Therefore, the discrete transform is an approximation of the continuous transform and the resemblance to the latter depends upon the number of frequency evaluation points. How many points are needed? Naturally, the more points evaluated, the more defined the function becomes. The 3582A has 256 display points on single trace and 128 display points on double trace stored in memory. These points are derived from a 1024 point or 512 point time record (the result of sampling) which also resides in memory. These combination of points are a compromise among filter design, memory allocation, and display information. A way of visualizing the spectrum points in memory is to think of the continuous function masked by a slotted overlay (see Figure 3-39).

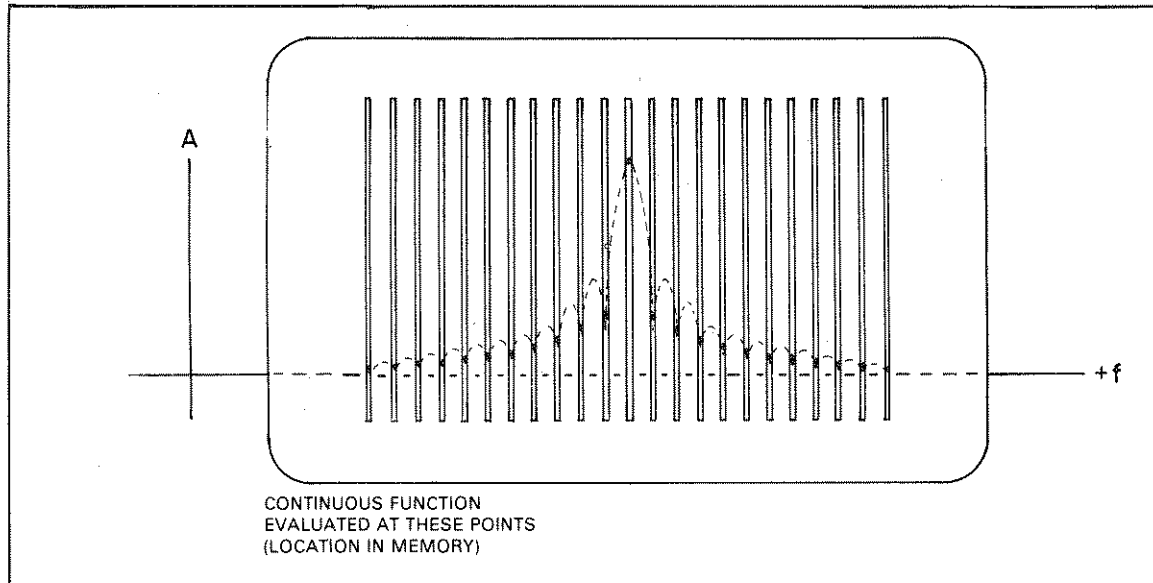

Figure 3-39. Spectrum Points in Memory.

3-153. Interpreting the Display.

3-154. It is now easy to understand that each location in memory is a frequency point (commonly referred to as a frequency bin) and that the digital word in that location (bin) represents the amplitude and phase at that point. The Display Section contains the hardware and firmware which allows the display to be shown as the data points connected by straight line segments (see Figure 3-40).

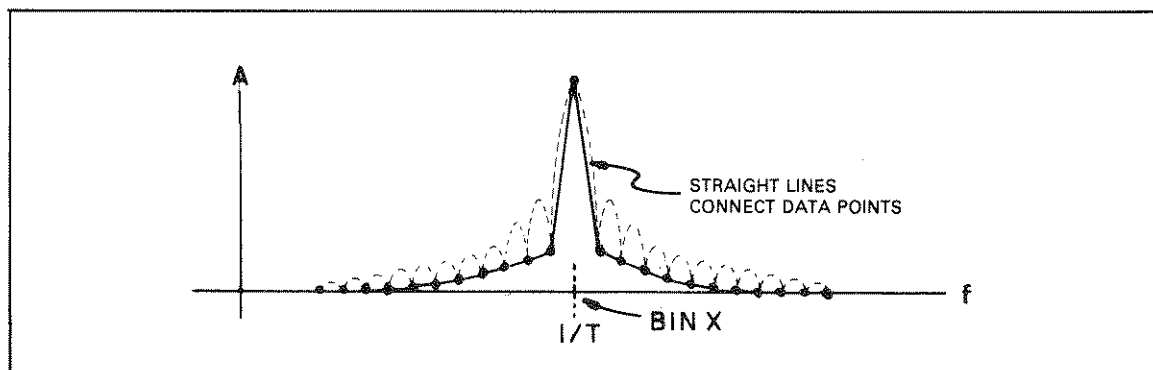

Figure 3-40. Memory Data Points Displayed on CRT.

3-155. Notice that many of the spectrum points occur in the valleys (nulls) of the $\text{SIN } X/X$ shape. Remembering that the frequency bins are fixed relative to the frequency scale, what would happen if the cosine wave input were to change slightly in frequency? Spectrum points will now be determined at other parts of the $\text{SIN } X/X$ shape (see Figure 3-41). This distorted spectrum is the result of leakage.

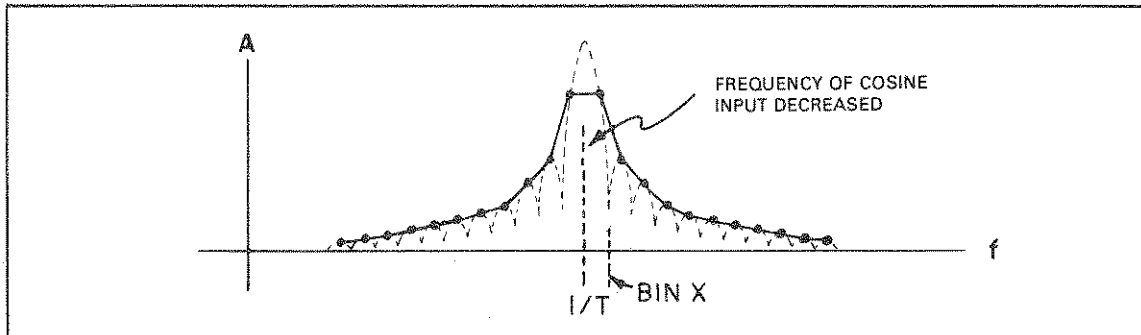

Figure 3-41. Leakage of Energy.

3-156. Leakage.

3-157. A property of the $\text{SIN } X/X$ shape is that the nulls (valleys) line up with the bin frequencies whenever the center frequency of the waveshape under examination occurs at a bin frequency. Thus, changes result only when the frequency of the input is varied and the worst case occurs when the center frequency of the signal being analyzed is shifted between two adjacent bin frequencies. Because energy is related to amplitude, the undesirable changes in amplitude between adjacent bins is called leakage. The energy is said to have leaked from one bin to another. One method for reducing leakage is to modify the window function which operates on the time record.

3-158. Windowing.

3-159. As previously described, windowing involved the limiting of the number of samples of the input waveform to a particular interval of time. Therefore, windowing may be thought of as performing some operation on data as it passes through. Additional time domain windows may be added in series to manipulate frequency domain data through the convolution process (multiplication of data in the time domain).

3-160. The $\text{SIN } X/X$ shape in the frequency domain was the result of time domain sampling with no further windowing operations applied. The frequency domain function produced inaccuracies when evaluated in a discrete manner. These inaccuracies were primarily due to the excessive relative amplitude of the sidelobes of the function (see Figure 3-42).

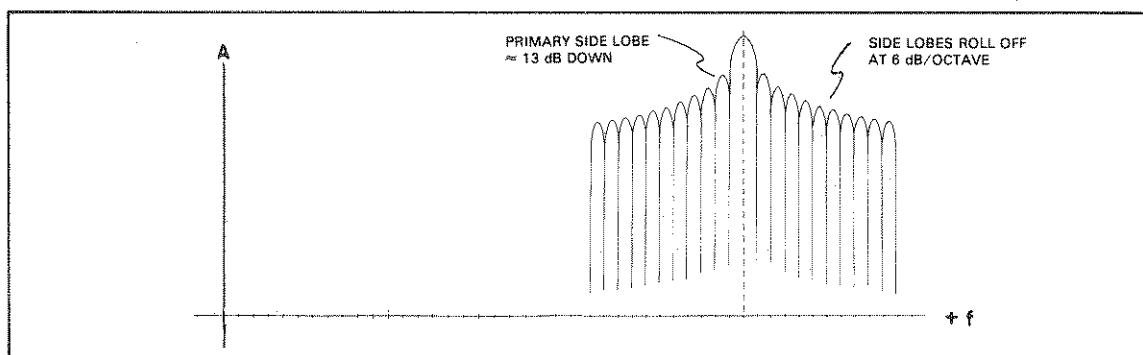

Figure 3-42. Sidelobes of Transformed Rectangular Window.

3-161. Notice that the primary sidelobes are only 13 dB down and that successive sidelobes roll off at 6 dB/octave. The sidelobe amplitude may be reduced through the use of additional windowing operations, but this occurs only at the expense of increased bandwidth. This sidelobe-bandwidth tradeoff translates into an amplitude accuracy versus frequency resolution tradeoff when the choice of passbands needs to be considered.

3-162. The additional windowing functions are accomplished when time domain data is shifted from the accumulated time record buffer in memory to another buffer in memory where the Fast Fourier Transform is performed (see Figure 3-43).

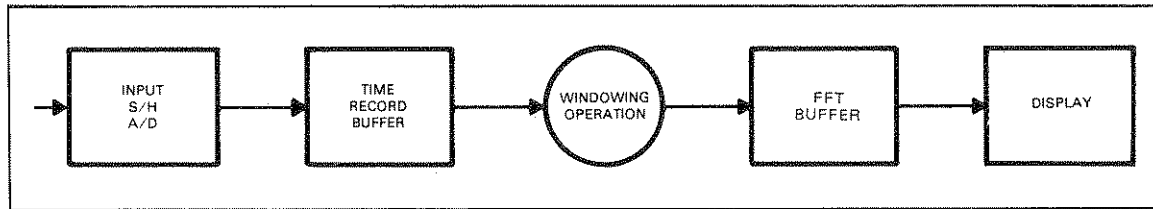

Figure 3-43. Data Flow.

3-163. Window Functions.

3-164. The window functions, including additional notes are presented as follows:

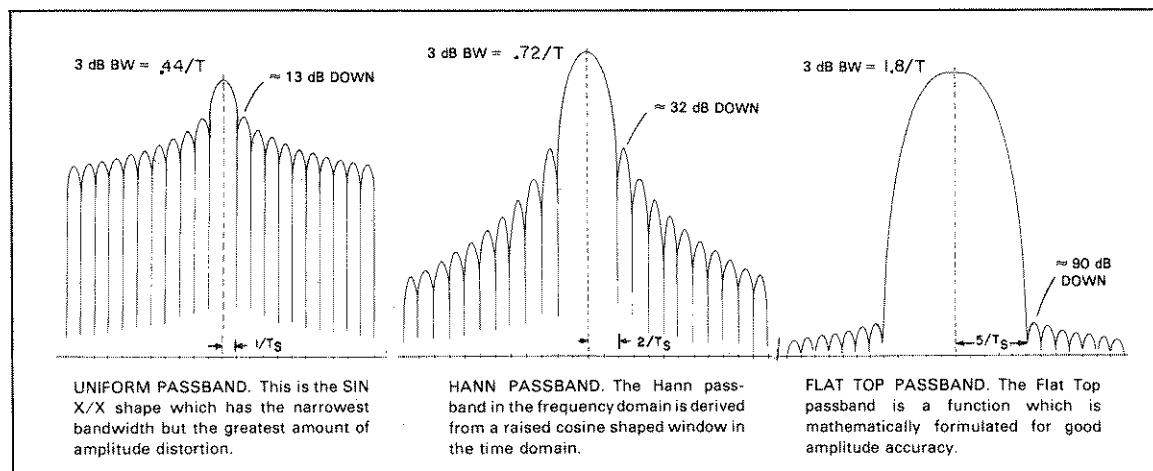

Figure 3-44. Window Functions.

NOTE

The Hann window, commonly referred to as the Hanning window, was discovered by Julius von Hann. Hanning refers to the operation of applying a Hann window.

SECTION III PART II REMOTE OPERATION

3-165. REMOTE OPERATION.

NOTE

The 3582A may be remotely controlled in much the same manner as it is controlled manually. Therefore, it is recommended that the manual operation of the instrument be learned before remote operation is attempted.

3-166. INTRODUCTION.

3-167. The following information concerning remote operation of the 3582A via the Hewlett-Packard Interface Bus (HP-IB) will be supplemented with examples using the -hp- 9825A Calculator and -hp- 1000 computer (controllers) with equivalent examples incorporating the Meta Message concept. For a condensed description of the HP-IB, see Appendix B. For a condensed description of the Meta Message concept, see Appendix C.

NOTE

HP-IB is Hewlett-Packard's implementation of IEEE Std. 488-1975, "Standard Digital Interface for Programmable Instrumentation".

3-168. While the -hp- 9825A and -hp- 1000 are specific controllers, fully capable of implementing all the HP-IB functions used with the 3582A, the Meta Message equivalent may be referenced to by any controller which is HP-IB compatible.

NOTE

Not all HP-IB compatible controllers may possess the sophistication necessary to utilize the complete remote capabilities of the 3582A.

3-169. 3582A REMOTE FUNCTIONS.

3-170. General Description.

3-171. In remote operation, the 3582A has even greater flexibility than in manual operation. The following functions describe how the 3582A may be controlled through the HP-IB:

Remote Front-Panel Programming

In addition to the normal front panel switch controls, the operation of the 3582A can be controlled by remote commands sent on the HP-IB.

Instrument Data Output

Display data, alphanumerics, switch settings and other useful data can be output from the instrument for the purpose of making plots, additional processing, etc.

Instrument Data Input

Time record data obtained by external means can be input to the instrument for analysis. Also, any of the instrument data output may be reentered into the instrument at a later time.

Instrument Signal Processing Control and Status

Additional special HP-IB commands allow limited control of the signal processing. An 8 bit status word is available to indicate various states of the signal processing.

3-172. REMOTE FRONT PANEL PROGRAMMING.

3-173. The Command List specifies all of the functions which may be activated by the 3582A via the HP-IB. Note that many of the functions are the remote equivalent of setting a front panel switch manually and may be executed in similar sequences. For example, the arm command (AR) would not be given until all other applicable functions are set for a measurement operation. The Command List is given in Appendix A.

3-174. The HP-IB status light "REMOTE", located at the lower left of the front panel, indicates whether the instrument is currently operating under local (front panel switches) or remote control. Remote operation is accomplished only via commands sent on the HP-IB.

3-175. When the instrument is in local, the operation is determined solely by the front panel settings. At the time that the instrument is programmed to remote, the operation remains exactly the same as it was in local. Additional commands sent on the HP-IB can change the mode of operation. Returning to local, either by pushing the LOCAL button or by an HP-IB command, causes the instrument to return to front panel switch control.

3-176. Syntax.

3-177. The Command List (actually sent as DATA) is divided into groups of related operations. Each command in a group is divided into a function and a setting (some groups do not have settings). If the function is a front panel switch, the letters will correspond to the underlined letters of the name of that switch on the front panel. The setting indicates a switch position. A zero setting will indicate that the switch is out (OFF) and numbers greater than zero indicate that the switch is in (ON) or set at some other position (rotary switches and slide switches). On rotary and slide switches, a one (1) will indicate a counterclockwise or left most position (COUPLING switches excepted, a one indicates ac).

3-178. **Adjust Frequency.** For Adjust Frequency (AD 0-24999), the setting is a number which corresponds to the CENTER or START frequency in the band analysis modes.

3-179. **Marker Position.** The marker position setting corresponds to a position on the display. For single trace modes of operation, the marker may be programmed to one of 256 horizontal positions. For dual trace operation, the marker may be programmed to one of 128 horizontal positions on the selected trace.

3-180. Delimiters.

3-181. Delimiters are not needed, but if desired, commas, spaces, upper or lower case alphanumerics can be used.

NOTE

The last character needs to be followed by a CRLF, space, or a comma. For example, the 9825A automatically sends this information if the wrt statement is used. If the cmd statement is used, these additional characters must be supplied. The PRINT statement on the -hp- 1000 automatically defaults to CRLF if these characters are forgotten. Spaces following characters will not effect the messages sent, except for the write alphanumerics (WTA) command which requires the output string of characters to have a fixed number of characters (32) and may consist of spaces and/or alphanumeric characters.

	-hp- 9825A	-hp- 1000
Example:	wrt711, "prs, ad442, ac1"	10 PRINT#11; "prs, ad442, ac1"
	wrt711, "PRSAD442AC1"	10 PRINT #11; "PRSAD422AC1"

3-182. SPECIAL FRONT PANEL COMMANDS.

3-183. Special commands are useful when it is desirable to set the front panel controls for a particular mode of operation. Special sequences are useful when data is being transferred between the 3582A and a controller.

3-184. Using Preset.

3-185. The preset (PRS) command places the 3582A front panel controls in a mode which is equivalent to that in the Turn-On Procedure. If the 3582A instrument appears to be "hung up" due to an inadvertant programming error, sending the PRS command will often return the instrument to an operating status. Furthermore, it is a good programming practice to "initialize" the front panel controls of the 3582A using the PRS command before entering an extensive programming sequence. See the Command List in Appendix A for the PRS switch settings.

3-186. Setting the Marker.

3-187. The marker position command (MP) combined with a marker position number (0-255 or 0-127) sets the marker horizontal position on the display. The marker position may be determined by the following equations:

$$\text{MARKER POSITION} = \frac{250 \text{ (or } 125^*)}{\text{SPAN}} \times (f_m - f_s)$$

Where: f_m = Desired marker frequency
 f_s = START FREQUENCY or $\left(\text{CENTER FREQUENCY} - \left(\frac{\text{SPAN}}{2} \right) \right)$

***NOTE**

The marker has 128 positions for each trace in dual mode.

3-188. Note that on larger spans and dual trace operation, the marker position (derived from the equation) will not be an integer for some frequencies. In this case, round the marker position to the nearest integer number.

3-189. INSTRUMENT DATA OUTPUT.

3-190. The listing commands are used to read control or display data from the 3582A. The general form for initiating a list command requires that the list command be given by the controller which sets the 3582A in a "talk" mode. The 3582A will then output data, as specified by the list command, to the controller which must then be programmed to the "listen" mode.

3-191. Listing Control Settings.

3-192. The position of some front panel control settings, in decimal or exponential format, may be read by the controller through the following list commands:

Command	Description
LAD	List frequency adjust value NNNNN.NN CRLF
LMK	List marker amplitude and frequency \pm NNNNE \pm NN; NNNNN.NNN CRLF
LSP	List span (Hz) NNNNN CRLF
LAS	List channel A sensitivity
LBS	List channel B sensitivity
LXS	List Transfer Function sensitivity

} \pm N.NNE \pm NN CRLF

3-193. Notice that all of the list commands above, except LMK, require one variable in which to store the data in the controller. The LMK instruction requires two variables in which to store data, and both must be available when the LMK command is given. (See the HP-IB section of your controller manual for information on how to read from the HP-IB into multiple variables.) The sensitivities obtained by the LAS, LBS, and LXS commands are the same as those indicated on the display and are the total of the SENSITIVITY switch setting and the AMPLITUDE REFERENCE LEVEL switch setting. The units are either volts or dBV as determined by the LOG/LINEAR switches.

3-194. Program Examples.

<pre>-hp- 9825A 0: "program to demo LAD comman d": 1: fxd 1;wrt 711,"LAD" 2: red 711,A; prt A;dsp "FREQ =" ,A 3: lcl 711;end #6446</pre>	<p>META Equivalent</p> <p>REMOTE DATA: LAD</p> <p>DATA: NNNNN.NN CRLF</p> <p>LOCAL</p>
----------------------------------------------------------------------------------------------------------------------------------------------------	--------------------------------------------------------------------------------------------

-HP - 1000-

META Equivalent

```

-----
10 CALL RMOTE(7)
20 PRINT #7; "LAD"
30 READ #7;A
40 PRINT "FREQUENCY ADJUST "A" HZ"
50 CALL GTL(7)
60 END

```

```

REMOTE
DATA: LAD
DATA: NNNNN.NN CRLF
LOCAL

```

-hp- 9825A

META Equivalent

```

0: "program to
demo LMK comman
d":wrt 711;"LMK
";red 711;A;B
1: flt 2;prt A;
B;dsp "A=";A;
"B=";B
2: lcl 711;end
*17489

```

```

REMOTE
DATA: LMK
DATA: ±NNNNE±NN,+NNNNN.NNN CRLF
LOCAL

```

-HP- 1000

META Equivalent

```

-----
10 CALL RMOTE(7)
20 PRINT #7;"LMK"
30 READ #7;B,C
40 PRINT "MARKER AMPLITUDE ="B" DBV"
45 PRINT "MARKER FREQUENCY ="C" HZ"
50 CALL GTL(7)
60 END

```

```

REMOTE
DATA: LMK
DATA: ±N.NNN E±NN,NNNNN.NNN CRLF
LOCAL

```

-hp- 9825A

META Equivalent

```

0: "program to
demo LSP comman
d":
1: fxd 1;wrt
711;"LSP"
2: red 711;A;
prt A;dsp "SPAN
=";A
3: lcl 711;end
*323

```

```

REMOTE
DATA: LSP
DATA: NNNNN CRLF
LOCAL

```

-HP - 1000-

META Equivalent

```

-----
10 CALL RMOTE(7)
20 PRINT #7; "LSP"
30 READ #7;A
40 PRINT "SPAN "A" HZ"
50 CALL GTL(7)
60 END

```

```

REMOTE
DATA: LSP
DATA: NNNNN CRLF

```

LOCAL

-hp- 9825A

META Equivalent

```

0: "program to
demo LAS comman
d":
1: flt 2;wrt
711,"LAS"
2: red 711;A;
prt A;dsp "ASEN
S=";A
3: lcl 711;end
*29531

```

```

REMOTE
DATA: LAS
DATA: ±N.NNE±NN CRLF

```

LOCAL

-HP - 1000-

META Equivalent

```

-----
10 CALL RMOTE(7)
20 PRINT #7; "LAS"
30 READ #7;A
40 PRINT "CH. A SENSIVITY (DBV/V):"A
50 CALL GTL(7)
60 END

```

```

REMOTE
DATA: LAS
DATA: ±N.NNE±NN CRLF

```

LOCAL

3-195. Listing Display Data. The display graphics or the display alphanumeric may be listed using the following instructions:

Command	Description
LDS	List display (128, 256, or 512 points in corresponding units) each point $\pm N.NNE \pm NN$ separated by commas; CRLF
LAN	List alphanumeric (128 ASCII characters, CRLF); representing the four 32 character lines)

3-196. The LDS instruction causes the 3582A to output data from the display in three different quantities. The number of points which are outputted depends upon the particular mode of operation the instrument is in when the LDS command is received (see Table 3-2).

Table 3-2. LDS Points Returned.

No. of Points	Mode of Operation
128	Single trace in dual channel mode
256	1. Single trace in single channel mode 2. Dual trace in dual channel mode (128 points for channel A followed by 128 points for channel B) 3. Single time trace in dual channel mode
512	Single trace time in single channel mode

3-197. The points are outputted in corresponding units. That is, the SCALE and SENSITIVITY will determine the type of units and the relative magnitude. However, the magnitude of the time points are determined by the SENSITIVITY setting alone. Each group of ASCII coded characters is separated by commas with the CRLF sent after the last point.

NOTE

It is important to note that some controllers may not accept a comma as a delimiter and therefore may require special programming steps in order to receive and retain the number representing each point sent.

3-198. Note that if the display is listed when the instrument is in the UNCAL (uncalibrated) mode, the units which are output will be different than when the instrument is in the CAL mode (see Table 3-3).

Table 3-3. Output Units.

Function	CAL	UNCAL
Amplitude	dBV (log) Volts (lin)	0 to 1
Time	-1 to +1	0 to 1
Phase	-200 to +200	0 to 1
Transfer Function	dB	dB

3-199. Program Example.

```

-hp- 9825A                                META Equivalent

0: "program to
  demo LDS comman
  d":
1: fmt 1,f4.0,                                REMOTE
  2x,e10.2;wrt                                DATA: LDS
  711,"LDS"
2: red 711
3: for I=0 to 9
4: red 731,A;                                DATA: Each point ±N.NNE±NN
  wrt 16.1,I,A;                                separated by commas;
5: next I                                       CRLF sent last
6: spc 2;lcl
  711;end
*23532                                         LOCAL
    
```

3-200. The LAN (list alphanumerics) instruction causes the 3582A to output 128 ASCII coded characters which represent the four alphanumeric display lines. Note that some symbols such as $\sqrt{\quad}$ (square root) do not have an ASCII equivalent and may require conversion to another code form. Table 3-4 gives the displayed character and the ASCII equivalent which is sent or received over the HP-IB.

Table 3-4. Display-ASCII Equivalents.

LISTEN				TALK			LISTEN				TALK		
OCT	DEC	CHAR SENT	CHAR DISP	CHAR RETN	OCT	DEC	OCT	DEC	CHAR SENT	CHAR DISP	CHAR RETN	OCT	DEC
41	33	!	!	!	41	33	104	68	D	D	D	104	68
42	34	"	u	u	165	117	105	69	E	E	E	105	69
43	35	#	d	d	144	100	106	70	F	F	F	106	70
44	36	\$	n	a	155	109	107	71	G	G	G	107	71
45	37	%	z	z	172	122	110	72	H	H	H	110	72
46	38	&	x	x	170	120	111	73	I	I	I	111	73
50	40	<	/	/	57	47	112	74	J	J	J	112	74
51	41	>	\	r	134	92	113	75	K	K	K	113	75
52	42	*	o	*	52	42	114	76	L	L	L	114	76
53	43	+	+	+	53	43	115	77	M	M	M	115	77
55	45	-	-	-	55	45	116	78	N	N	N	116	78
56	46	.	.	.	56	46	117	79	O	O	O	117	79
57	47	/	/	/	57	47	120	80	P	P	P	120	80
60	48	0	0	0	60	48	121	81	Q	Q	Q	121	81
61	49	1	1	1	61	49	122	82	R	R	R	122	82
62	50	2	2	2	62	50	123	83	S	S	S	123	83
63	51	3	3	3	63	51	124	84	T	T	T	124	84
64	52	4	4	4	64	52	125	85	U	U	U	125	85
65	53	5	5	5	65	53	126	86	V	V	V	126	86
66	54	6	6	6	66	54	127	87	W	W	W	127	87
67	55	7	7	7	67	55	130	88	X	X	X	130	88
70	56	8	8	8	70	56	131	89	Y	Y	Y	131	89
71	57	9	9	9	71	57	132	90	Z	Z	Z	132	90
72	58	:	:	:	72	58	134	92	r	\	r	134	92
74	60	<	<	<	74	60	144	100	d	d	d	144	100
76	62	>	r	r	162	114	155	109	a	a	a	155	109
77	63	?	?	?	77	63	162	114	r	r	r	162	114
101	65	A	A	A	101	65	165	117	u	u	u	165	117
102	66	B	B	B	102	66	170	120	x	x	x	170	120
103	67	C	C	C	103	67	172	122	z	z	z	172	122

3-201. Program Example.

-hp- 9825A

META Equivalent

```
0: "program to
demo LAN comman
d":
1: dim A#[130];
fxd 0
2: wrt 711,"LAN"
3: red 711,A#
4: wrt 16,A#[1,
32]
5: wrt 16,A#[33,
64]
6: wrt 16,A#[65,
96]
7: wrt 16,A#[97,
128]
```

REMOTE
DATA: LAN
DATA: 128 ASCII characters, CRLF

```

8: wrt 0,A#[1,
  32];stp
9: wrt 0,A#[33,
  64];stp
10: wrt 0,A#[65,
  96];stp
11: wrt 0,A#[97,
  128];stp
12: lcl 711;end
*5323

```

LOCAL

```

-HP - 1000-
-----

```

META Equivalent

```

1 DIM A$(140)
2 FOR I = 1 TO 130
3 A$(I) = "X"
4 NEXT I
10 CALL RMOTE(7)
20 PRINT #7;"LAN"
30 READ #7;A$

40 PRINT A$(1,32)
50 PRINT
60 PRINT A$(33,64)
70 PRINT
80 PRINT A$(65,96)
90 PRINT
100PRINT A$(97,128)
110CALL GTL(7)
120END

```

REMOTE
DATA: LAN
DATA: 128 ASCII CHARACTERS,
CRLF

LOCAL

3-202. INSTRUMENT DATA INPUT.

3-203. Writing Alphanumeric Messages.

3-204. Alphanumeric messages may be written into any of the four alphanumeric lines on the display through the use of the following instruction:

WTA 1-4, 32 ASCII Characters

select line 1,2,3, or 4 Use blanks to fill up remaining spaces to total 32.

The first part of the instruction (WTA) should be followed immediately by a line number and a comma. The next 32 characters are reserved for the text of the message. For example, to write "A COSINE SPECTRUM" on line 1 of the display, the command and message would appear as follows (Δ means space):

"WTA1,ΔΔΔΔΔΔΔΔΔΔCOSINEΔSPECTRUMΔΔΔΔΔΔΔΔ"

NOTE

The text of the message must have at least 32 characters or the 3582A will not display the message and will appear to be "hung up" while waiting for the completion of the message.

3-205. Program Example.

```

-hp- 9825A                                META Equivalent

0: "program to
   demo WTA comman
   d":
1: dim B#[37]
2: "WTA1,"->B#[1,
   5];dsp "Write
   a 32 character
   message";wait
   5000;ent B#[6,
   37]
3: prt B#[6,37];
   wrt 711,B#
4: lcl 711;end
*23868
    
```

REMOTE
 DATA: WTA1, 32 ASCII characters
 LOCAL

3-206. WORKING WITH MEMORY.

3-207. The RAM (Random Access Memory) contents are completely accessible via the HP-IB. Data in memory is stored in a binary format consisting of 16 bit words. But information is transferred over the HP-IB in 8 bit bytes, therefore, two bytes are required to transmit or receive memory word.

3-208. The Binary Format.

3-209. In order to work with memory data directly, it is important that the binary format of words be understood. The words themselves indicate a magnitude for numerics or a particular code for alphanumeric. There are no units indicated in a numeric word and the word is simply a 2's complement binary number with an equivalent decimal range of from - 32768 to + 32767 (see Figure 3-45).

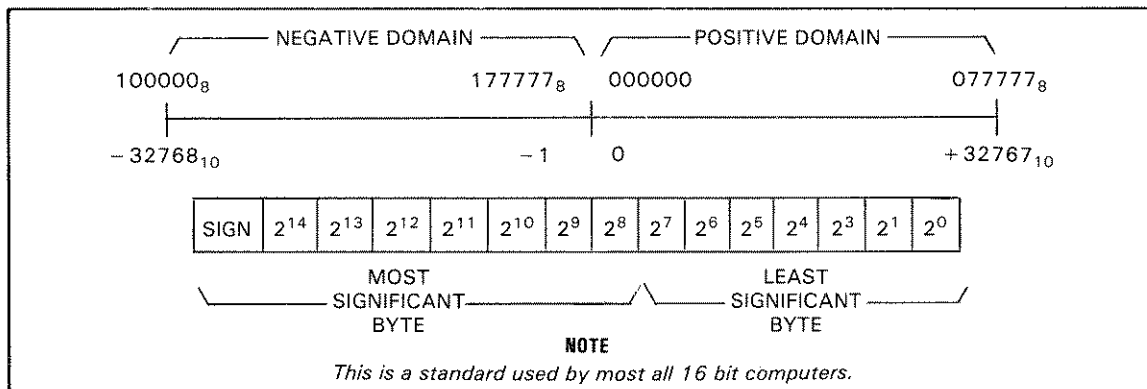

Figure 3-45. Words in Memory.

3-210. In the display section of memory, numerics and alphanumerics are mixed together and require a decoding procedure if they are to be interpreted by a controller program as binary data. This will generally not be necessary since the List Display commands perform the decoding operations and transmit the words in ASCII format.

3-211. When binary data is transmitted over the bus between the controller and the 3582A, the most significant byte of a 16 bit word is sent first followed by the least significant byte.

3-212. Memory Instructions.

3-213. There are two instructions for working with binary memory data. These commands are primarily for the advanced user who wishes to input his own time record or display or to do special processing:

<u>Command</u>	<u>Description</u>
LFM,M,N	List from memory
WTM,M,N	Write to memory

Where: M = Start address (octal)

N = Number of words to be transferred (decimal)

Data is in 2N 8 bit bytes, most significant byte first

3-214. These memory instructions are transmitted via the HP-IB in ASCII format. The controller must be programmed to take the appropriate action directly after the instruction is sent with no intervening messages. Each instruction requires that the memory location (in octal) be specified. For example, if a time record is to be entered into the 3582A for processing, the instruction would appear as follows:

WTM,70000,1024

NOTE

The 3582A starts accepting or sending binary data after the LF character is sent. The CRLF is automatically sent by the 9825A if the wrt command is used and by the -hp- 1000 when the PRINT statement is used. For other commands and controllers, check the order and type of characters used as delimiters. When the LFM or WTM instruction is used, a CR or LF is not sent by the 3582A after the binary string, nor is it looked for after a binary string is received from the controller.

After the instruction is given, the controller may send the data as a character string or as individual bytes. (Character strings may be composed of 8 bit bytes and are one of the faster methods for transferring data between the controller and the 3582A.) See EXAMPLE FLOWCHARTS AND PROGRAMS.

3-215. Memory Locations.

3-216. The principal memory locations of interest are given as follows:

<u>Description</u>	<u>Start Address (M, octal)</u>	<u>Number of Words (N, decimal)</u>	<u>Binary Format</u>
Time Record	70000	1024	Numeric
Display	74000	512	Alphanumeric
Front Panel Switches	77454	5	Numeric
Stored Trace 2	75400	256	Numeric

3-217. INSTRUMENT SIGNAL PROCESSING CONTROL AND STATUS.

3-218. Service Request.

3-219. Service Request (SRQ) is set only as a result of syntax errors caused by improper HP-IB commands. It is cleared by a DEVICE CLEAR or cleared as the result of a SERIAL POLL. When cleared, the five bit status byte returned will always consist of zeros.

3-220. Status Word.

3-221. The status word may be used to determine what operational state the 3582A is in. The eight bit status word contains the following information:

Bit	Value	Meaning
0	1	Diagnostic on screen. Indicates current switch setting is invalid. Set and cleared by 3582A.
1	2	Arm light is on. Set and cleared by 3582A to agree with arm light on front panel.
2*	4	A overload. Set by 3582A when <ol style="list-style-type: none"> 1. Time record is moved to FFT area or time record is complete 2. and hardware overload has occurred 3. and A or BOTH INPUT MODE
3*	8	B overload. Same as A.
4*	16	Time record complete. Set when 1024 new time points have been taken since last record complete. Set when time complete data has been FFT'D and displayed. Use LST1 to check this flag! It depends on internal flags which are cleared by LST0.
6*	64	Average complete.
7*	128	X-Y plot complete. if two traces are plotted, it is set after the final trace.

NOTE

The Status Word is not the same as the HP-IB STATUS BYTE. The STATUS BYTE returned as the result of a serial poll will be zeros since the only reason for an SRQ from the 3582A is incorrect HP-IB commands.

3-222. The two commands for obtaining a status word are:

<u>Command</u>	<u>Description</u>
LST1	Reads status word
LST0	Reads status word and then resets*

As with many other HP-IB commands, the controller first gives the command and then reads the returning byte into a variable for decoding. The LST0 command resets the starred bits after they are read so that new information may be entered on the next machine cycle.

3-223. Program Example.

<pre> -hp- 9825A 0: "program to demo LST commo d": 1: moctifxd 0: wrt 711,"LST1" 2: dsp rdb(711): lcl 711:end *9201 </pre>	<p>META Equivalent</p> <p>REMOTE DATA: LST1 DATA: Binary 8 bit word LOCAL</p>
-------------------------------------------------------------------------------------------------------------------------------------	-------------------------------------------------------------------------------------------

3-224. Processor Control Commands.

3-225. There are two processor control commands which can be used to improve data transfer rates when large blocks of data are transmitted.

<u>Command</u>	<u>Description</u>
HLT	Unconditional halt at next HP-IB branch point
RUN	Unconditional run

Without the use of these commands, the processor handles the HP-IB in an interrupt mode of operation. When the HLT command is given, the processor is stopped which allows practically direct memory access without unnecessary time delay. After the data is transferred, the processor may be returned to normal operation by giving the RUN command. However, no momentary buttons are processed when the processor is in the HLT mode.

3-226. EXAMPLE FLOWCHARTS AND PROGRAMS.

3-227. Loading a Time Record Into Memory.

3-228. The following flowchart presents the fundamental steps needed to load a time record into memory in the baseband 0-25 kHz mode. The time record should consist of 1024 data points with each point being a 16 bit 2's complement number (other magnitude ranges will require scaling). The example flowchart (see Figure 3-46) includes scaling for a function which has a range between +1 and -1 and also conversion of the scaled number to an integer.

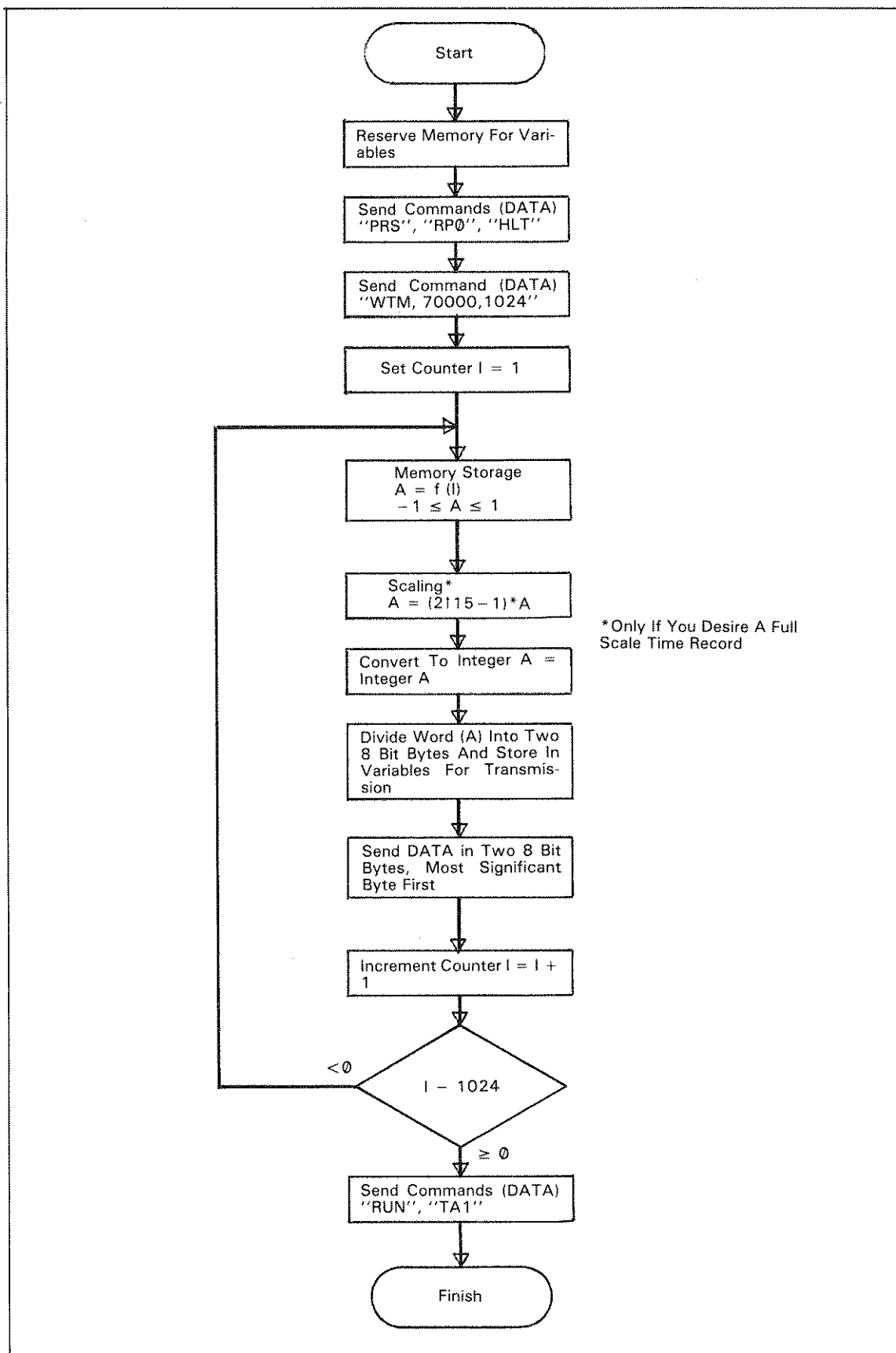

Figure 3-46. Storing a Time Record in Memory.

3-229. Program Example: Writing to Memory.

```

-hp- 9825A
                                META Equivalent

0: "program to
  demo WTM comman
  d":
                                REMOTE
1: rd#wrt 711,
  "TA1"
                                DATA: TA1
2: mdecldim A[10
  24]
3: for I=1 to
  1024
4: 20000*cos(2π*
  (I-1)/256)→A[I]
5: next I
6: fmt 1,"WTM,
  70000,1024"
7: wrt 711.1
                                DATA: WTM,70000,1024
8: beep
9: for I=1 to
  1024
10: wtb 731,shf(
  A[I],8)
                                DATA: Most significant 8 bit byte
11: wtb 731,band
  (255,A[I])
                                DATA: Least significant 8 bit byte
12: next I
13: beep
14: end
*9460

```

3-230. Reading Binary Data From Memory.

3-231. The following flowchart presents the fundamental steps needed to read data from memory. A very useful function, derived from this operation, is the storage of data for long periods of time. Remember that if the 3582A is turned off, all data in RAM is lost. As an example, switch settings, time records, or the entire display may be stored in the controller and then later written back into the 3582A memory (using a technique similar to entering a time record but without the need for scaling since the data itself is merely being stored and not operated on). The example flowchart (see Figure 3-47) includes scaling* but this step may be skipped if the data is only to be stored.

3-232. The Learn Mode.

3-233. One method of programming the instrument is to use the PRS (preset) command and then program the control settings as necessary. Another method involves the Learn Mode. To use this method, the instrument controls are set up manually in the LOCAL mode of operation. The switch settings may then be stored in the controller by accessing the five switch registers using the LFM (list from memory) command. At a later time when it is desirable to duplicate the same switch settings, the controller may write the switch settings back into the five switch registers using the WTM (write to memory) command.

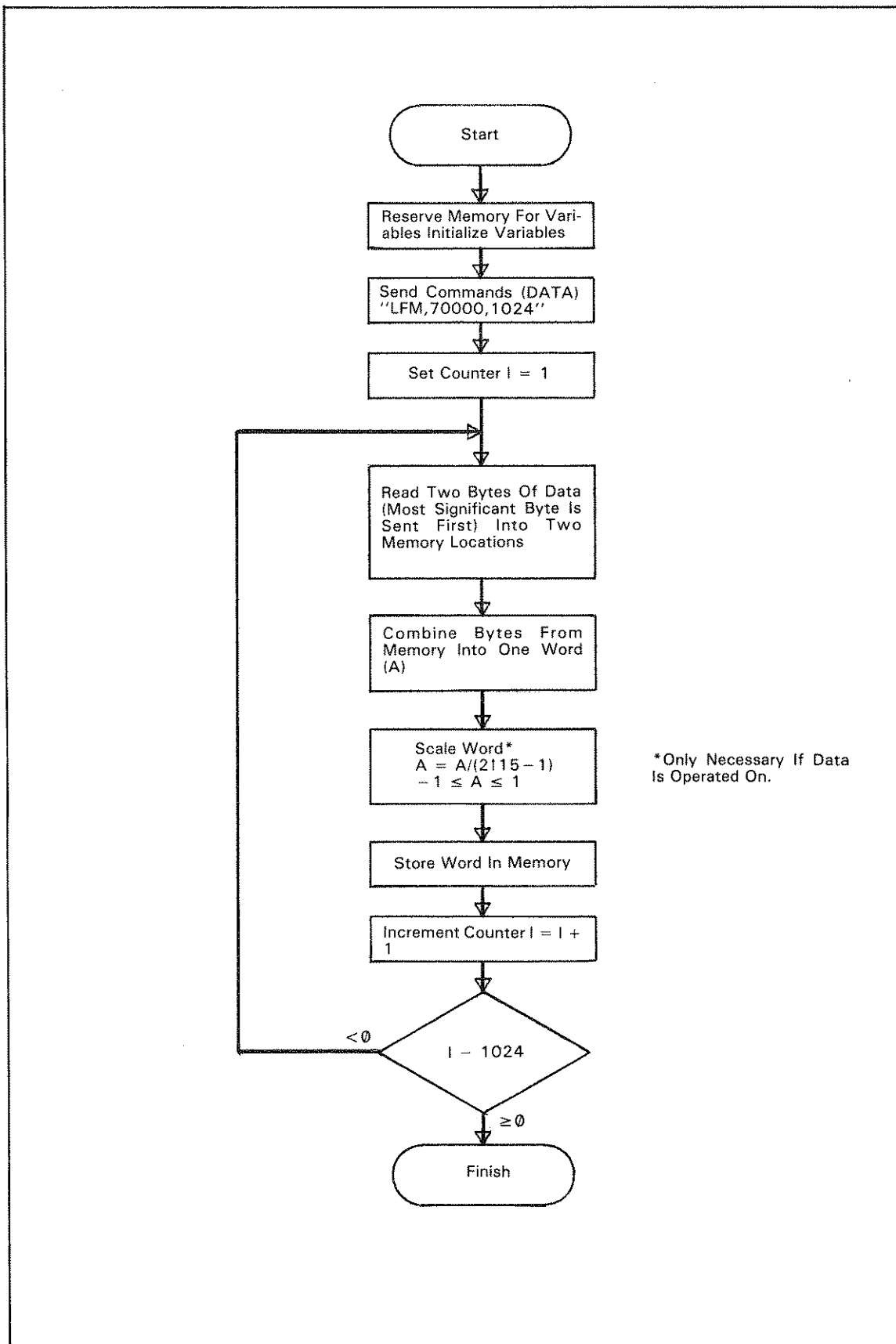

Figure 3-47. Reading Binary Data From Memory.

3-234. Program Example: The Learn Mode (reading and writing to memory).

-hp- 9825A

META Equivalent

```
0: "program to
  demo learn mode
  ";
```

```
1: dim A[10]
2: dsp "learn
  mode demonstrat
  ion"
```

```
3: wrt 711,"LFM,
  77454,5"
```

```
4: rdb(711)+A[1]
```

```
5: for I=2 to 10
```

```
6: rdb(711)+A[I]
  ;next I
```

```
7: beep;dsp "swi
  tch settings
  learned"
```

```
8: wait 1000;
  beep
```

```
9: lcl 711;beep
```

```
10: dsp "press
  cont to reproar
  am 3582"
```

```
11: stop
```

```
12: wrt 711,"WTM
  ,77454,5"
```

```
13: wtb 711,A[1]
```

```
14: for I=2 to
  10
```

```
15: wtb 711,A[I]
```

```
16: next I
```

```
17: beep;end
```

```
*8362
```

REMOTE

DATA: LFM,77454,5

DATA: Most significant 8 bit byte

DATA: Least significant 8 bit byte;
remaining input alternates between
MSB and LSB (bytes)

LOCAL

REMOTE

DATA: WTM,77454,5

DATA: Most significant 8 bit byte

DATA: Least significant 8 bit byte;
remaining output alternates between
MSB and LSB (bytes).

3-235. Program Example: Plotting the Display.

-hp- 9825A

META Equivalent

```

0: "program to
plot and annota
te display on
a 9862 plotter"
:
1: dim A[512],
A#[130]
2: wrt 711,"LDS"
3: red 711
4: for I=1 to
256:red 731,
A[I]
5: next I
6: ent "Ymax",B,
"Ymin",C
7: scl 1,256,C,B
8: axe 1,C,25.6,
(B-C)/8
9: plt 1,C,1
10: for I=1 to
256
11: plt I,A[I]
12: next I
13: wrt 711,"LAN
";red 711,A#
14: .97*(B-C)+
C+E
15: plt 20,E,1;
csiz ;lbl A#[1,
32]
16: plt 147,E,1;
lbl A#[65,96]
17: .93*(B-C)+
C+E
18: plt 20,E,1;
lbl A#[33,64]
19: plt 147,E,1;
lbl A#[97,128]
20: plt 256,B,1;
end
*13545

```

REMOTE
DATA: LDS

DATA: Each point $\pm N.NNE \pm NN$
separated by commas;
CRLF sent last

DATA: LAN
DATA: 128 ASCII characters, CRLF

SECTION III PART III OPERATIONAL VERIFICATION

3-236. OPERATIONAL VERIFICATION.

3-237. The following set of tests check selected specifications in their worst-case condition to provide a relatively short but high (95%) confidence level verification for proper operation of the 3582A. This verification should be used for incoming inspection and instrument check out after a minor repair has been completed. For complete specification verification, refer to the Performance Test Section.

3-238. Required Test Equipment.

3-239. If the recommended equipment is not available, equipment meeting the critical specifications given in Table 3-5 may be substituted. Listed in Table 3-6 are recommended test accessories.

3-240. Preset.

3-241. Preset refers to a mode in which the 3582A front panel switches should be set prior to the initiation of each test sequence. The switch settings are given as follows (line switch excepted):

Button Positions:  ON  OFF

- Set both framed buttons.....ON
- Set AMPLITUDE A.....ON
- Set SCALE.....10 dB/DIV
- Set PASSBAND SHAPE.....FLAT TOP
- Set AVERAGE NUMBER 4.....ON
- Set all other buttons.....OFF
- AMPLITUDE REFERENCE LEVEL.....NORM (Position 1)
- FREQUENCY MODE.....0-25 kHz
- SPAN.....25 kHz
- TRIGGER LEVEL.....FREE RUN
- INPUT CHANNEL A SENSITIVITY.....+ 30 dBV
- VERNIER.....CAL
- INPUT CHANNEL B SENSITIVITY.....+ 30 dBV
- VERNIER.....CAL
- INPUT MODE.....A

3-242. Instrument Warmup.

3-243. Before any of the Operational Verification tests are performed, be sure that all equipment associated with the test is functioning within specified operating limits. The 3582A requires at least two minutes of warmup before any test is performed.

Table 3-5. Recommended Test Equipment for Operational Verification.

Test	Instrument	Critical Specification	Recommended Model
Amplitude Accuracy and Flatness	Sine wave source	Amplitude accuracy of ± 0.1 dB, flatness (1 kHz – 25 kHz) ± 0.05 dB output ≥ 3.2 V rms into 50 Ω	-hp- 3330B Opt. 005 or -hp- 3320B
Noise Level	Sine wave source	S/N ratio 80 dB or better	-hp- 339A or -hp- 204D
Harmonic Distortion	Sine wave source	All harmonics down at least 80 dB from the fundamental	-hp- 339A
Common Mode Rejection	Sine wave source	NA	-hp- 3330B Opt. 005 or -hp- 339A or -hp- 204D
Frequency Accuracy	Sine wave source with counter or Frequency Synthesizer	Frequency accuracy $\pm 0.001\%$ of setting at 25 kHz	-hp- 3330B Opt. 005 or -hp- 3320B or -hp- 3335A

Table 3-6. Recommended Test Accessories.

Description	Part No. (Model No.)
Test Leads: 112 cm (44 in): dual banana both ends 112 cm (44 in): dual banana to BNC	-hp- Model 11000A -hp- Model 11001A
Adapters: Shielded dual banana to BNC male Dual banana to BNC male Dual banana to BNC female	Pamona 1555-C-18 -hp- Part No. 1251-2277 -hp- Model 10110A
Termination: 50 Ω feedthrough 1 k Ω ¼ W 5%	-hp- Model 11048C -hp- Part No. 0683-1025

3-244. Perform the following steps:

- a. Verify that all test equipment is operating under the proper conditions.
- b. Connect the 3582A to a suitable power receptacle using the power cord provided with the instrument. **DO NOT FLOAT THE 3582A USING A POWER PLUG ADAPTER!**
- c. Set the 3582A front panel switches to the preset mode and turn the LINE switch to ON.

d. Allow at least two minutes of warmup time for the 3582A before performing any of the Operational Verification tests.

3-245. DC BAL Verification.

3-246. Before performing any of the following tests, verify that the DC BAL (offset) is not excessively out of adjustment.

3-247. Perform the following steps:

- a. Verify that the 3582A switches are in the preset mode.
- b. Short the input terminals of channel A.
- c. Press the TIME A button and verify that the trace is at the center horizontal graticule. If it is not, correct its position by adjusting the channel A BAL control.
- d. Perform steps b and c for channel B after setting the INPUT MODE switch to B, AMPLITUDE A to OFF, and AMPLITUDE B to ON.

3-248. ROM Self Test.

3-249. Because the 3582A is highly dependent upon internal firmware for operation, it is recommended that the ROM Self Test be performed before other tests are initiated. If the test fails, refer to Troubleshooting, Section VIII of the Service Manual.

NOTE

The following test requires that the 3582A be in the LOCAL mode of operation.

3-250. The ROM self test checks the firmware program stored in each ROM by summing together the data bits in a known binary sequence. This sum is then compared to a known result which is stored in the last two locations in each ROM.

3-251. Perform the following steps:

- a. Set AVERAGE NUMBER 32 to ON.
- b. Hold AVERAGE RESTART button in while RESET (orange button) is pressed and then released. Release the AVERAGE RESTART button and press and release it again.
- c. The test will then begin to run as indicated in the upper left-hand corner of the display by a mnemonic RU.
- d. After approximately 5 seconds, the RU will change to OK indicating that the test passed or an ER indicating that the test failed. Press RESET to return the instrument to the normal operating mode.

3-252. Display Accuracy.

3-253. The display accuracy test checks the alignment of the trace, both vertically and horizontally on the CRT graticules.

3-254. Required Test Equipment. None.**3-255. Instrument Control Setup.**

3582A: Preset
 MARKER ON
 SCALE 2 dB/DIV

3-256. Perform the following steps.

a. The marker is used to check the horizontal trace alignment by positioning it at the left-hand, center and right-hand graticules. The corresponding marker readouts should be within ± 250 Hz of the correct value (0 Hz, 12500 Hz, 25000 Hz).

b. To check the vertical alignment, set the CHANNEL A SENSITIVITY to CAL and the AMPLITUDE REFERENCE LEVEL to position 9 (fully clockwise). Repeat Step a. When finished, return the AMPLITUDE REFERENCE LEVEL to NORM.

3-257. Calibrator Accuracy.

3-258. This procedure checks the level and flatness of the internally generated "CAL" signal.

3-259. Required Test Equipment. None.**3-260. Instrument Control Setup.**

3582A: Preset
 MARKER ON
 SCALE 2 dB/DIV
 CHANNEL SENSITIVITY (both channels) CAL

3-261. Perform the following steps:

a. Move the marker to 1 kHz. The marker level readout should be $22.0 \text{ dBV} \pm 0.2 \text{ dB}$.

b. Set the 1 kHz level as a relative reference by pressing the Marker SET REF button first and the REL button next. Using this relative reference, measure the amplitudes of all other harmonically related spectra displayed (i.e., 2 kHz, 3 kHz, etc.). The levels should be within $\pm 0.3 \text{ dB}$ of the 1 kHz relative reference level.

c. Repeat Steps a and b for channel B after setting the INPUT MODE switch and AMPLITUDE switch for channel B readings.

3-262. Amplitude Accuracy and Flatness.

3-263. This procedure checks the amplitude accuracy and flatness at selected cardinal points in amplitude and frequency. These points exhibit a worse case condition due to the accumulated errors throughout the instrument. Passing this test assures that all other points are at least as accurate as these points.

3-264. Required Test Equipment.

-hp- 3330B Option 005 or 3320B Synthesizer
 Compatible shielded (coax) interconnecting cables with appropriate adapters
 Termination: 50 ohms

3-265. Instrument Control Settings.

3582A: Preset
 MARKER ON

3330B (3320B)
 FREQUENCY.....2.5 khz
 AMPLITUDE.....23.01 dBm
 LEVELING.....FAST (ON)

3-266. Perform the following steps.

- a. Connect the output of the 3330B to channel A via suitable cables and adapters and terminate in 50 ohms.
- b. Verify the amplitude accuracy and flatness by performing the operations indicated in Table 3-7.
- c. Connect the 3330B output to channel B. Repeat Step b for channel B by switching the INPUT MODE switch and AMPLITUDE buttons for channel B.

Table 3-7. Amplitude Accuracy and Flatness.

Set 3330B AMPLITUDE dBm 50	Set 3582A SENSITIVITY dBV	Vrms	dBV	Set 3330B FREQUENCY and read MARKER at frequency	
				2.5 kHz	22.5 kHz
23.01	+ 30	3.162	+ 10	+ 10 ± 0.5	+ 10 ± 0.5
23.01	+ 10	3.162	+ 10	+ 10 ± 0.5	+ 10 ± 0.5
3.01	- 10	0.3162	- 10	- 10 ± 0.5	- 10 ± 0.5

3-267. Noise Level.

3-268. The noise level test insures that all noise internal to the analyzer is at least 70 dB below full scale. The test requires a source with a signal-to-noise ratio of at least 80 dB.

3-269. Required Test Equipment.

-hp- 339A Distortion Measuring Set
 Compatible shielded (coax) interconnecting cables with appropriate adapters
 Termination: 1 kΩ ¼W 5%, -hp- Part No. 0683-1025

3-270. Instrument Control Settings.

3582A: Preset
 MARKER ON

SENSITIVITY (both channels)..... - 10 dBV
 AVERAGE NUMBER..... 32
 FREQUENCY MODE..... 0-START

339A:

OSCILLATOR OUTPUT LEVEL..... 0.3 V rms
 FREQUENCY..... 25 kHz

3-271. Perform the following steps.

a. Connect the oscillator output of the 339A to channel A of the 3582A terminated with a 1 k Ω resistor. Verify that the output level is set at 0.3 V rms and the 3582A SENSITIVITY is set to - 10 dBV.

b. Set the 339A output level vernier for a full-scale amplitude without overloading the 3582A. Press AVERAGE RMS and RESTART. The progress of the averaging sequence may be observed by temporarily setting the MARKER ON button to OFF. This will cause the average number to be displayed.

c. Use the marker to verify that all frequencies below 25 kHz have noise less than - 85 dBV. Then set the AVERAGE to OFF.

d. Set the 339A output to 3 mV rms. Set the 3582A INPUT SENSITIVITY to - 50 dBV.

e. Repeat Steps b and c verifying that the noise levels are less than - 120 dBV.

f. Set the 3582A SPAN to 500 Hz and repeat Steps d and e to check for line related noise.

g. Repeat Steps a through f for channel B.

h. Set the 3582A SPAN to 25 kHz, MODE to SET CENTER, and INPUT SENSITIVITY to - 10 dBV. Set the FREQUENCY ADJUST control for a center frequency of 5001 Hz. Set AVERAGE to OFF.

i. Set the 339A FREQUENCY to 5 kHz and the output to 0.3 V rms.

j. Repeat Steps b through e verifying that all non-harmonically related noise (do not include 0 Hz and negative frequencies) is within the stated limits. This test checks for Digital Local Oscillator spurs.

3-272. Harmonic Distortion.

3-273. The harmonic distortion test checks for harmonically related signals which are generated within the instrument when a full scale input is present. To perform this test requires a signal source which has a signal with harmonic distortion products less than - 80 dB below the fundamental.

3-274. Required Test Equipment.

-hp- 339A Distortion Measuring Set
 Compatible shielded (coax) interconnecting cables with appropriate adapters

3-275. Instrument Control Settings.

3582A: Preset

SPAN.....50 Hz
 SENSITIVITY (both channels).....0 dBV
 AVERAGE NUMBER.....8
 AVERAGE OFF
 FREQUENCY MODE.....0-START
 MARKER ON

339A:

FREQUENCY.....10 Hz
 OSCILLATOR OUTPUT LEVEL.....1.0 V

3-276. Perform the following steps.

a. Connect the output of the 339A to both channel A and B via suitable cables and adapters.

b. Set the MARKER POSITION to 10 Hz and adjust the 339A output level for a full scale display without overloading the 3582A. (This can be done faster with a SPAN of 500 Hz.) Set AVERAGE to TIME and set the TRIGGER LEVEL to achieve consistent triggering. Press MARKER SET REF.

c. Set the 3582A AMPLITUDE REFERENCE LEVEL to position 2 (NORM is position 1) and press AVERAGE RESTART.

d. After the average is complete (this takes about 40 seconds), move the marker to the second harmonic. The amplitude of the second harmonic should be less than - 70 dB below full scale.

e. Repeat Step d for the third harmonic.

f. Repeat Steps b through e for channel B after switching the INPUT MODE switch and AMPLITUDE buttons for channel B, resetting the AMPLITUDE REFERENCE LEVEL to NORM, and setting AVERAGE to OFF.

3-277. Common Mode Rejection.

3-278. The common mode rejection test verifies the capability of the 3582A to ignore a signal which appears simultaneously and in phase at both input terminals of a single channel.

3-279. Required Test Equipment.

- hp- 3330B Option 005 or 3320B Synthesizer
- Compatible shielded (coax) interconnecting cables with appropriate adapters

3-280. Instrument Control Settings.

3582A: Preset

MARKER ON

FREQUENCY MODE.....0-START
 SPAN.....100 Hz

3330B (3320B):

AMPLITUDE.....26.89 dBm
 FREQUENCY.....50 Hz
 LEVELING.....SLOW (ON)

3-281. Perform the following steps.

- a. Switch the 3582A ISOL-CHAS switch to ISOL and connect the 3330B output, without a load, to the input of the 3582A channel A.
- b. Using the MARKER POSITION control, set the marker to 50 Hz and press the MARKER SET REF button.

NOTE

If not using a Synthesizer, adjust Oscillator frequency.

- c. Disconnect the 3330B at the input terminal of channel A. Short the input terminals together. Connect the "high" side of the 3330B output to the shorted connection (input terminals) and the "low" side of the 3330B output to the 3582A chassis.
- d. Switch the 3582A SENSITIVITY to +10 dBV and press the MARKER REL button. The amplitude reading should be less than -66 dB.
- e. Repeat Steps a through d with the 3330B FREQUENCY set to 60 Hz. The reading in Step d should be less than -64 dB.
- f. Repeat Steps a through e for channel B by setting the INPUT MODE switch and AMPLITUDE switches for channel B.
- g. Set ISOL-CHAS switch to CHAS.

3-282. Frequency Accuracy.

3-283. The frequency accuracy test checks the frequency measuring capability in the band analysis (SET START, SET CENTER) mode under narrow bandwidth conditions.

3-284. Required Test Equipment.

- hp- 3330B Option 005 Synthesizer
- Compatible shielded (coax) interconnecting cables with appropriate adapters
- Termination: 50 ohms

3-285. Instrument Control Settings.

3582A: Preset
 SENSITIVITY (both channels).....0.3 V
 SPAN.....5 Hz

FREQUENCY MODE.....SET CENTER
 FREQUENCY ADJUST..... 25 kHz
 MARKER ON
 SCALE.....LINEAR

3330B:

FREQUENCY..... 25 kHz
 AMPLITUDE.....2.05 dBm
 LEVELING..... FAST

3-286. Perform the following steps.

- a. Connect the output of the 3330B to input channel A of the 3582A using a 50 ohm termination.
- b. Using the MARKER POSITION control, set the marker to the maximum amplitude of the 25 kHz signal spectra. The marker frequency displayed should be $25000 \text{ Hz} \pm 0.5 \text{ Hz}$.
- c. Repeat Steps a and b for channel B by setting the INPUT MODE switch and AMPLITUDE switches for channel B.

3-287. Phase Accuracy.

3-288. The phase accuracy test checks the phase accuracy by comparing the phase spectral components associated with the harmonics of a triangle wave input.

3-289. Required Test Equipment.

-hp- 3312A Function Generator
 Compatible shielded (coax) interconnecting cables with appropriate adapters

3-290. Instrument Control Settings.**3582A: Preset**

SENSITIVITY (both channels).....0 dBV
 FREQUENCY MODE.....SET CENTER
 SPAN..... 1 kHz
 FREQUENCY ADJUST..... 2750 Hz
 MARKER ON

3312A:

AMPLITUDE..... 1 V
 RANGE..... 1 kHz
 Adjust Frequency..... 2.75
 FUNCTION..... ∇ (triangle)
 SYMMETRY CAL
 TRIGGER..... FREE RUN
 MODULATION SECTION..... OFF

3-291. Perform the following steps.

a. Connect the output of the 3312A to the inputs of channels A and B using appropriate cables and adapters.

b. Adjust the frequency of the 3312A to place the fundamental at the center graticule (2750 Hz \pm 20 Hz). Adjust the 3312A amplitude output to place the amplitude of the fundamental within 3 dB of full scale.

c. Set the 3582A AMPLITUDE A to OFF and the PHASE A to ON. Set the FREQUENCY MODE to 0-25 kHz and the TRIGGER SLOPE to -.

d. Adjust the TRIGGER LEVEL until the phase spectra of the harmonics are as near to zero degrees as possible. Use the MARKER to verify that the center of the sloping portion of the phase components are between $\pm 10^\circ$. If they are not, repeat the TRIGGER LEVEL SETTING. Set the TRIGGER REPETITIVE button to OFF.

e. Using the MARKER POSITION control, set the marker to the center of the sloping segment of the phase spectra of the 5th harmonic. Press the MARKER SET REF button.

f. Put the TRIGGER back into the REPETITIVE mode. Press the MARKER REL button and check that the relative phase variation is less than $\pm 10^\circ$.

g. Repeat Steps d through f for channel B by setting the INPUT MODE switch and PHASE switches for channel B. Set the MARKER REF to OFF.

3-292. Amplitude and Phase Match Between Channels.

3-293. The amplitude and phase match between channels should be within the given tolerances so that comparative functions such as Transfer Function and Coherence will be accurate.

3-294. Required Test Equipment. None.

3-295. Instrument Control Settings.

3582A: Preset

SENSITIVITY (both channels).....	+ 10 dBV
INPUT MODE.....	BOTH
AMPLITUDE XFR.....	ON
AMPLITUDE A.....	OFF
PASSBAND SHAPE.....	UNIFORM
NOISE SOURCE.....	PERIODIC
MARKER.....	ON

3-296. Perform the following steps:

a. Connect the NOISE SOURCE OUTPUT to the inputs of channels A and B via suitable cables with adapters.

b. Using the MARKER POSITION control, move the marker across the screen noting that each marker amplitude reading does not exceed ± 0.8 dB.

- c. Set the AMPLITUDE XFR button to OFF and set the PHASE XFR button to ON.
- d. Move the marker across the screen noting that each marker phase reading does not exceed ± 5 degrees.

3-297. CONTROLS, CONNECTORS AND INDICATORS.

3-298. Introduction.

3-299. The control glossary is located on a foldout which also contains a pictorial of the 3582A. Each pictorial has numerical designators which refer to control group sections. The control group sections are described on adjoining pages.

NOTE

The information contained in the control glossary is of a limited nature. Therefore, it is recommended that Section III Part I be read before operating the instrument.

- 1 **INPUT SECTION:** Two independent input signals can be measured separately or simultaneously. The input circuits can be ac or dc coupled and can be floated.

OVERLOAD: Indicates momentary or continuous overload of the input or the digital filters. The appropriate input sensitivity is obtained by down-ranging until the LED comes on and then backing off one position.

SENSITIVITY: Selects the maximum input level that can be applied to the instrument without overloading.

When set to the CAL position, an internally generated calibrated signal is connected to the measurement path. The signal has a spectral line every 1 kHz and an amplitude of 22 dBV (20 V) as shown.

VERNIER: Provides continuous but uncalibrated attenuation between the major steps. When not in the CAL position, only relative marker operations are valid. Note that this control is not programmable.

INPUT MODE: Determines which input signal is sampled. When set to BOTH, the resolution is cut in half.

COUPLING: Selects ac or dc coupling of the input circuit. When ac coupled the low frequency 3 dB point is < 0.5 Hz. This is easily shown by monitoring the NOISE SOURCE on the 2.5 Hz 0-START span.

DC coupling is used for signals with components of interest below about 10 Hz.

BALANCE: Compensates for dc drift of the input circuits. The temperature related drift is less than $100 \mu\text{V}/^\circ\text{C}$.

ISOL/CHAS: Determines if the input circuit is floating or referenced to chassis ground. In the isolated position safety requirements limit the amount of "float" to 30 volts.

INPUT: High impedance (1 M Ω) input is directly compatible with -hp- 10001A type 10:1 divider probes.

- 2 **FREQUENCY SECTION:** Spans down to 1 Hz full scale with a 0 Hz START FREQUENCY and band analysis spans down to 5 Hz full scale can be selected. In the band analysis mode the frequency adjust control tunes the start or center display frequency.

SPAN MODE: Selects the sweep mode. 0-START refers to an analysis span that starts at dc and SET START or SET CENTER refers to one that does not start at dc. The 0-25 kHz mode is for taking a quick look at the entire spectrum independent of where the span control is set.

SPAN CONTROL: Selects the total width (not per division) of the span to be analyzed. Spans from 5 Hz to 25 kHz in a 1-2-5-10 sequence are available in three of the modes. Spans of 1 and 2.5 are also available in the 0-START modes. If these spans are accidentally selected in band analysis, a diagnostic is written and the 5 Hz span is used. This control determines how long time record collection takes place, therefore, you have to be careful when using spans below about 100 Hz.

ADJUST: Tunes the start or center display frequency in the band analysis modes. The tuned frequency is displayed in the lower left corner of the display.

Note that tuning is locked out when the instrument is in an averaging sequence to prevent the collection of invalid data. The control is an infinite turns RPG with tuning rates which depend on how fast you turn the knob.

- 3 **DISPLAY SECTION:** Amplitude or phase of either or both channels or the transfer function can be displayed. The sampled time waveform and a measurement called the coherence function can also be displayed.

AMPLITUDE: Selects one or more amplitude displays. These buttons must agree with the INPUT MODE switch or a diagnostic will be written.

SCALE: Defines the display as 80 dB or 16 dB in log modes or as voltage in the linear mode.

PHASE: Selects one or more phase displays. As with the AMPLITUDE displays, these buttons must agree with the INPUT MODE switch or you get a diagnostic. In addition, single channel phase requires triggered operation or you get a diagnostic. The scale on these displays is fixed at $50^\circ/\text{division}$ with foldover at $\pm 180^\circ$.

COHERENCE: It is only valid in the dual-channel mode with RMS averaging selected. Any other configuration results in a diagnostic. The scale is a fixed 0.0 to 1.0 percentage scale.

TIME: The Model 3582A is *not* a digital time domain oscilloscope. In the baseband mode the display is composed of every other time sample (the display circuitry can only take 512 points) of the input. For input signals well below the span width the reproduction can be pretty good, but for frequencies near the span width the reproduction is very poor. For the band analysis modes the display is probably useful only in determining the presence or absence of a signal.

AMPLITUDE REFERENCE LEVEL: In the log display modes this offsets the display in 10 dB steps. In the linear mode the full scale sensitivity is increased in a 40-16-8-4 sequence. In all cases this is just an arithmetic scaling operation and does not effect the input level that will cause overloading. Also, since it is a 16 bit arithmetic operation, it does not contribute to the accuracy specification like an IF attenuator would. The most common uses for this control are:

1. To properly scale a transfer function amplitude display.
2. To examine signals below 10% of full scale in the linear mode.

INPUT MODE STATUS: Reflects the setting of the input mode switch.

4 TRIGGER SECTION: Multiple or single shot triggering of a measurement can be initiated by an input signal on channel A of the proper slope and level.

DATA LOADING: Is on while a time record is being collected. When this indicator is not flashing the instrument is not collecting data and may appear to be "hung-up". When this happens the key control settings should be checked (framed functions).

LEVEL CONTROL: Determines the level on the time domain waveform at which the collection of a data record should begin. In the detented FREE RUN position, triggering is initiated by the completion of the previous measurement. Note that while the level can be varied over the entire A/D converter range, there is no way to select a particular value other than trial-and-error. Also this control cannot be programmed.

SLOPE: Determines if triggering will occur on a positive or negative going transition through the trigger level.

REPETITIVE: Determines if multiple successive triggers can occur without an ARM operation. Note that when not in the repetitive mode the instrument will take only one time record. After this, the instrument can appear to be "hung-up"

ARM: Sensitizes the trigger path to initiate time record collection the next time all trigger conditions are satisfied.

ARM INDICATOR: When lit, the unit is armed and waiting for the trigger conditions to be satisfied.

5 PASSBAND SHAPE SECTION: Passband filter shapes are optimized for various measurement situations and can be changed without having to redo a measurement unless averaging is being applied.

FLAT TOP: Optimized for maximum accuracy when measuring discrete spectral lines. This filter contributes less than 0.1 dB of amplitude inaccuracy.

HANNING: Represents a compromise between optimum amplitude accuracy and narrow bandwidth. Its worst case amplitude uncertainty is about 1.8 dB but its 3 dB bandwidth is roughly 40% of that of the FLAT TOP filter.

UNIFORM: Specifies no time domain weighting of the input data. This is used for transient measurements and in conjunction with the built-in pseudorandom noise source and the impulse output (rear panel).

6 AVERAGE SECTION: Digital averaging gives precise, repeatable analysis of random or time varying data.

OFF: Determines whether successive spectral results are averaged or not. Note that when averaging is specified, the unit will stop taking data after the selected number of averages. Under these conditions the instrument may appear to be "hung-up".

RMS: Combines successive amplitude results in a frequency bin using a root-mean-square calculation and phase results using a simple mean calculation. This is operationally equivalent to display smoothing or video filtering in that it reduces noise variations, but does *not* result in enhancement of the signal-to-noise ratio.

TIME: Combines successive time records by finding the mean at each point. This requires a trigger signal that is synchronized with the discrete portion of the signal. Unlike RMS averaging this can result in signal-to-noise enhancement of as much as 24 dB. It is also

.....

much faster than other methods because no intermediate results are calculated. If you try to TIME average without a trigger you get a diagnostic.

PEAK: Keeps the maximum amplitude and corresponding value found in a frequency bin during N successive measurements.

RESTART: Initiates a new averaging sequence. Note that this control actually clears the time record and restarts the measurement process *even* with the averaging turned off. This is probably the easiest way to restart any measurement if you do not like the time record being collected. It can even be used as a manual trigger by putting the unit in the non-repetitive mode.

SHIFT: Functions like a shift button on a calculator to define whether the black average numbers or the blue average numbers are active.

NUMBER: Specifies 4 to 256 averages. EXP gives an exponentially decreasing weight to older data. Exponential weighting works in RMS averaging only. When EXP is selected in the PEAK mode, the instrument will accumulate PEAK data indefinitely.

7 MARKER SECTION: Absolute or relative readout of the X and Y values of the intensified dot marker simplify interpretation of results.

ON: Turns the intensified dot marker on. Normally, about the only reason to ever turn the marker OFF is to view the progress of the average number during an averaging cycle.

REL: Specifies if the marker is to read out in absolute units or in units referenced to the last value saved by a SET REF operation. This can be used to read the difference between two traces as long as they are both of the same type and neither is a stored trace.

SET REF: Defines the present marker values as a reference for subsequent relative measurements.

SET FREQ: Defines the present marker frequency as the value to be used as the start or center frequency for subsequent band analysis measurements. The marker frequency resolution on wide bandwidths (since the marker is $k\Delta f$) may cause the display to be not exactly centered or started. Repositioning the marker and doing SET FREQ again will refine the display because the marker resolution is better on narrower spans.

TRACE: Causes the dot marker to jump from one active trace to the other. Note that the marker will not work on stored traces.

POSITION: Moves the intensified dot marker either right or left on the active trace.

$\pm \sqrt{BW}$: Normalizes the marker reading by the square root of the equivalent noise bandwidth. This gives results as relative or absolute $\text{dBV}/\sqrt{\text{Hz}}$ and corresponds to a noise voltage density in a 1 Hz bandwidth. The equivalent noise bandwidth appears in the lower right corner of the display.

8 TRACE STORAGE SECTION: Two independent display traces can be digitally stored and recalled.

STORE: Digitally stores the trace portion of an active display. Note that the alphanumerics and scale settings are not stored so marker functions do not work on stored traces.

RECALL: Recalls the stored display trace.

A stored trace counts as one of the two allowable display traces.

9 NOISE SOURCE SECTION: A built-in noise source serves as the "real-time" equivalent of a conventional tracking generator.

OUTPUT: Serves as a replacement for the conventional tracking oscillator. The source impedance is low (typically $< 2 \Omega$) and the level varies from nominally 0 V to 0.69 RMS.

LEVEL: Varies the RMS output level from nominally 0 V to 0.69 V at the detented position. Note that this control is not programmable.

SELECTOR: Selects RANDOM or PERIODIC pseudorandom source.

10 X-Y RECORDER SECTION: Front panel controls facilitate the interface with analog X-Y recorders.

PLOT: Initiates an analog X-Y plot. A plot normally takes about 80 seconds but may vary since the output approximates a constant slew rate. Note that none of the alphanumerics are plotted.

I-: Initializes the plotter to the lower left corner for setting plotter controls. Note that pressing this button during a plot will abort the plot and reset the plot circuit—hence the reset notation.

-I: Initializes the plotter to the upper right corner. While not marked, this will also reset the plot circuit during a plot.

11 HP-IB STATUS SECTION: HP-IB is standard and provides full remote programming and flexible data input and output.

LOCAL: Returns the instrument to local control unless an external controller has executed a local lockout command.

REMOTE: Lights when the instrument is under remote HP-IB control.

TALK: Lights when the instrument is addressed to talk via the HP-IB.

SRQ: Lights when an HP-IB syntax error occurs.

LISTEN: Lights when the instrument is addressed to listen via the HP-IB.

12 CRT SECTION: Two digitally stored display traces plus four lines of alphanumeric data provide complete annotated results.

CRT: Displays graphical and alphanumeric data.

ASTIG: The ASTIG control is used in conjunction with the FOCUS control to adjust the CRT spot size (see screwdriver adjustments Section III Part I).

INTENSITY: The INTENSITY control adjusts the brightness of the CRT trace. Since the 3582A has a digital storage display, the INTENSITY can be set at any level without burning the CRT. In the CRT OFF position, the CRT display is disabled. This position should be used if the instrument is left on for long periods and the CRT display is not needed (such as when the unit is under remote control).

FOCUS: Adjusts the CRT spot size (see ASTIG).

GRAT. ILLUM.: Adjusts the graticule scale illumination for photography.

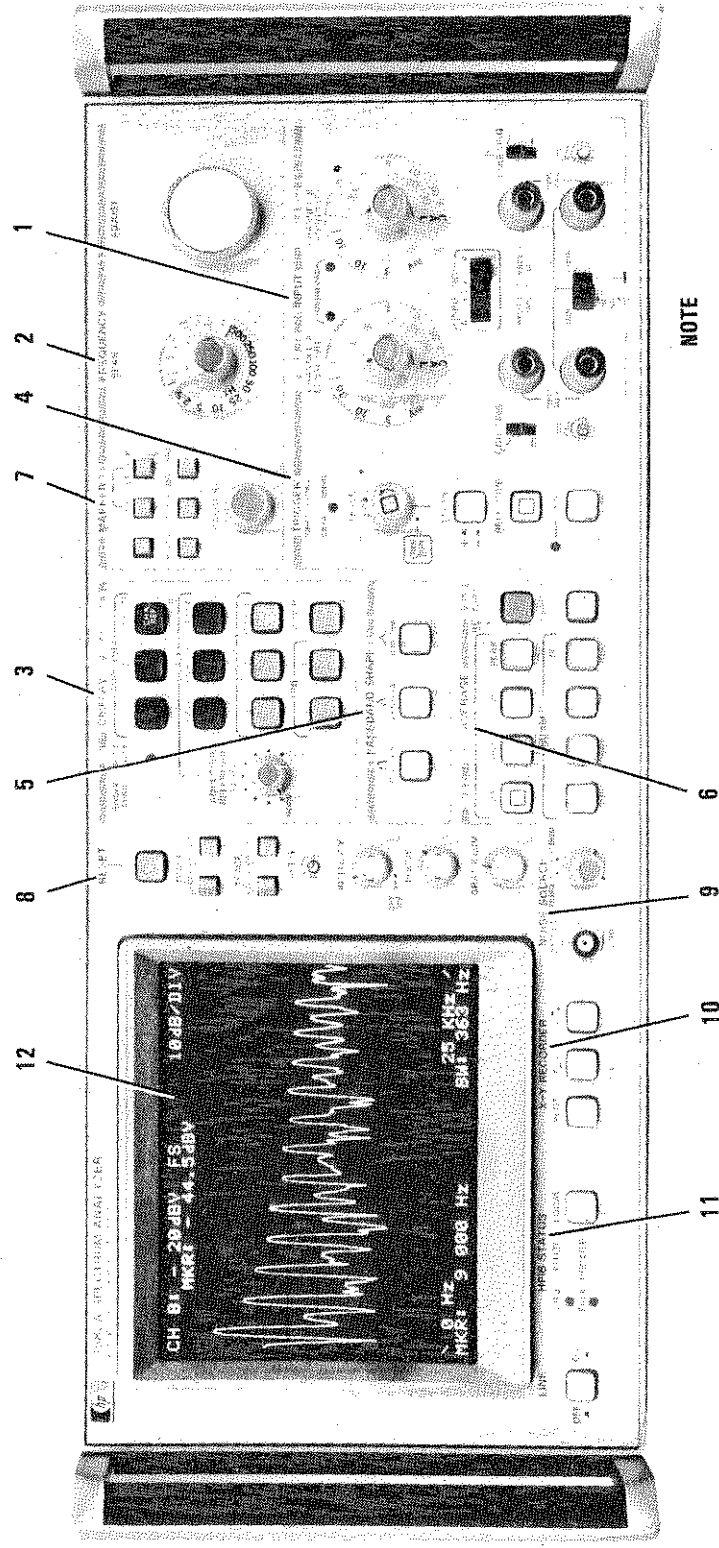

NOTE

The information contained in the Control Glossary is of a limited nature. Therefore, it is recommended that Section III Part I be read before operating the instrument.

Figure 3-48. 3582A Front Panel Controls, Connectors and Indicators.

1 X-Y Recorder Output: The RECORDER output provides a variable output between 0 V and +5 V on the X and Y terminals. The PENLIFT output is a contact closure.

X and Y Axis Output: The X and Y axis BNC connectors output a dc voltage (from 0 to +5.25 V nominal) which is proportional to a position on the CRT as the trace is scanned from left to right. Zero volts on both outputs corresponds to the lower left-hand corner of the display. Alphanumeric are not available on the recorder outputs.

PENLIFT: The penlift output is actuated by a contact closure which shorts the two terminals together during operation.

2 HP-IB Connector: The connector is compatible with the hp-Model 10631 series of HP-IB interconnecting cables. Stacking more than four cables on the connector may lead to the connector and mounting being damaged (see Section II Installation).

HP-IB Connector: The 3582A uses all of the signal lines in the connector. Be sure that none of the contacts are damaged before inserting or after removing a compatible HP-IB cable. HP-IB is Hewlett-Packard's implementation of IEEE Std. 488-1975, "Standard Digital Interface for Programmable Instrumentation". See Section II Installation.

Fastening Nuts: Cable fastening screws have metric threads. Be sure your connector cables are compatible, do not force non-metric screws into the mounting nuts.

3 Impulse Output: The IMPULSE output is a TTL level output and has a period determined by the SPAN and MODE switch settings.

IMPULSE Output: The IMPULSE output is a pulse which has an amplitude of +5 V. The period of the pulse is determined by the setting of the SPAN and MODE switches and can be approximated by the following formula:

$$T_{\text{PULSE}} = \frac{1}{32 \times \text{SPAN (Hz)}}$$

The repetition rate of the pulse is determined by the length of the time record (push the TIME record button to observe the time record length).

4 Trigger Input: A TTL compatible trigger source may be used when the switch is set to EXT and the trigger LEVEL control on the front panel is in FREE RUN.

TRIGGER Input: The TRIGGER input is a TTL compatible input. The front panel SLOPE switch determines which edge of the pulse may initiate the trigger.

Trigger Switch: When this switch is set to EXT, the trigger input is enabled. Note, however, that the front panel trigger LEVEL control must be in the FREE RUN position.

5 Air Filter Screen: The instrument should always be positioned so that unrestricted airflow is available through the air filter screen (see Section II Installation).

Air Filter Screen: The air filter screen should be cleaned periodically by removing and flushing it with soapy water.

Air Filter Mounting Screws: The four screws may be removed for air filter service.

6 Power Input Section: Two switches may be set to the input line voltage level. The line FUSE is accessible as well as the power plug connector (see Section II Installation).

Line Switches: The line switches may be set to one of several combinations of input line voltages.

FUSE: The fuse may be accessed by removing the fuse holder cap. Use only a fuse which is specified for the line voltage selected (see Section II Installation).

Power Line Connector: A three wire cord with the appropriate plug is provided with the instrument. When inserted into the proper power receptacle, the plug grounds the instrument cabinet. **Do not use any power plug adapters to "float" the instrument chassis!**

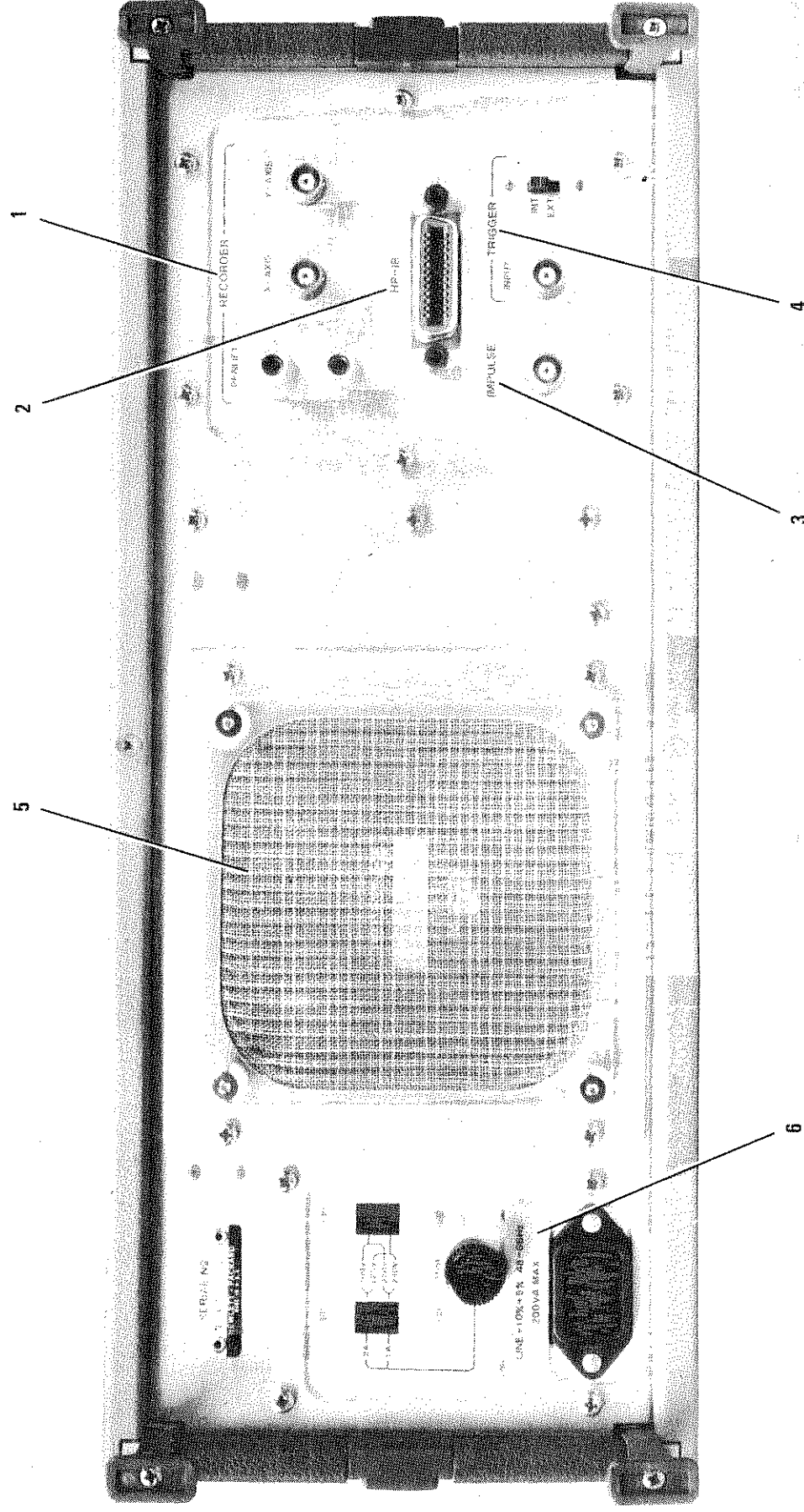

Figure 3-49. 3582A Rear Panel Connectors, Switches, and Filter.

OPERATIONAL VERIFICATION TEST CARD

Hewlett-Packard Model 3582A
Spectrum Analyzer
Serial No. _____

Test Performed By _____
Date _____

ROM Self Test: Pass _____ Fail _____

Display Accuracy:

Frequency (Hz)	012500	25000
Reading ± 250 Hz	_____	_____

Calibrator Accuracy:

		Pass	Fail
25 Amplitude Readings	CH A	_____	_____
(1 kHz to 25 kHz) 22.0 ± 0.2 dBV	CH B	_____	_____

Amplitude Accuracy and Flatness:

Frequency (kHz)	CH A (± 0.5)		CH B (± 0.5)	
	2.5	22.5	2.5	22.5
+ 30	_____	_____	_____	_____
Sensitivity + 10	_____	_____	_____	_____
- 10	_____	_____	_____	_____

Noise:

Span		25 kHz	25 kHz	500 Hz
		Noise Floor	Noise Floor	Line Related
Test		< -85 dB	< -120 dB	Noise < -120 dB
Noise	CH A	_____	_____	_____
	CH B	_____	_____	_____
L.O.	CH A	_____	_____	_____
Spurs	CH B	_____	_____	_____

Harmonic Distortion:

Harmonic	CH A		CH B	
	2nd	3rd	2nd	3rd
Amplitude Reading	_____	_____	_____	_____

Common Mode Rejection:

Marker Amplitude Reading		Frequency	CH A	CH B
		< - 66 dB	50 Hz	_____
< - 64 dB	60 Hz	_____	_____	

Frequency Accuracy:

Reading at 25 kHz \pm 0.5 Hz	CH A _____	CH B _____
--------------------------------	------------	------------

Phase Accuracy:

Maximum Variation at 5th Harmonic < \pm 10°	CH A	Pass	Fail
		CH B	_____

Amplitude and Phase Match Between Channels:

Marker Reading Variation	< \pm 0.8 dB < \pm 5°	CH A		CH B	
		Pass	Fail	Pass	Fail
		_____	_____	_____	_____

APPENDIX A HP-IB COMMAND LIST

NOTE

It is recommended that Section III Part II be read before remote programming the instrument.

Table A-1. HP-IB Command List.

Group	Command		Description
	Function	Setting	
Input & Trigger	IM	1-3	Input Mode (A, Both, B)
	AC	1-2	A Coupling (1 = AC, 2 = DC)
	BC	1-2	B Coupling (1 = AC, 2 = DC)
			1 CAL
			2 30 V, +30 dBV
			3 10 V, +20 dBV
			4 3 V, +10 dBV
	AS	1-10	CH A Sensitivity
			5 1 V, +0 dBV
	BS	1-10	CH B Sensitivity
			6 .3 V, -10 dBV
			7 .1 V, -20 dBV
			8 30 mV, -30 dBV
			9 10 mV, -40 dBV
		10 3 mV, -50 dBV	
	SL	1-2	Slope (1 = +, 2 = -)
	AR		Arm
	RP	0-1	Repetitive
	FR	0-1	Free Run
	AD	0-24999	Adjust (Frequency) (0 = 0 Hz, 24999 = 24999 Hz)
	MD	1-4	Mode (1 = 0-25 kHz, 2 = 0 Start, 3 = Set Start, 4 = Set Center)
Frequency & Marker			1 1 Hz
			2 2.5 Hz
			3 5 Hz
			4 10 Hz
			5 25 Hz
			6 50 Hz
			7 100 Hz
			8 250 Hz
			9 500 Hz
			10 1 kHz
			11 2.5 kHz
			12 5 kHz
			13 10 kHz
			14 25 kHz
	SP	1-14	Span
	MN	0-1	Marker
	MR	0-1	Marker Relative
	MS		Marker Set Ref

Table A-1. HP-IB Command List (Cont'd).

Group	Command		Description
	Function	Setting	
Display	MB	0-1	Marker / \sqrt{BW}
	MT	0-1	Marker Trace
	MF		Marker Set Freq
	MP	0-255	Marker Position (0-127 for dual channel)
	AA	0-1	Amplitude A
	BB	0-1	Amplitude B
	AX	0-1	Amplitude Transfer Function
	SC	1	Scale Linear
	SC	2	Scale 10 dB/Div.
	SC	3	Scale 2 dB/Div.
	PA	0-1	Phase A
	PB	0-1	Phase B
	PX	0-1	Phase Transfer Function
	TA	0-1	Time A
	TB	0-1	Time B
CH	0-1	Coherence	
AM	1-9	Amplitude Ref. Level (Add -10 dB per step, 2 = -10 dB, 9 = -80 dB)	
Passband Shape	PS	1	Flattop
	PS	2	Hanning
	PS	3	Uniform
Average	AV	1	Off
	AV	2	RMS
	AV	3	Time
	AV	4	Peak
	RE		Restart
	NU	1	Number 4/64
	NU	2	Number 8/128
	NU	3	Number 16/256
NU	4	Number 32/Exp	
SH	0-1	Shift	
Trace Storage & Recall	TS		Trace 1 Store
	TR	0-1	Trace 1 Recall
	RS		Trace 2 Store
	RR	0-1	Trace 2 Recall
X-Y Recorder	PL		X-Y Plot
	LL		↓ - Lower Left & Reset
	UR		→ ↑ (Upper Right)

Table A-2. Special Commands (See Section III Part II).

Group	Command	Description																		
Listing Commands	LAD	List frequency adjust value NNNNN.N CRLF																		
	LMK	List marker amplitude and frequency $\pm N.NNNE \pm NN, NNNNN$ CRLF																		
	LSP	List span (Hz) NNNNN CRLF																		
	LAS	List Ch A sensitivity																		
	LBS	List Ch B sensitivity																		
	LXS	List transfer function sensitivity																		
	LDS	List display (128, 256, or 512 points in corresponding units) each point $\pm N.NNE \pm NN$ separated by commas; CRLF																		
	LAN	List alphanumerics (128 ASCII characters, CRLF; representing the four 32 character lines)																		
Binary Memory I/O	LFM,M,N	List from memory																		
	WTM,M,N	Write to memory M = Start Address (Octal) N = Number of words to be transferred (decimal) Input is in 2N 8-bit bytes Most significant byte first																		
Writing Display Alphanumerics	WTA 1-4, 32 ASCII Characters	Inputs a 32 character string to alpha line 1 to 4 (top to bottom) of display. Use blanks where needed to complete 32 character count.																		
Processor Control	HLT	Unconditional halt at next HP-IB branch point																		
	RUN	Unconditional run																		
Status Word	LST0 LST1	<p>List status word (0 Resets Bits After Reading)</p> <p style="text-align: center;">One 8-Bit Byte</p> <table border="0" style="width: 100%;"> <thead> <tr> <th style="text-align: left;">Bit</th> <th style="text-align: left;">Value</th> <th style="text-align: left;">Meaning</th> </tr> </thead> <tbody> <tr> <td>0</td> <td>1</td> <td>Diagnostic on screen. Indicates current switch setting is invalid. Set and cleared by 3582.</td> </tr> <tr> <td>1</td> <td>2</td> <td>Arm light is on. Set and cleared by 3582 to agree with arm light on front panel.</td> </tr> <tr> <td>2*</td> <td>4</td> <td>A overload. Set by 3582 when: 1)Time record is moved to FFT area or time record is complete 2)and hardware overload has occurred 3)and A or BOTH INPUT MODE.</td> </tr> <tr> <td>3*</td> <td>8</td> <td>B overload. Same as A.</td> </tr> <tr> <td>4*</td> <td>16</td> <td>Time record complete. Set when 1024 new time points have been taken since last record complete.</td> </tr> </tbody> </table>	Bit	Value	Meaning	0	1	Diagnostic on screen. Indicates current switch setting is invalid. Set and cleared by 3582.	1	2	Arm light is on. Set and cleared by 3582 to agree with arm light on front panel.	2*	4	A overload. Set by 3582 when: 1)Time record is moved to FFT area or time record is complete 2)and hardware overload has occurred 3)and A or BOTH INPUT MODE.	3*	8	B overload. Same as A.	4*	16	Time record complete. Set when 1024 new time points have been taken since last record complete.
Bit	Value	Meaning																		
0	1	Diagnostic on screen. Indicates current switch setting is invalid. Set and cleared by 3582.																		
1	2	Arm light is on. Set and cleared by 3582 to agree with arm light on front panel.																		
2*	4	A overload. Set by 3582 when: 1)Time record is moved to FFT area or time record is complete 2)and hardware overload has occurred 3)and A or BOTH INPUT MODE.																		
3*	8	B overload. Same as A.																		
4*	16	Time record complete. Set when 1024 new time points have been taken since last record complete.																		

Table A-2. Special Commands (Cont'd).

Group	Command	Description		
		5*	32	Single sweep spectrum complete. Set when time complete data has been FFT'D and displayed. Use LST1 to check this flag! It depends on internal flags which are cleared by LST0.
		6*	64	Average complete.
		7*	128	X-Y plot complete.
Preset	PRS	Preset command		
		Causes instrument to go into the following control state: (25 kHz, 1 channel)		
		Switch	Setting (when applicable)	
		Coupling	AC (Channels A & B)	
		Input Mode	Channel A	
		Sensitivity	30 V (Channels A & B)	
		Level	Free Run	
		Repetitive	On	
		Arm	Off	
		Trigger Slope	—	
		Marker	Off	
		Marker Relative	Off	
		Marker $\div \sqrt{BW}$	Off	
		Mode	0-25 kHz Baseband	
		Span	25 kHz	
		Amplitude	A (B&XFR-OFF)	
		Scale	10 dB/Div	
		Phase	None	
		Time	None	
		Coherence	Off	
		Amplitude Ref Lev	Normal	
		Passband	Flat Top	
		Average	Off	
		Average Number	4	
		Average Shift	Off	
		Trace 1 Store	Off	
		Trace 1 Recall	Off	
		Trace 2 Store	Off	
		Trace 2 Recall	Off	

Table A-3. Memory Locations.

Description	Start Address (M, Octal)	Number of Words (N, Decimal)	Binary Format
Time Record	70000	1024	Numeric
Display	74000	512	Alphanumeric
Front Panel Switches	77454	5	Numeric

APPENDIX B

CONDENSED DESCRIPTION OF THE HEWLETT-PACKARD INTERFACE BUS

GENERAL BUS DESCRIPTION.

The Hewlett-Packard Interface Bus (HP-IB) is a carefully defined instrumentation interface which simplifies the integration of instruments, calculators, and computers into systems. It minimizes compatibility problems between devices and has sufficient flexibility to accommodate future products. The Hewlett-Packard Interface Bus has been formally proposed to the International Electrotechnical Commission (I.E.C.), as an international standard, and to the Institute of Electrical and Electronic Engineers (I.E.E.E.) as an American standard.

The HP-IB employs a 16 line Bus to interconnect up to 15 instruments. This Bus is normally the sole communication link between the interconnected units. Each instrument on the Bus is connected in parallel to the 16 lines of the Bus. Eight of the lines are used to transmit data and the remaining eight are used for communication timing (Handshake), and control.

Data is transmitted on the eight HP-IB data lines as a series of eight-bit characters referred to as "bytes". Normally, a seven-bit ASCII (American Standard Code for Information Interchange) code is used with the eighth bit available for a parity check, if desired. Data is transferred by means of an interlocked "handshake" technique. This sequence permits asynchronous communication over a wide range of data rates.

Communication between devices on the HP-IB employs the three basic functional elements listed below. Every device on the Bus must be able to perform at least one of these functions:

- a. **LISTENER** – A device capable of receiving data from other instruments. Examples of this type of device are: printers, display devices, programmable power supplies, programmable signal sources and the like.
- b. **TALKER** – A device capable of transmitting data to other instruments. Examples of this type of device are: tape readers, voltmeters that are outputting data, counters that are outputting data, and so on.
- c. **CONTROLLER** – A device capable of managing communications over the HP-IB such as addressing and sending commands. A calculator or computer with an appropriate I/O interface is an example of this type of device.

An HP-IB system allows only one device at a time to be an active talker. Up to 14 devices may simultaneously be listeners. Only one device at a time may be an active controller.

BUS STRUCTURE.

The HP-IB interface connections and Bus structure are shown in Figure 1.

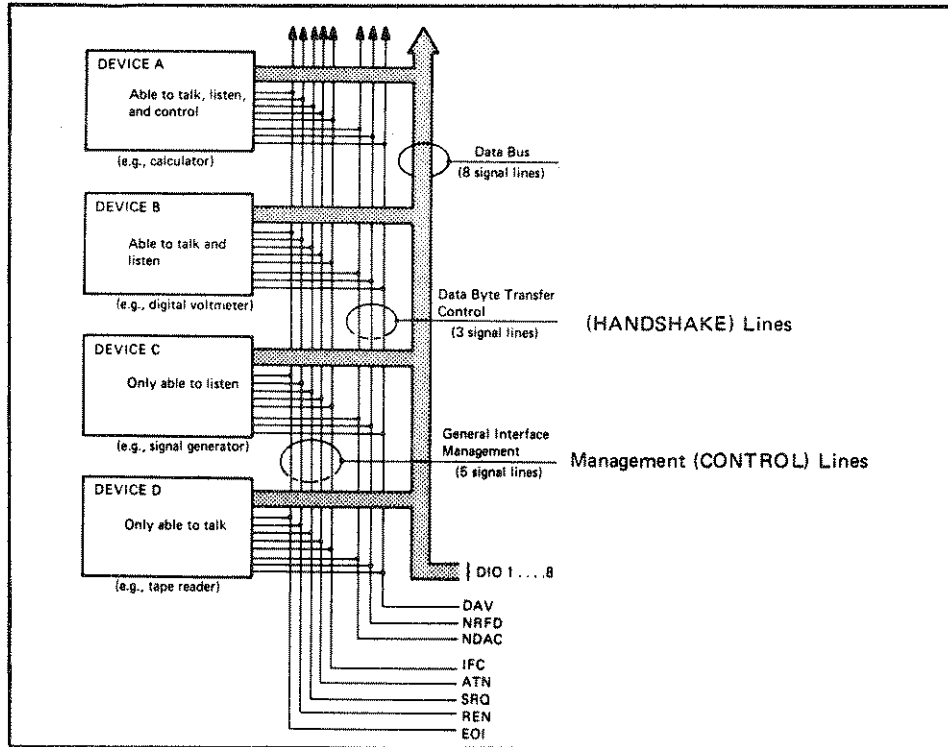

Figure 1. Interface Connections and Bus Structure.

Management (CONTROL) Lines.

The active controller manages all Bus communications. The state of the ATN (attention) line, determined by the controller, defines how data on the eight data (DIO) lines will be interpreted by the other devices on the Bus. When ATN is low (true), the HP-IB is in Command Mode. In Command Mode the controller is active and all other devices are waiting for instructions. Command Mode instructions which can be issued by the Controller in "Command Mode" include:

a. Talker Address —

A seven bit code transmitted on the HP-IB which enables a specific device to talk. Only one Bus device at a time may act as the talker. When the controller addresses a unit to talk the previous talker is automatically unaddressed and ceases to be a talker. Confusion would result if more than one device were allowed to talk at a time.

b. Listener Address —

A seven-bit code transmitted on the HP-IB which enables a specific device to listen. Several Bus devices at a time (up to 14) may be listeners.

c. Universal Commands —

Bus devices capable of responding to these commands from the controller will do so at any time regardless of whether they are addressed. These commands will be covered in more detail later.

d. Addressed Commands —

These commands are similar to universal commands except that they are recognized only by devices that are addressed as listeners.

e. Unaddress Commands –

1. “Unlisten” Address Command –

This command unaddresses all listeners that have been previously addressed to listen.

2. “Untalk” Address Command –

This command unaddresses any talker that had been previously addressed to talk.

Bus Commands.

In “Command Mode” one or more special codes known as “bus commands” may be placed on the HP-IB. These commands have the same meaning in all Bus systems. Each device is designed to respond to those commands that have a useful meaning to the device and will ignore all others. The operating manual for each device will state which Bus commands it will obey.

Bus commands fall into three categories.

1. Universal commands affect all responding devices on the Bus, whether addressed or not.
2. Addressed commands affect only responding devices which are addressed to listen. Addressed commands allow the controller to initiate a simultaneous action from a selected group of devices on the Bus.
3. Unaddress commands are obeyed by all addressable devices. These commands unaddress devices that are currently addressed.

The Bus commands are summarized in Table 1.

Service Request and Serial Polling.

Some devices that operate on the interface bus have the ability to request service from the system controller. A device may request service when it has completed a measurement, when it has detected a critical condition, or for any other reason. Service request is initiated when a device sets the HP-IB line labeled SRQ low. The controller has the option of determining when or if a service request will be serviced. The following sequence is used to respond to a service request:

- a. The controller checks for the presence of a service request.
- b. If a service request is present, the controller sets the serial poll mode. *The serial poll mode is initiated by the controller transmitting the Universal Command “SPE” (ASCII character “CAN” [Octal 030]) in the “Command Mode”.*
- c. The controller polls one of the devices that may have requested service. It then polls the next device, and so on. *Once the serial poll mode has been enabled, responding devices on the Bus are prepared to accept a serial poll. This is done by setting ATN, addressing the device as a talker, and then removing ATN. If the device has requested service, it will respond by setting DIO line 7 low. Other DIO lines may also be set low indicating the nature of the service request.*
- d. For each device that has requested service, the controller takes appropriate action.

Table 1. Summary of Bus Commands.

	COMMAND	ASCII Character	OCTAL CODE	PURPOSE
UNADDRESS COMMANDS	UNL UNLISTEN	?	077	Clears Bus of all listeners.
	UNT UNTALK	—	137	Unaddresses the current talker so that no talker remains on the Bus.*
UNIVERSAL COMMANDS	LLO Local Lockout	DC1	021	Disables front panel local-reset button on responding devices.
	DCL Device Clear	DC4	024	Returns all devices capable of responding to pre-determined states, regardless of whether they are addressed or not.
	PPU Parallel Poll Unconfigure	NAK	025	Sets all devices on the HP-IB with Parallel Poll capability to a predefined condition.
	SPE Serial Poll Enable	CAN	030	Enables Serial Poll Mode on the Bus.
	SPD Serial Poll Disable	EM	031	Disables Serial Poll Mode on the Bus.
ADDRESSED COMMANDS	SDC Selective Device Clear	EOT	004	Returns addressed devices, capable of responding to pre-determined states.
	GTL Go to Local	SOH	001	Returns responding devices to local control.
	GET Group Execute Trigger	BS	010	Initiates a simultaneous pre-programmed action by responding devices.
	PPC Parallel Poll Configure	ENQ	005	This command permits the DIO lines to be assigned to instruments on the Bus for the purpose of responding to a parallel poll.
	TCT Take Control	HT	011	This command is given when the active controller on the Bus transfers control to another instrument.

*NOTE

Talkers can also be unaddressed by transmitting an unused talk address on the Bus.

e. When all devices have been polled, the controller terminates the serial poll mode by issuing the Universal Command SPD (ASCII Character "EM", [Octal 031]).

The full sequence of operations is not necessary in all cases. For example, a system may have only one device that requests service and then only for a single purpose. When the controller detects a service request, the source of the request and the appropriate action is known immediately. Thus the use of the service request and the serial poll depends entirely on the make-up of each system and the devices involved.

Parallel Poll.

Parallel polling permits the status of up to eight devices on the HP-IB to be checked simultaneously. The operator assigns each device a data line (DIO1 thru DIO8) which the device sets low during the parallel poll routine if it requires service. More devices can be handled, if desired, by sharing the use of each DIO line.

The parallel polling function requires the controller to periodically poll the instruments connected to the Bus. The controller interrogates (polls) the instruments by sending an EOI with ATN activated. When either EOI or ATN is removed, the controller stops polling.

Code Summary.

A code assignment summary is shown in Table 2. These assignments apply only when operating in "Command Mode".

In "Data Mode" there are no specific code assignments. However, the devices communicating in this mode must agree on the meaning of the codes they use.

The set of codes labeled "Primary Command Group" are the codes commonly used to communicate on the HP-IB. The "Secondary Command Group" is used when addressing extended listeners and talkers, or enabling the Parallel Poll Mode.

Other Bus Lines.

The three remaining HP-IB lines and their functions are:

- REN (Remote Enable) – The system controller sets REN low and then addresses the devices to Listen before they will operate under remote control.
- IFC (Interface Clear) – Only the system controller can activate this line. When IFC is set (true) all talkers, listeners and active controllers go to their inactive states.
- EOI (End or Identify) – This line is used to indicate the end of a multiple byte transfer sequence or, in conjunction with ATN, to execute a parallel polling sequence.

NOTE

Individual instruments, at power-on, can momentarily set the IFC line to a true state.

Address Codes.

Devices with the functional capability of talker normally recognize a single byte address*. A certain group of ASCII seven-bit bytes is reserved for talk addresses (refer to Table 3). The state of the eighth bit is ignored in the "Command Mode" when addresses are being transmitted. Each device has a unique talk address which can normally be modified. The Talk Address, bits one through five, are individually selected in each device to be either high or low. The selection of these bits allows changing the device talk and/or Listen address.

Devices with the functional capability of Listener normally recognize a single character address**. The seven-bit codes reserved for Listen addresses are listed in Table 3. Each device has a unique listen address which can normally be modified.

NOTE

Bits 6 and 7 determine whether the "address" is a "listen" or "talk" address (see Table 3).

*An "extended talker" is capable of recognizing a two byte talk address.

**An "extended listener" is capable of recognizing a two byte listen address.

Devices with both talk and listen addresses have these addresses assigned in pairs, eg., if the fourth address in the column of listen addresses "F" is selected, the talk address is "C", the fourth address in the talker address column. The talk address is automatically changed whenever the listen address is changed and vice versa. Addresses are normally alterable by the use of switches or jumpers within the instrument.

Listen Addresses								Talk Addresses								
Bits							ASCII Character	Bits							ASCII Character	
b ₈	b ₇	b ₆	b ₅	b ₄	b ₃	b ₂		b ₁	b ₈	b ₇	b ₆	b ₅	b ₄	b ₃		b ₂
X	0	1	0	0	0	0	0	SP	X	1	0	0	0	0	0	@
X	0	1	0	0	0	0	1	!	X	1	0	0	0	0	1	A
X	0	1	0	0	0	1	0	"	X	1	0	0	0	0	0	B
X	0	1	0	0	0	1	1	#	X	1	0	0	0	1	1	C
X	0	1	0	0	1	0	0	\$	X	1	0	0	0	1	0	D
X	0	1	0	0	1	0	1	%	X	1	0	0	0	1	0	E
X	0	1	0	0	1	1	0	&	X	1	0	0	0	1	1	F
X	0	1	0	0	1	1	1	'	X	1	0	0	0	1	1	G
X	0	1	0	1	0	0	0	(X	1	0	0	1	0	0	H
X	0	1	0	1	0	0	1)	X	1	0	0	1	0	0	I
X	0	1	0	1	0	1	0	*	X	1	0	0	1	0	1	J
X	0	1	0	1	0	1	1	+	X	1	0	0	1	0	1	K
X	0	1	0	1	1	0	0	,	X	1	0	0	1	1	0	L
X	0	1	0	1	1	0	1	-	X	1	0	0	1	1	0	M
X	0	1	0	1	1	1	0	.	X	1	0	0	1	1	1	N
X	0	1	0	1	1	1	1	/	X	1	0	0	1	1	1	O
X	0	1	1	0	0	0	0	0	X	1	0	1	0	0	0	P
X	0	1	1	0	0	0	1	1	X	1	0	1	0	0	1	Q
X	0	1	1	0	0	1	0	2	X	1	0	1	0	1	0	R
X	0	1	1	0	0	1	1	3	X	1	0	1	0	0	1	S
X	0	1	1	0	1	0	0	4	X	1	0	1	0	1	0	T
X	0	1	1	0	1	0	1	5	X	1	0	1	0	1	1	U
X	0	1	1	0	1	1	0	6	X	1	0	1	0	1	1	V
X	0	1	1	0	1	1	1	7	X	1	0	1	0	1	1	W
X	0	1	1	1	0	0	0	8	X	1	0	1	1	0	0	X
X	0	1	1	1	0	0	1	9	X	1	0	1	1	0	0	Y
X	0	1	1	1	0	1	0	:	X	1	0	1	1	0	1	Z
X	0	1	1	1	0	1	1	;	X	1	0	1	1	0	1	[
X	0	1	1	1	1	0	0	<	X	1	0	1	1	1	0	\
X	0	1	1	1	1	0	1	=	X	1	0	1	1	1	0]
X	0	1	1	1	1	1	0	>	X	1	0	1	1	1	0	^

X = don't care

Handshake Lines.

Each character byte transferred on the HP-IB data lines employs the three-wire handshake sequence. This sequence has the following characteristics:

1. Data transfer is asynchronous – Data can be transferred at any rate suitable for the devices operating on the Bus. (Data rates up to 500 kilobytes per second are typical; with a maximum of 1 megabyte per second).
2. Devices with different input/output speeds can be interconnected. Data transfer rate automatically adjusts to slowest active device.
3. More than one device can accept data at the same time.

The following definitions are used throughout the remaining text.

Source – A device transmitting information on the Bus in either the Command or Data Mode.

Talker – An “addressed” source in the Data Mode only.

Acceptor – A device receiving information on the Bus in either the Command or Data Mode.

Listener – An “addressed” acceptor in the Data Mode only.

The Data Transfer or “HANDSHAKE” lines are shown in Figure 1. The mnemonics of each line have the following meanings:

DAV – Data Valid
NRFD – Not Ready for Data
NDAC – Not Data Accepted

The handshake timing sequence is illustrated in Figure 2.

Each data byte transferred by the interface system uses the handshake process when exchanging data between source and acceptor. The handshake timing sequence is illustrated in Figure 2. In Data Mode, the source is a Talker and the acceptor is a Listener.

The timing diagram illustrates the handshake process by indicating the actual waveforms on the DAV, NRFD, and NDAC lines. The NRFD and NDAC signals each represent composite waveforms resulting from two or more Listeners accepting the same data byte at slightly different times. This is usually due to variations in the transmission path length and individual instrument response rates (delays).

The flow chart represents the same sequence of events in a different form.

The subscripted letters on the flow chart and the timing diagram refer to the same event on the list of events.

HANDSHAKE line timing diagram for one talker and multiple listeners using the handshake process. Two cycles of the handshake sequence are shown. Also refer to the flow diagram and list of events on this figure.

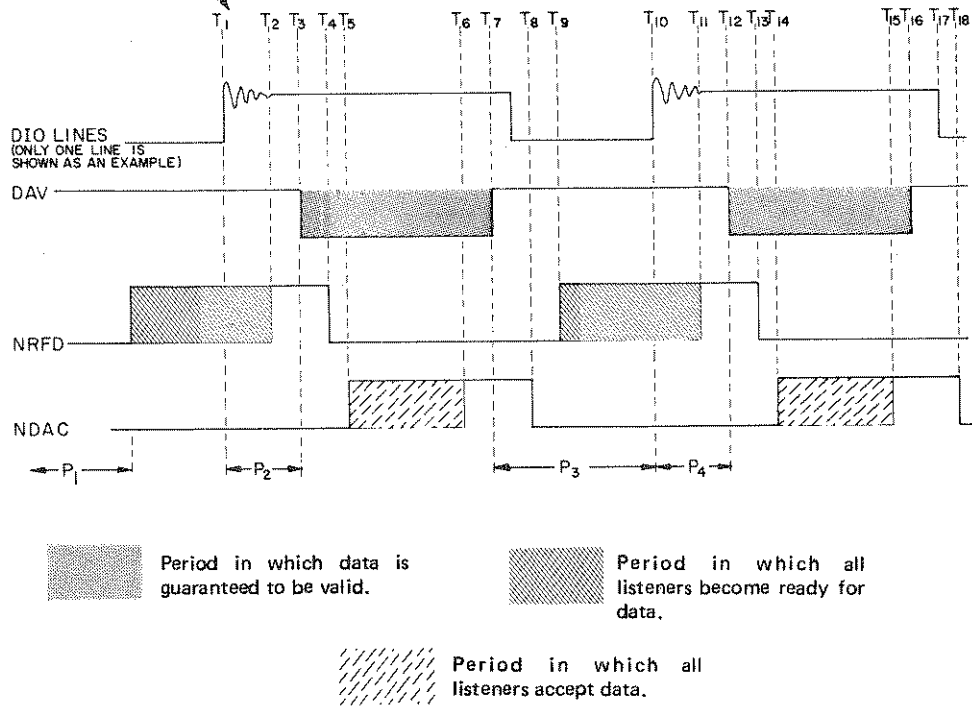

List of Events for Handshake Process

- Source initializes DAV to high (False - data not valid).
- P₁ — Acceptors initialize NRFD to low (True - none are ready for data), and set NDAC to low (True - none have accepted the data).
- T₁ — Source checks for error condition (both NRFD and NDAC high), then places data byte on DIO lines.
- P₂ — Source delays to allow data to settle on DIO lines.

Figure 2. Handshake Timing Sequence.

T ₂	Acceptors have all indicated readiness to accept first data byte; NRFD goes high.
T ₃	When the data is settled and valid, and the source has sensed NRFD high, DAV is set low.
T ₄	First acceptor sets NRFD low to indicate that it is no longer ready, then accepts the data. Other acceptors follow at their own rates.
T ₅	First acceptor sets NDAC high to indicate that it has accepted the data. (NDAC remains low due to other acceptors driving NDAC low).
T ₆	Last acceptor sets NDAC high to indicate that it has accepted the data; all have now accepted and NDAC goes high.
T ₇	Source, having sensed that NDAC is high, sets DAV high. This indicates to the acceptors that data on the DIO lines must now be considered not valid. Upon completion of this step, one byte of data has been transferred.
P ₃ (T ₇ —T ₁₀)	Source changes data on the DIO lines.
T ₈ *	Acceptors, upon sensing DAV high set NDAC low in preparation for next cycle. NDAC goes low as the first acceptor sets it low.
T ₉	First acceptor indicates that it is ready for the next data byte by setting NRFD high. (NRFD remains low due to other acceptors driving NRFD low).
T ₁₀	Source checks for error condition (both NRFD and NDAC high), then places data byte on DIO lines (as at T ₁).
P ₄ (T ₁₀ —T ₁₂)	Source delays to allow data to settle on DIO lines.
T ₁₁	Last acceptor indicates that it is ready for the next data byte by setting NRFD high; NRFD signal line goes high.
T ₁₂	Source, upon sensing NRFD high, sets DAV low to indicate that data on DIO lines is settled and valid.
T ₁₃	First acceptor sets NRFD low to indicate that it is no longer ready, then accepts the data.
T ₁₄	First acceptor sets NDAC high to indicate that it has accepted the data.
T ₁₅	Last acceptor sets NDAC high to indicate that it has accepted the data (as at T ₆).
T ₁₆	Source, having sensed that NDAC is high, sets DAV high (as at T ₇).
T ₁₇	Source removes data byte from DIO signal lines after setting DAV high.
T ₁₈ *	Acceptors, upon sensing DAV high, set NDAC low in preparation for next cycle.
	* Note that all three handshake lines return to their initialized states, as at T ₁ and T ₂ .

Figure 2. Handshake Timing Sequence (cont'd).

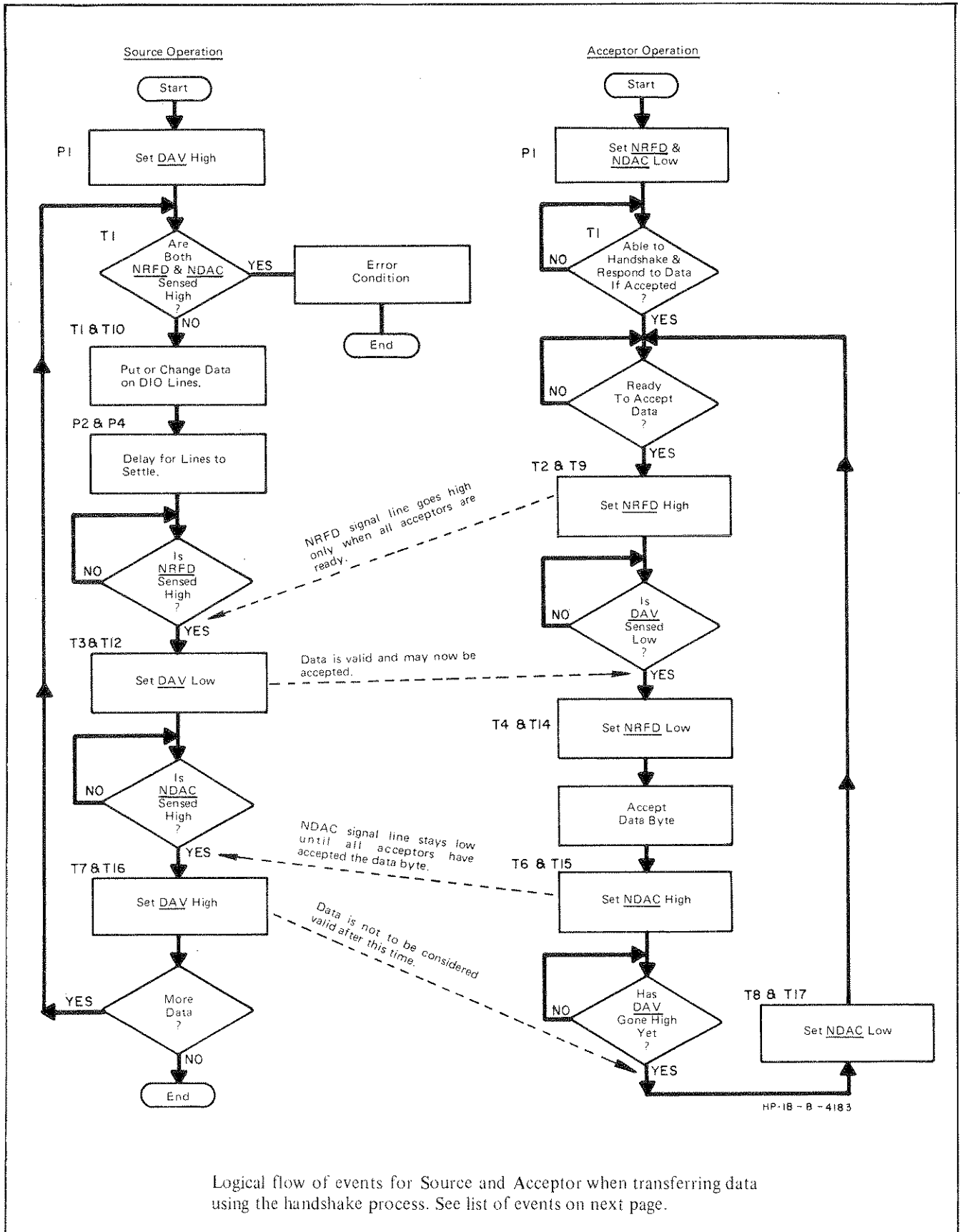

Logical flow of events for Source and Acceptor when transferring data using the handshake process. See list of events on next page.

Figure 2. Handshake Timing Sequence (cont'd).

Data Lines.

A set of eight interface lines is available to carry all seven bit interface messages and device dependent messages. These are DATA INPUT OUTPUT lines, DIO1 through DIO8. Only seven lines are required for transfer of data. The eighth line is usually used for a parity check. The data on the DIO lines is transferred in a bit parallel, byte serial form, asynchronously and bidirectionally.

a. Data Mode –

When ATN (attention) goes high (false), the HP-IB is in the "Data Mode". In this mode data may be transferred between devices that were addressed when the HP-IB was in "Command Mode". Messages that can be transferred in "Data Mode" include:

1. Programming Instructions –

Codes are seven bit bytes placed on the HP-IB data (DIO) lines. The meaning of each byte is device dependent and is selected by the equipment designer. These types of messages are usually between the controller acting as the talker and a single device that has been addressed as a listener.

2. Data Codes –

Data codes are seven-bit bytes placed on the data lines. The meaning of each byte is device dependent. For meaningful communication to occur, both the talker and listener must agree on the meaning of the codes they use.

Data Byte.

Individual data bytes transmitted on the HP-IB can be described in an octal code. The binary bits are separated into groups of three starting from the right-hand side (see Table 3). Within the groups each binary bit is assigned a weight – "1", "2" and "4" respectively. The octal numbers corresponding to each group of bits is the summation of the weights of the binary ones in each group.

NOTE

In Table 3 the hundreds group has two bits rather than three since there are eight data lines. When seven-bit character ASCII code is used the hundreds group contains only one bit which can take on the octal value of "0" or "1".

Table 4. Octal Code Conversion.

Bits	b ₈	b ₇	b ₆	b ₅	b ₄	b ₃	b ₂	b ₁	Octal Code
Weights	"2" (Hundreds)	"1"	"4" (Tens)	"2"	"1"	"4" (Ones)	"2"	"1"	
	1	0	0	1	1	0	1	0	2 3 2
	1	1	1	1	1	0	0	0	3 7 0
	0	1	0	0	1	0	1	1	1 1 3
	0	0	0	1	0	1	1	1	0 2 7

INTERFACE.

A list of the available functions is given in Table 5. Every HP-IB compatible device is able to perform at least one function on the HP-IB. Devices ignore all commands relating to functions they do not have.

Example:

An HP-IB compatible programmable voltage source includes the "listen function" so that it can be programmed to accept data. However, it does not output information so it does not include a "talk function". Therefore, the programmable voltage source would ignore all information on the HP-IB pertaining to the "talk function".

Table 5. HP-IB Instrument Interface Functions.

Interface Functions that may be included in an HP-IB device.	Comments
Source Handshake	This functional capability must be included in any device that can be a "talker" on the bus.
Acceptor Handshake	This functional capability must be included in all devices that can be "listeners".
Talker or Extended Talker*	Capability required for a device to be a "talker".
Listener or Extended Listener*	Capability required for a device to be a "listener".
Service Request	This capability permits a device to asynchronously request service from the controller.
Remote/Local	Provides capability to select between two sources of input information. Local corresponds to front panel controls and remote to the input information from the bus.
Parallel Poll	Provides capability for a device to uniquely identify itself if it requires service and the controller is requesting a response. This capability differs from service request in that it requires a commitment of the controller to periodically conduct a parallel poll.
Device Clear	This function allows a device to be initialized to a pre-defined state. A device with this capability will have the effect of this command described in its operating manual.
Device Trigger	This function permits a device to have its basic (measurement) operation initiated by the talker on the Bus.
Controller	This function permits a device to send addresses, universal commands and addressed commands to other devices on the HP-IB. It may also include the ability to conduct parallel polling to determine devices requiring service.

*Extended Talker and Extended Listener provide increased address capability. Devices with this functional capability recognize addresses that are two bytes in length rather than just one byte.

HP-IB

Bus Operating Considerations.

a. When a device capable of activating IFC is powered on during system operation, it may cause the active controller on the Bus to relinquish control, resulting in errors. The Controller must transmit IFC to regain active Control.

b. Prior to addressing new listeners it is recommended that all previous listeners be unaddressed using the Unlisten Command (?).

c. Only one talker can be addressed at a time. When a new talker is addressed the former talker is automatically unaddressed.

d. The maximum accumulative length of the HP-IB cable in any system must not exceed more than 2 meters of cable per device or 20 meters, whichever is less.

e. For additional programming information consult the HP-IB User Guide for the appropriate calculator.

HP-IB Connector.

Figure 3 shows the pin configuration of the HP-IB Connector.

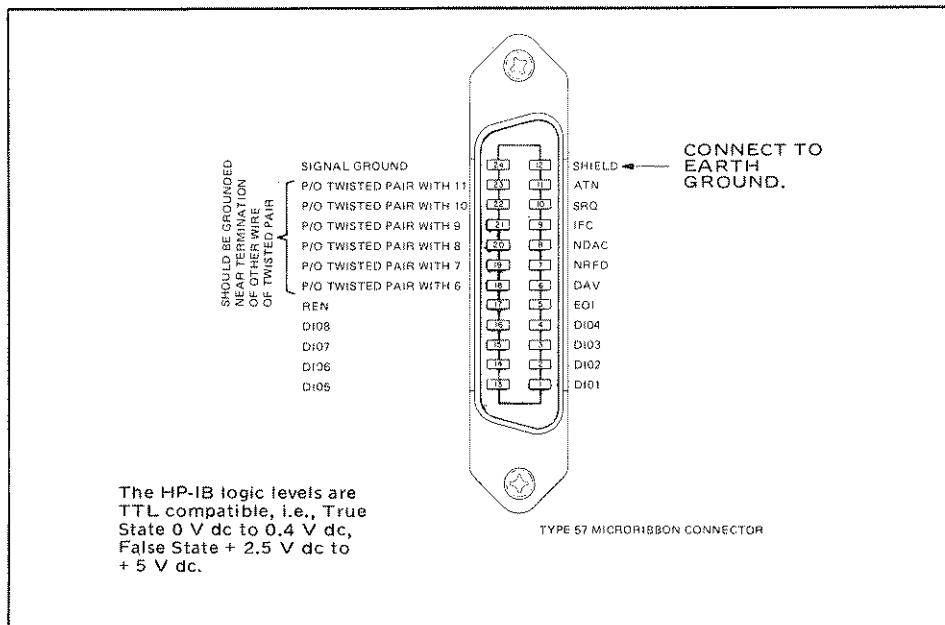

Figure 3. HP-IB Connector.

System Configurations.

HP-IB Systems can be categorized into three types:

1. Systems with no controller –

The mode of data transfer is limited to a direct transfer between one device manually set to "talk only" and one or more devices manually set to "listen only" to form a very basic fixed network system.

2. Systems with a single controller –

The modes of data transfer for these systems are:

- Direct transfer between talkers and listeners (Data Mode).*
- Transfer from a device to a controller (Data Mode).*
- Transfer from a controller to a device (Command Mode).*

3. Systems with multiple controllers –

The modes of data transfer for these systems are the same as those listed in 2. In addition a method of passing control from one controller to another is required. One controller must be designated as the system controller. The system controller is the only device that can control the HP-IB lines designated IFC (Interface Clear) and REN (Remote Enable). When the system controller sets IFC low, all I/O operations cease and all talkers, listeners and controllers are unaddressed. Control is passed to a different controller by addressing it as a talker and commanding it to "take control" (Octal code 011).

ACCEPTOR — A device receiving information on the Bus in either the Command or Data Mode (Also, see Source).

ADDRESS — A 7-bit code applied to the HP-IB in "Command Mode" which enables instruments capable of responding to listen and/or talk on the Bus.

ADDRESSED COMMANDS — These commands allow the Bus controller to initiate simultaneous actions from addressed instruments which are capable of responding.

ATN — Mnemonic (Attention) referring to the "Command Mode" of operation on the HP-IB, or the control line which places the HP-IB in this mode.

BIT — The smallest part of an HP-IB character (Byte) which contains intelligible information.

BUS COMMANDS — A group of Special Codes which initiate certain types of operation in instruments capable of responding to these codes. Each instrument on the HP-IB is designed to respond to those codes that have useful meaning to the device and ignore all others (see Table 4).

BYTE — An HP-IB character sent over the DIO lines, normally consisting of seven-bits.

COMMAND MODE — In this mode devices on the HP-IB can be addressed or unaddressed as talkers or listeners. Bus commands are also issued in this mode.

CONTROLLER — Any device on the HP-IB which is capable of setting the ATN line and addressing instruments on the Bus as talkers and listeners. (Also see System Controller.)

DEVICE CLEAR (DCL) — ASCII character "DC4" (Octal 024) which, when sent on the HP-IB will return all devices capable of responding to pre-defined states.

DATA MODE — The HP-IB is in this mode when the control line "ATN" is high (false). In this mode data or instructions are transferred between instruments on the HP-IB.

DAV — Mnemonic referring to the control line "Data Valid" on the HP-IB. This line is used in the HP-IB "Handshake" sequence.

DIO — Mnemonic referring to the eight "Data Input/Output" lines of the HP-IB.

EOI — Mnemonic referring to the control line "End or Identify" on the HP-IB. This line is used to indicate the end of a multiple byte message on the Bus. It is also used in parallel polling.

EXTENDED LISTENER — An instrument which requires two HP-IB bytes to address it as a listener. (Also see Listener.)

EXTENDED TALKER — An instrument which requires two HP-IB bytes to address it as a listener. (Also see Talker.)

GO TO LOCAL (GTL) — ASCII character "SOH" (Octal 001) which, when sent on the HP-IB, will return devices addressed to listen and capable of responding back to local control.

GROUP EXECUTE TRIGGER (GET) — ASCII character "BS" (Octal 010) which, when sent on the HP-IB, initiates simultaneous actions by devices addressed to listen and capable of responding to this command.

HANDSHAKE — Refers to the sequence of events on the HP-IB during which each data byte is transferred between addressed devices. The conditions of the HP-IB handshake sequence are as follows:

- a. **NRF**, when false, indicates that a device is ready to receive data.
- b. **DAV**, when true, indicates that data on the DIO lines is stable and available to be accepted by the receiving device.
- c. **NDAC**, when false indicates to the transmitting device that data has been accepted by the receiver.

HP-IB — An abbreviation that refers to the “Hewlett-Packard Interface Bus”.

IFC — Mnemonic referring to the Control line “Interface Clear” on the HP-IB. Only the system controller can activate this line. When IFC is set (true) all talkers and listeners on the HP-IB are unaddressed, and controllers go to the inactive state.

LISTENER — A device which has been addressed to receive data or instructions from other instruments on the HP-IB. (Also see Extended Listener.)

LOCAL LOCKOUT — ASCII character “DC1” (Octal 021) which, when sent on the HP-IB, disables the front panel controls of responding devices.

NDAC — Mnemonic referring to the control line “Data Not Accepted” on the HP-IB. This line is used in the “Handshake” sequence.

NRF — Mnemonic referring to the control line “Not Ready For Data” on the HP-IB. This line is used in the HP-IB “Handshake” sequence.

PARALLEL POLLING — A method of simultaneously checking status on up to eight instruments on the HP-IB. Each instrument is assigned a DIO line with which to indicate whether it requested service or not.

PRIMARY COMMANDS — The group of ASCII characters which are typically used on the HP-IB (see Table 5).

REN — Mnemonic referring to the control line “Remote Enable” on the HP-IB. This line is used to enable Bus compatible instruments to respond to commands from the controller or another talker. It can be issued only by the system controller.

SECONDARY COMMANDS — The group of ASCII characters which are used to increase the address length of extended talkers and listeners to two bytes.

SELECTIVE DEVICE CLEAR — ASCII character “EOT” (Octal 004) which, when sent on the HP-IB, returns addressed devices capable of responding to a predetermined state.

SERIAL POLLING — The method of sequentially determining which device connected to the HP-IB has requested service. Only one instrument is checked at a time.

SERIAL POLL DISABLE (SPD) — ASCII character “EM” (Octal 031) which, when sent on the HP-IB, will cause the Bus to go out of serial poll mode.

SOURCE — A device transmitting information on the Bus in either the Command or Data Mode (also see Acceptor).

HP-IB

SRQ – Mnemonic referring to the control line “Service Request” on the HP-IB. This line is set low (true) by any instrument requesting service.

SYSTEM CONTROLLER – This is an instrument on the HP-IB which has all the features of a standard controller with the added ability to control the IFC and REN lines. (Also see Controller.)

TALKER – A device that has been addressed to transmit data on the HP-IB. (Also see Extended Talker.)

UNADDRESS COMMANDS – These commands are obeyed by all addressable devices. This category consists of the Unlisten Command (?) and the Untalk Command (-). When the Unlisten Command (?) is transmitted on the HP-IB, all devices on the Bus will be unaddressed as listeners. When the Untalk Command (-) is transmitted, all devices will be unaddressed as talkers.

UNIVERSAL COMMANDS – These commands affect every device capable of responding on the HP-IB, regardless of whether they have been addressed or not; e.g., Serial Poll Enable (SPE) and Serial Poll Disable (SPD).

UNLISTEN COMMAND – See “UNADDRESS COMMANDS”.

UNTALK COMMAND – See “UNADDRESS COMMANDS”.

APPENDIX C

CONDENSED DESCRIPTION OF META MESSAGES AS THEY APPLY TO THE 3582A

MESSAGE CONCEPTS.

Devices which communicate along the interface bus are transferring quantities of information from one device to one or more other devices. These quantities of information are called messages. Most of the messages consist of two basic parts—the address portion specified by the controller and the information that comprises the message. In turn, the messages can be classified into twelve types. The twelve types of messages are defined in Table C-1.

Table C-1. Definition of Meta Messages.

Message	Definition
DATA	The actual information (binary bytes) which is sent from a talker to one or more listeners. The information or data can be in a numeric form or a string of characters.
TRIGGER	The trigger message causes the listening device(s) to perform a device-dependent action.
CLEAR	A clear message will cause a device(s) to return to a pre-defined device-dependent state.
REMOTE	The remote message causes the listening device(s) to switch from local front panel control, to remote program control. This message remains in effect so that devices subsequently addressed to listen will go into remote operation.
LOCAL	This message clears the remote message from the listening device(s) and returns the device(s) to local front panel control.
LOCAL LOCKOUT	The local lockout message is implemented to prevent the device operator from manually inhibiting remote program control.
CLEAR LOCKOUT AND SET LOCAL	This message causes all devices to be removed from the local lockout mode and revert to local. It will also clear the remote message for all devices.

Table C-1. Definition of Meta Messages (Cont'd).

REQUIRE SERVICE	A device can send this message at any time to signify that it needs some type of interaction with the controller. The message is cleared by the device's status byte message if it no longer requires service.
STATUS BYTE	A byte that represents the status of a single device. One bit indicates whether the device sent the required service message and the remaining 7 bits indicate operational conditions defined by the device. This byte is sent from the talking device in response to a "Serial Poll" operation performed by a controller.
STATUS BIT	<p>A byte that represents the operational conditions of a group of devices on the bus. Each device responds on a particular bit of the byte thus identifying a device dependent condition. This bit is typically sent by devices in response to a parallel poll operation.</p> <p>The status bit message can also be used by a controller to specify the particular bit and logic level that a device will respond with when a parallel poll operation is performed. Thus more than one device may respond on the same bit.</p>
PASS CONTROL	This message transfers the bus management responsibilities from the active controller to another controller.
ABORT	The system controller sends the abort message to unconditionally assume control of the bus from the active controller. The message will terminate all bus communications but does not implement the clear message.

INSTRUMENT RESPONSE TO MESSAGES.

Table C-2 indicates the messages and required bus actions which the 3582A is capable of implementing.

HP-IB WORKSHEET.

The HP-IB Worksheet provided in the back of this appendix and Table C-3 can be used to determine the capabilities of this instrument and other instruments participating in the HP-IB System. The sheet should be filled in with message applicability for the controller and each HP-IB device. When the sheet has been completely filled out, the system HP-IB Capabilities will be defined for the system.

HP-IB ADDRESSING.

Certain Meta Messages require that a specific listener and talker be designated on the bus. Each instrument on the bus has its own distinctive listen and talk address. The device address provides the identity to distinguish it from other devices on the bus. The instrument receives programming instructions when addressed to listen. When addressed to talk, the in-

Table C-2. 3582A Implementation of Messages.

Message	Implementation	Interface Functions**		3582A Response
		Sender	Receiver	
DATA	SR	T,SH	L ⁿ ,AH	Send or receive data as instructed
TRIGGER CLEAR	NA			
	R	ID-LIST C,SH	DC ⁿ ,L,AH	Performs the same function as the "reset" button on the front panel.
REMOTE	R	REMOTE ENABLE ID LIST,C _s ,SH	RL ⁿ ,L,AH RL,AH	Goes to remote. Can be set to local by local key.
LOCAL	R	C _s ,SH	RL ⁿ ,AH	Goes to local.
LOCAL LOCKOUT	R	C,SH	RL,AH	Goes to remote. Cannot be set to local by local key.
CLEAR LOCKOUT and SET LOCAL	R	C,SH,C _s	RL	Goes to local from local lockout.
REQUIRE SERVICE	S		C	Set SRQ true.
STATUS BYTE	NA			
STATUS BIT	NA			
PASS CONTROL	NA			
ABORT	NA			

*
 S = Send Only
 R = Receive Only
 SR = Send and Receive
 NA = Not Applicable

**
 SH = Source Handshake
 AH = Acceptor Handshake
 T = Talker
 L = Listener
 SR = Service Request
 RL = Remote/Local
 PP = Parallel Poll
 DC = Device Clear
 DT = Device Trigger
 C = Any Controller
 C_n = A Specific Controller(i.e., CA, CB, -)
 C_s = System Controller
 Xⁿ = Indicates Replication n Times

strument can output measurement data or send programming instructions if it is also the system controller. The address is set via jumpers or switches. Refer to Table C-3 for the allowable program codes.

Table C-3. Address Selection.

ASCII Code Character		Address Switches					5-bit Decimal Code
Listen	Talk	A5	A4	A3	A2	A1	
SP	@	0	0	0	0	0	00
!	A	0	0	0	0	1	01
"	B	0	0	0	1	0	02
#	C	0	0	0	1	1	03
\$	D	0	0	1	0	0	04
%	E	0	0	1	0	1	05
&	F	0	0	1	1	0	06
'	G	0	0	1	1	1	07
(H	0	1	0	0	0	08
)	I	0	1	0	0	1	09
*	J	0	1	0	1	0	10
+	K	0	1	0	1	1	11
,	L	0	1	1	0	0	12
-	M	0	1	1	0	1	13
.	N	0	1	1	1	0	14
/	O	0	1	1	1	1	15
0	P	1	0	0	0	0	16
1	Q	1	0	0	0	1	17
2	R	1	0	0	1	0	18
3	S	1	0	0	1	1	19
4	T	1	0	1	0	0	20
5	U	1	0	1	0	1	21
6	V	1	0	1	1	0	22
7	W	1	0	1	1	1	23
8	X	1	1	0	0	0	24
9	Y	1	1	0	0	1	25
:	Z	1	1	0	1	0	26
;	[1	1	0	1	1	27
<	\	1	1	1	0	0	28
=]	1	1	1	0	1	29
>	~	1	1	1	1	0	30

Since each instrument has its own distinctive address, HP-IB programming requires that an address be designated when attempting to send information to, or receive information from, an individual instrument. An address is usually in the form of:

universal unlisten, device talk, device listen

The universal unlisten command removes all listeners from the bus, thus allowing only the specific listener(s) designated by the device listen parameter, to receive information. The information is sent by a talker which is designated by the device talk parameter. In many controllers this type of basic bus addressing is taken care of automatically.

INSTRUMENT PROGRAMMING.

The Instrument Programming section provides the basic information and programming techniques to control the -hp- 3582A via Remote programming. The first and most important step for the user is to completely define the measurement the instrument will be making. The next step is to define the measurement requirements in terms the instrument can use. These terms are called Program Codes. They are device-dependent since each instrument has its own set of Program Codes. The Program Codes are ASCII characters which are transmitted to the instrument via the HP-IB.

The final step is to write the problem and solution down in the order it should be performed in (an algorithm) and then convert the Algorithm into controller language.

Once the algorithm for the program has been completed, it can be converted to code. The conversion to code requires the conversion charts or block diagram for Meta Messages as mentioned before, plus the understanding of the instrument program codes.

NOTE

The Meta Message in itself is not a program code or an HP-IB command. It is only intended to be an uncomplicated means to translate a program written as an algorithm into the controller's code.

For detailed controller/instrument programming codes, refer to the Operating Notes on the specific controller (-hp- XXXX). These Operating Notes are available from your local -hp- Sales and Service Office.

The Meta Message Block diagrams show which bus signals are required for a particular message. Note that some controllers may be able to implement the function with a single character or code or it may take several lines of code.

ALGORITHM.

The Algorithm written for the instrument will express exactly how to set up and implement the instrument measurement or function. In order to make the transition from algorithm to program code as simple as possible, the user should use the twelve Meta Messages as key words.

These Messages may be directly converted to code using an -hp- calculator manual. The -hp- 9825A Calculator Extended I/O Manual provides a one-to-one chart for program code conversion. In cases where the controller used with the instrument does not have a conversion chart, the user may refer to the block diagram associated with each Meta Message located in the expanded Meta Message topic. The block diagrams show the bus signals required to implement each message. Note that this is only required when a conversion chart is not available.

An example application and program algorithm using an -hp- 3582A instrument and the Meta Messages is shown below. Note that the algorithm emphasizes the key words and does not employ any code. The application problem the algorithm is written for can be described as:

A system employing a single controller and three instruments consisting of an Analyzer, scanner, and printer are to measure the outputs of ten relays. The ten relays should close singly and then remain closed so that at the end of the measurement sequence all ten relays are closed.

The program should print out the reading after the measurement cycle is complete. The program should also completely abort operations if there is a problem with the Analyzer. If the Scanner errors, the controller should generate an error message to the printer.

1. ABORT all previous operations.
2. Set the Analyzer to REMOTE.
3. LOCAL LOCKOUT the Analyzer.

4. Send DATA to configure the Analyzer to:
 PRESET
 NON-REPETITIVE
 MARKER ON, MARKER POSITION
5. Send DATA to Scanner in order to close relay 1.
6. Send DATA to configure the Printer to:
 Begin printing at top of page
 2" width of printing
 Characters ¼ standard size
7. Send DATA to ARM the trigger in the Analyzer.
8. Send the DATA measurement to the controller and store in an array.
9. Send DATA to Scanner to increment the relay closure by 1.
10. Check Analyzer and Scanner to see if they REQUIRE SERVICE.
11. If REQUIRE SERVICE, check STATUS BYTE; otherwise skip next step.
12. If Analyzer sent SRQ indicating it did REQUIRE SERVICE, end program;
 otherwise send DATA to the Printer to indicate an error in the Scanner.
13. Return to ARM step and continue incrementing the relay closure until all 10
 relays have been measured.
14. Send the DATA array to Printer for printout.
15. CLEAR LOCKOUT and SET LOCAL.
16. End program.

EXAMPLE PROGRAM WITH CODE.

The example Algorithm is implemented by this means:

- a. HP-IB Format Only
- b. 9825A controller syntax

In all three cases the numbers will directly correspond to each other. The Algorithm describes a single measurement made by the Analyzer using the Scanner as a source.

- a. Send DATA to the Scanner to close relay 1.
- b. Send DATA to configure the Analyzer to:
 Preset
 Non-Repetitive
 Marker on
 Marker location
- c. Arm the Analyzer and prepare it to transfer the Marker amplitude and frequency by
 sending DATA characters "AR", "LMK".
- d. Send the DATA from the Analyzer to the Calculator.

<u>Program (talk, listen)</u>	<u>Select Code</u>
Address U,5 Calculator -	
K, + Analyzer -	711
/ Scanner -	709

HP-IB FORMAT

Command Mode

Data Mode

- | | |
|--------|------------------------------|
| 1. ?U1 | CI |
| 2. ?U+ | “PRE”, “RP0”, “MN1”, “MP120” |
| 3. ?U+ | “AR”, “LMK” |
| 4. ?VK | ±N.NNNE±NN, ±NNNNN.NNN |

9825A CALCULATOR FORMAT

1. fmt f; wrt 709, “CI”
2. wrt 711, “PRERP0MN1MP120”
3. wrt 711, “AR”, “LMK”
4. fmt e.3, f.3; red 711, A,B

NOTE

In this example, only the DATA Message is implemented. The DATA message is implemented each time a character or group of characters is transmitted over the HP-IB.

META MESSAGES EXPANDED.

This section on Meta Messages provides an in-depth description and flowchart for implementing each specific message that pertains to the -hp- 3582A. Additional information on instrument response to the implementation of each message listed in this section is also provided where required to facilitate programming.

Figure C-1. Message List.

DATA — The DATA message is the actual information (8 bit byte) which is sent from a talker to one or more listeners. This action requires the controller to first enter the command mode to set up the talker and receiver(s) for the transfer of DATA. When the command mode is complete, the information is transmitted when the bus enters the Data Mode.

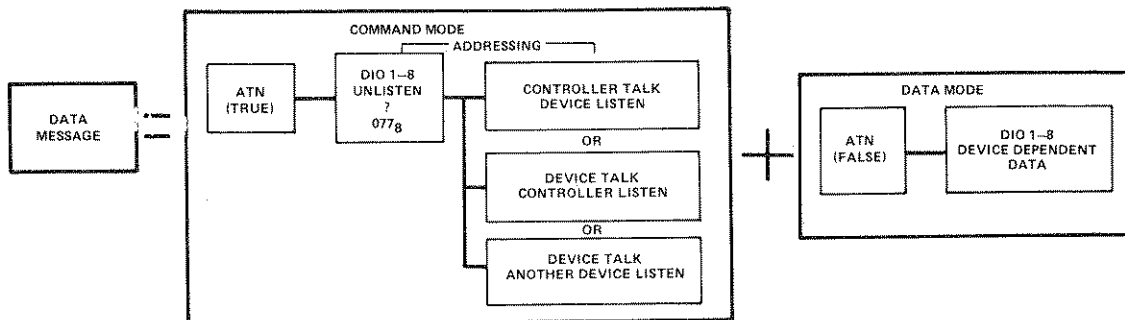
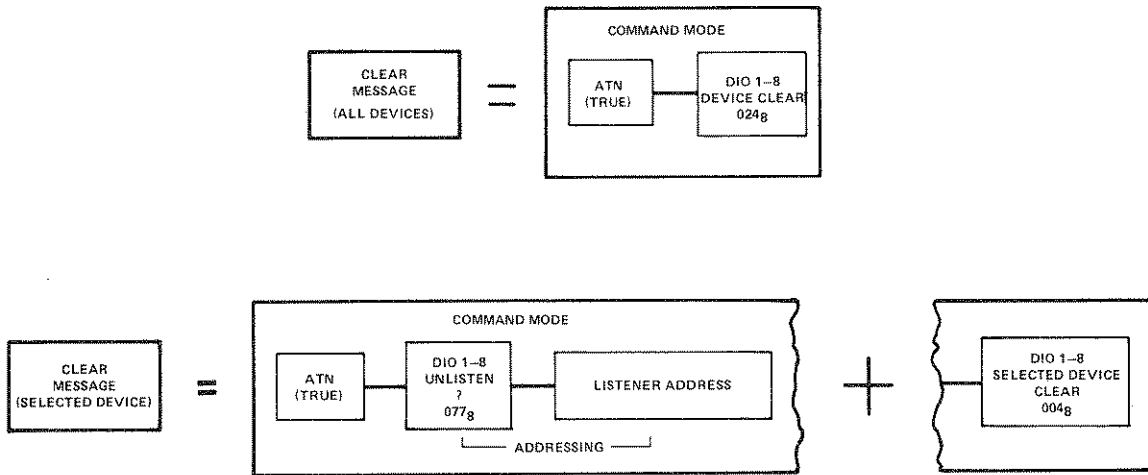
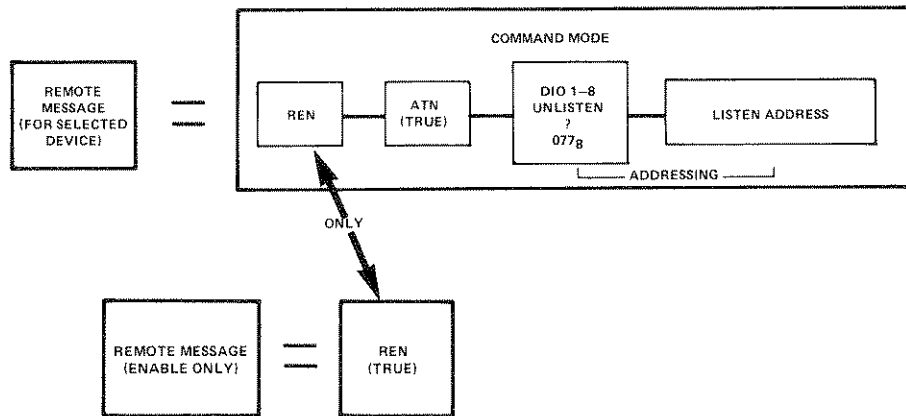

Figure C-1. Message List (Cont'd).

CLEAR – The Clear Message may be implemented for addressed devices or for all devices on the bus capable of responding. In both cases the controller places the bus in the Command Mode to execute the message.



REMOTE – Only the System controller can place the instrument into the Remote Operating condition. To implement the Remote message, the controller will set the REN line true. The HP-IB is then the Enable-Only mode. In the Enable-Only mode, the bus instruments are not in remote but will go into Remote as soon as they are addressed.



LOCAL – The Local Message will remote addressed instruments from remote Operation mode to Local-Front panel control. The controller must place the HP-IB into the command Mode and address all instruments to listen that are to be returned to local. The local message will not remove the bus from the remote mode, only the listening devices.

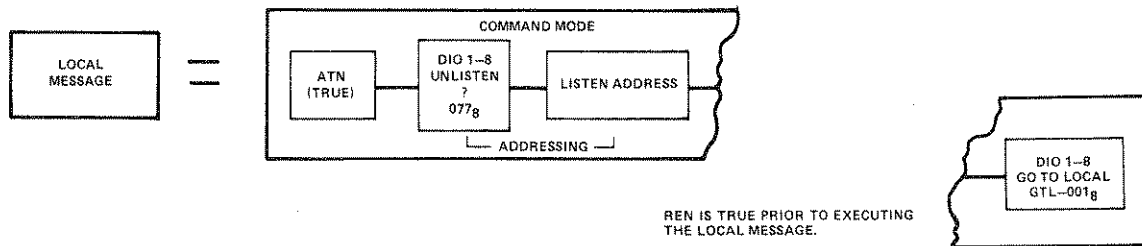
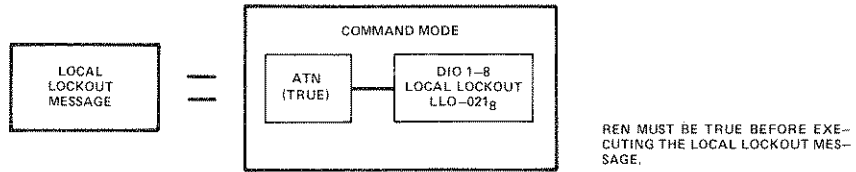
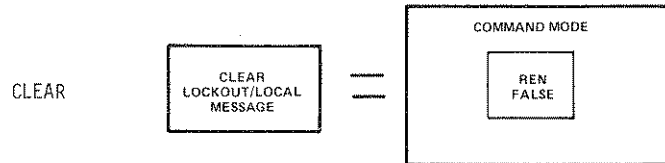

Figure C-1. Message List (Cont'd).

LOCAL LOCKOUT – The Local Lockout Message prevents the instrument operator from placing the instrument into local control from the front panel. The controller must be in the command mode to send the local lockout message.



LOCKOUT AND SET LOCAL – When implemented, this message removes all instruments from the local lockout mode and causes them to revert to local-front panel control. Since the REN line is set false the bus is also in the local mode.



REQUIRE SERVICE – The Require Service Message is implemented by an instrument by causing the HP-IB SRQ line true state. The Require Service message and therefore the SRQ line is held true until a poll is conducted to determine the cause of the request for service or until the device no longer needs service.



*REFER TO THE STATUS BYTE MESSAGE FOR THE SPECIFICATIONS REQUIRED TO FORCE SRQ FALSE.

MESSAGE	HP-IB IMPLEMENTATION WORKSHEET											
	DEVICE					DEVICE						
	MODEL	LISTEN	TALK	5 BIT VALUE	MODEL	LISTEN	TALK	5 BIT VALUE	MODEL	LISTEN	TALK	5 BIT VALUE
INSTRUMENT IDENTIFICATION AND HP-IB ADDRESS												
DATA												
TRIGGER												
CLEAR												
LOCAL												
REMOTE												
LOCAL LOCKOUT												
CLEAR LO & SET LOCKOUT												
REQUIRE SERVICE												
STATUS BYTE												
STATUS BIT												
PASS CONTROL												
ABORT												

S = SEND ONLY R = RECEIVE ONLY S & R = SEND AND RECEIVE N = NOT IMPLEMENTED

**APPENDIX D
APPLICATION NOTES**

SIGNAL AVERAGING WITH THE HP 3582A SPECTRUM ANALYZER

AN 245-1

**MEASURING THE COHERENCE FUNCTION WITH THE
HP 3582A SPECTRUM ANALYZER**

AN 245-2



SIGNAL AVERAGING WITH THE HP 3582A SPECTRUM ANALYZER

AN 245-1

FOREWORD

Low frequency spectrum analyzers are fast turning into digital instruments. A primary reason for this trend is the frequency analysis speed achieved through the startlingly efficient Fast Fourier Transform computing algorithm. With the additional help of large-scale integrated circuits, compact low-frequency analyzers are emerging which are often 10 to 100 times faster than traditional swept-tuned-filter spectrum analyzers. The HP 3582A is a low-frequency analyzer which continues in a long historical line of HP wave and spectrum analyzers. However, it is totally digital except for input filtering and cathode ray display.

The purpose of this application note is to develop an understanding, by theory and example, of two kinds of signal averaging commonly used in digital signal analysis of the kind employed by the 3582A. These averaging

routines are called "power spectrum averaging" and "time averaging." The corresponding swept analyzer techniques are video filtering (for smoothing measurements of random signals) and narrow-band analysis (when used to enhance signal-to-noise ratios). Two other related digital techniques are discussed which do not have direct equivalents in swept analyzers. These are signal-to-noise enhancement of recurrent transients and a peak-hold feature.

This application note is largely tutorial because of our belief that, while many readers will not have had experience in the area of digital signal processing, all will want a basic understanding of certain of its ideas in order to get maximum benefit from an instrument like the 3582A. This note and others in the series are intended to help provide this understanding.

THE HEWLETT-PACKARD MODEL 3582A SPECTRUM ANALYZER

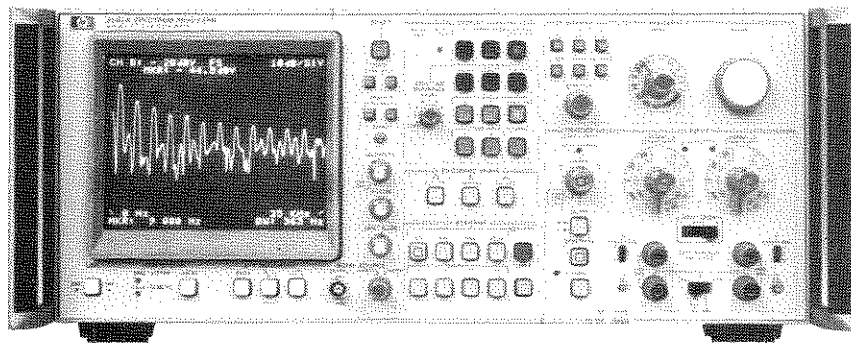

The HP 3582A is a spectrum analyzer covering the frequency range of DC to 25 kHz. Although it is a FFT-based, digital instrument, a special design effort has made it as straightforward to use as a conventional swept analyzer. With dual measurement channels it is possible to measure transfer function gain and phase, as well as the coherence function. A built-in random or pseudo-ran-

dom noise source, whose spectrum tracks the analysis range, is a useful measurement stimulus. Band Selectable Analysis enables narrowband, high resolution analysis to be applied to any portion of the frequency range. The instrument comes equipped with a flexible HP-IB interface for control and two-way data transfers.

TABLE OF CONTENTS

SECTION		PAGE
1	The reasons for signal averaging Deterministic and random signals Classes of random signals The kinds of signals which benefit from signal averaging are defined and discussed.	1
2	The spectrum of a random process Some properties of a random process Analyzing a random process with the FFT Certain properties of random spectra influence the way measurements are made. In addition, the FFT of a random process has some intrinsic limitations which are overcome by averaging.	2
3	Power spectrum averaging Power spectrum averaging compared with video filtering This is a light treatment of the origin of power spectrum averaging, and a discussion of the analogy between this and video filtering.	3
4	Time averaging When to use time averaging How it works There is another kind of averaging which can be used whenever a synchronizing signal is available.	4
5	Summary of averaging properties Power spectrum averages Time averages This is a tabular summary of the principle features of both power spectrum and time averaging.	5
6	Characteristics of 3582A averaging routines Power spectrum averaging; Exponential averaging Time averaging Peak "averaging" The way signal averaging is carried out in the 3582A is explained, along with a couple of related techniques also available in the analyzer.	6
7	Examples Two power (RMS) averaging examples Two time averaging examples Peak averaging example Here are some documented experiments designed to illustrate each of the 3582A averaging techniques.	7
	Appendix 1: Probability distributions of power spectrum estimates Gaussian random processes The averaged power spectrum as a random process	12
	Appendix 2: 90% confidence limits for power averages	
	Bibliography	

SECTION 1:

The reasons for signal averaging

Deterministic and random signals. A deterministic waveform, or signal, is one which can be described by an explicit mathematical function of time. Deterministic signals are easy to visualize: sinusoids and pulse trains are good examples.

Signals derived from real, physical processes are not often deterministic. More likely they are random, or a mixture of deterministic and random. One good reason for this state of affairs is succinctly stated by Shannon's information theory: deterministic signals are not information-bearing, since they are predictable. Some common examples of real-world signals which are more or less random are speech, music, digital data, seismic data, and mechanical vibrations.

Classes of random signals. The technical term used to describe a signal which is a random function of time is "random process." Two useful classes of random processes are:

- a. Pure random process: a signal with no deterministic portion. An example is the sound emitted by a compressed gas escaping from a nozzle.
- b. Mixed random process: a composite signal, the sum of a pure random process and a deterministic signal. For instance, the output of a noisy amplifier with a sinewave input is a mixed random process.

An example of each of these is shown in Figure 1.

Measuring the frequency spectra of random processes involves some difficulties not encountered in measuring deterministic signals. The source of the difficulties is discussed in the next section. **The purpose of signal averaging techniques is to improve the measurement and analysis of random processes.**

Figure 1.

Typical random processes

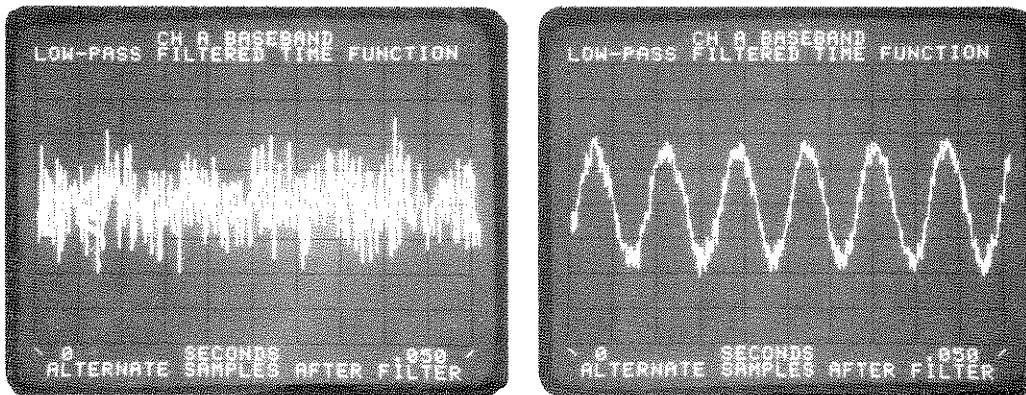

a. Pure random process

b. Mixed random process

Each of the examples shown is a 50-millisecond segment of a process which, theoretically, continues for all time.

SECTION 2:

The spectrum of a random process

Although the exact time waveform of a random process cannot be described by an explicit mathematical function of time, there are certain ways to describe a random process which are explicit and quantitative. Among these ways are the probability density function, the auto-correlation function, and the power spectrum. These parameters provide valuable information about the process, and instruments are available to measure these (and other) parameters of any particular random process. In this note, we are concerned with the measurement of the parameter called the power spectrum. (The 3582A actually displays the square root of the power spectrum, called the amplitude spectrum.)

Some properties of the spectrum of a random process:

- a. **The spectrum is a continuous function of frequency.** This follows from the fact that a random process is not periodic.
- b. **The phase of the linear spectrum of a random process is a random function of frequency.** For this reason, a phaseless spectrum, called the power spectrum, is generally used to describe random processes. This is the same as the magnitude-squared spectrum, obtained by multiplying the linear spectrum by its complex conjugate. Sometimes the square root of the power spectrum is used, as in the 3582A.
- c. **Each segment of the infinite-duration time waveform, being different from any other segment, makes a unique contribution to the spectrum.** Thus, the spectrum resulting from any finite-time measurement is only an approximation to the true spectrum of the random process.

In this last property is found the primary difficulty in measuring the spectrum of a random process. Because we are limited to making finite-time measurements, **the spectrum calculated from one finite segment of the random process only approximates the true spectrum.** It follows that the spectrum derived from one time segment will differ from that of the next, and so on. How inaccurate is such a single measurement? How can we increase the accuracy of measuring the power spectrum? These questions will be taken up next.

Analyzing a random process with the FFT.

The Discrete Fourier Transform, in the form of the Fast Fourier Transform (FFT) implementation, translates a finite segment of discrete time data into a discrete frequency spectrum. For instance, the 3582A operates (in single-channel mode) by sampling the signal on its input terminals to produce 1024 binary numbers representing a segment of the input time function. These numbers are transformed by the FFT into 512 complex values in the frequency domain. Because of possible aliasing, only 256 of these are used. The amplitude display consists of 256 connected points representing the numerical contents of 256 data storage locations called "bins." The numbers in the bins are calculated from the FFT output and can represent either spectrum magnitude or log magnitude.

What if the input time signal is a random process? A common example of this is a Gaussian process. In this case, the magnitude spectrum turns out to be 256 independent random variables with Rayleigh distribution (see appendix). It can be shown that the standard deviation of each bin's contents is about the same as the true value being measured. This obviously poor measurement is inherent in the FFT, regardless of the number of points in the transform. Figure 2 illustrates this with a white noise source as the Gaussian process.

Figure 2.

The spectrum of a 10-millisecond segment of a Gaussian random process

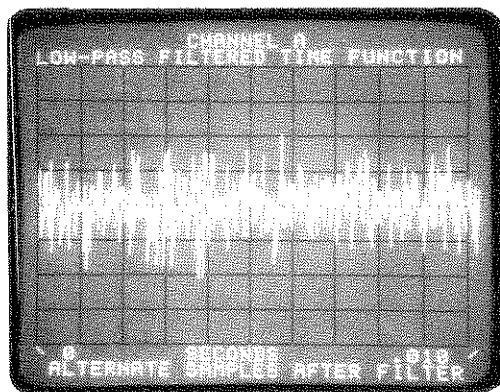

display of the sampled time waveform

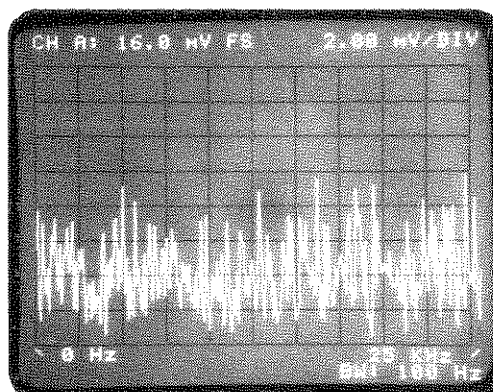

linear magnitude spectrum

↑ standard deviation
of a single transform
↓ true mean value of
entire process

SECTION 3:

Power spectrum averaging

If we watch a particular bin while the 3582A analyzes successive segments of a random process, we will begin to suspect that there is a way to improve the measurement accuracy. While there is considerable variation among the values of amplitude, there appears to be a central tendency (or mean value) for the data. More exactly, if we take K measured values and calculate their average (mean), and then repeat this several times, we will have a collection of numbers (the individual averages) whose variance is considerably less than that of the individual data points. Or, putting it another way, the average of K independent measurements is a better statistical "estimator" of the true magnitude of a bin than any single measurement. The accuracy of the average improves (in the sense that the variance decreases) as K gets larger. This kind of average is called a power average, since it is derived from a series of power spectra.

Since employing large values of K can be very time-consuming, especially in narrow-band analysis, it is necessary to know what accuracy to expect for a given value of K . In dealing with random data, a useful form in which to present such accuracy specifications is the "confidence interval." This is a chart or table listing a numerical interval to be attached to a measured value. With a given confidence, the true value can be stated to be within the interval. For instance, a 90% confidence table states that, in 90% of the measurements, the true value will lie within the interval given. Such a table and an example of its use is given in Section 4 to aid 3582A users in choosing values of K appropriate to their accuracy needs.

Power spectrum averaging compared with video filtering. Many readers will have had experience with conventional swept spectrum analyzers. In these instruments, post-detection low-pass filtering (video filtering) is provided to smooth the measurement of random process spectra. As it happens, this technique is directly related to power averaging in digital analysis, and it is interesting to examine the relationship briefly.

Conventional analyzers: Assume the input to the analyzer is a random process whose power spectrum is nearly constant across the analyzer bandwidth (this assumption is necessary so that the estimate will be "unbiased"; that is, tend in the limit to the true value of the spectrum). Then the spectrum estimate will have this statistical accuracy:

normalized std. dev. of the estimate of the amplitude spectrum =

$$\frac{1}{\sqrt{B_a T_a}}$$

where

B_a = analysis bandwidth

T_a = effective averaging time, equal to two time constants for single pole filters

Digital analyzers: Using the same assumption as above, the spectrum estimate of a single bin is:

normalized std. dev. of the estimate of the amplitude spectrum =

$$\frac{1}{\sqrt{B_a K T_d}}$$

where

B_d = bandwidth of one bin $\geq T_d$

K = number of records averaged

T_d = length of time record

Comparison: By comparing these results on the basis of equal analysis bandwidths ($B_a = B_d$), it is plain that equal averaging times ($T_a = K T_d$) produce statistically equivalent measurements of the amplitude spectrum at each frequency. **However, the N-point FFT makes N such estimates, covering a total analysis range of $N B_d$, in the same time that the conventional analyzer makes one estimate.**

SECTION 4: Time averaging

When power averaging is applied to a mixed random process, the deterministic portion of the signal is unaffected, since its variance is zero to start with. **Power averaging will smooth only the estimate of the random portion of the spectrum.** It will not, for instance, uncover the deterministic spectrum if it is "buried in the noise."

When to use time averaging. If there exists an independent signal, free from noise, which is synchronous with the periodic part of a mixed random process, then we can use another kind of averaging, called "time averaging" in the 3582A, which *will* enhance signal-to-noise ratios. Of course, the need for the synchronizing signal is rather restrictive, although there are numerous situations in which one is available. For example, in biological stimulus-response measurements, the stimulus signal itself will serve as the synchronizer while analyzing the noise-contaminated response.

How it works. The principle of time averaging is straightforward. The operation may be explained from the point of view of either time or frequency domains, although perhaps the time domain view is intuitively clearer: select K equal length intervals of a mixed random process. The intervals must be chosen so that the first point of each occurs at the same position in the cycle of the periodic component. If the corresponding points of all the intervals are added together, and then divided by K to produce an average, we can deduce the following about this averaged waveform:

- 1) The amplitude of the normalized periodic component is $(1/K)K = 1$ times the amplitude of the periodic component in one interval. This is because the synchronized components add directly.

- 2) The random components, being uncorrelated, add on an RMS basis; their normalized sum is $(1/K)\sqrt{K} = 1/\sqrt{K}$ times the amplitude of the random component in one interval.

Thus, in the average, the ratio of the periodic component to the random component is

$$\frac{1}{1/\sqrt{K}} = \sqrt{K}$$

times higher. This means a S/N improvement of $20 \log \sqrt{K} = 10 \log(K)$ dB. The maximum K is 256 in the 3582A, so the S/N improvement for time averaging approaches 24 dB.

Time averaging does *not* reduce the normalized standard deviation in measuring the random portion of the spectrum. In the averaged waveform, the ratio of the standard deviation to the mean value (of the random portion) is the same as that of a single measurement. Therefore, if one wants both improved measurement of the random portion and enhanced S/N ratio, both spectrum and time averaging should be used in succession. This is possible either for stored time data, or for signals whose statistics don't change with time. Of course, a synchronizing signal must be used for the time average.

Time averaging can also be performed on some mixed random processes whose deterministic components are not strictly periodic. This is most easily seen in the case of transient analysis in which the transient is stimulated by a non-periodic signal. It is necessary that the transient diminish to insignificance between applications of the stimulus so that the averaging process will be performed on identical samples of the deterministic signal. See Figure 3 and the example in Section 7.

Figure 3.

Time averaging on a repetitive but not periodic transient

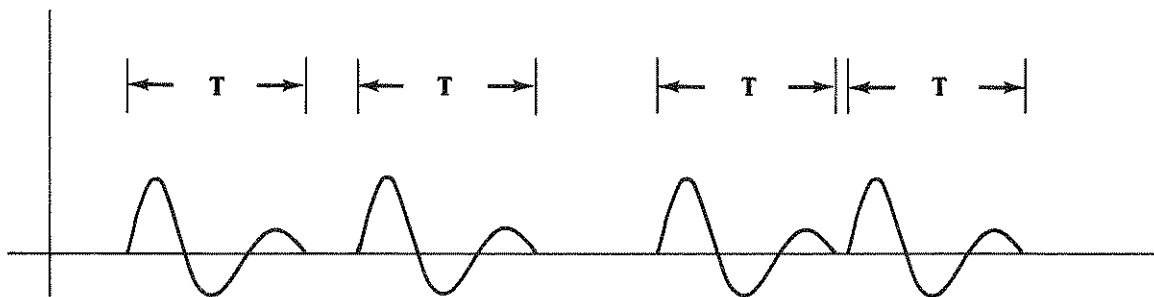

Each interval T begins at the same point in the waveform. An actual example of this is given in Section 7.

SECTION 5:

Summary of averaging properties

The important properties of the two forms of signal averaging in the 3582A are listed here in summary:

Power spectrum averaging

- a) Power averaging is applicable to either pure or mixed random processes.
- b) Power averaging reduces the inherent variance resulting when the FFT is used to determine the spectrum of a random process. Thus, a power averaged spectrum is a statistically more accurate estimate of the true spectrum.
- c) When applying power averaging to a mixed random process, the deterministic portion of the signal is unaffected. Thus, the S/N ratio (the ratio of the deterministic to the random parts of the signal) is *not* changed.
- d) No synchronizing signal is needed.
- e) Phase is not available in the power average routine. (The phase information given by the 3582A is calculated with another routine; see Section 6.)

Time averaging

- a) Time averaging is useful only with mixed random processes (the signal must have a deterministic component).
- b) Time averaging increases the ratio of the deterministic to random portions of the signal (i.e., it improves the S/N ratio).
- c) The normalized standard deviation of the random portion of the spectrum is unchanged.
- d) A synchronizing signal, in fixed relation to the deterministic portion of the signal, must be used with time averaging.
- e) In the 3582A, the results of time averaging on a signal may be displayed in both time and frequency domains.
- f) A time averaged spectrum is complex; both amplitude and phase spectra are derived from the same linear averaging algorithm.

Figure 4.

Relative weighting of spectra in exponential average routine

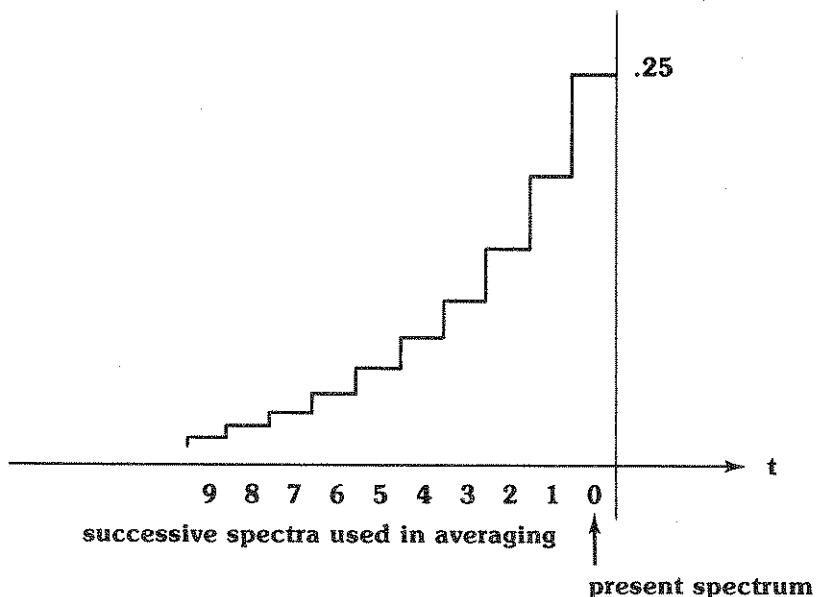

SECTION 6:

Characteristics of 3582A averaging routines

Power spectrum averaging. The 3582A computes a power average as follows: the FFT produces both a real and an imaginary spectrum component at each analysis frequency. These components are squared and added. For each successive transform, the same operation is performed, and a cumulative sum is maintained for each data bin. Thus, for a K-sized average (K is a power of 2, chosen between 4 and 256), each bin contains the sum of 2K squared values at the end of processing.

This sum is then divided by K, which converts it to the power spectral value for that bin. This process, performed independently for each of the 256 bins, generates the power spectrum average. Before display, the square root of each sum is extracted to produce the amplitude spectrum. The main reason for this step is convenience of units; for instance, volts is usually more appropriate than (volts)². Because of the square root operation, the control button which calls up this averaging routine is labeled "RMS" rather than "POWER."

With the power averaging routine, there is also available a phase display, but it is not a power-averaged quantity, since the power spectrum is phaseless. Rather, for each transform, the phase angle of each bin is computed conventionally as

$$\text{phase} = \tan^{-1} \left(\frac{\text{imaginary component}}{\text{real component}} \right)$$

and the K resulting numbers are simply averaged for the display.

While power averaging is proceeding, the user can watch the interim averages on the display. (However, the averaging process will proceed more quickly if the display is turned off, since this eliminates the need for intermediate root-taking and display formatting.) Also, if further averaging seems desirable after the K spectra are averaged, pressing a higher-numbered button will continue the process to the new value of K.

Exponential averages. Another variation of power averaging is the "moving" or exponential average. As the name suggests, this form of average gives more weight to the most recent measurements. In the 3582A, moving averages are calculated by weighing the latest spectrum by 1/4 and adding it to the previous average, weighted by 3/4. The result is that the Mth spectrum before the present one is given the weight $1/4(3/4)^M$. The standard deviation of an estimate from this averaging routine is about 8 dB less than a single FFT spectrum estimate. The weighting function is shown in Figure 4.

Moving averages are especially useful in cases where the random process is not stationary; that is, when the mean and/or variance of the random process changes with time.

Time averaging. The 3582A computes this type of average as follows: K successive, *synchronized* time records are added, and the sum is divided by K (K is chosen as a power of 2 from 4 to 256). The result is the time domain average. Both the time average and its transform are available for display, so that the result of the S/N enhancement may be observed in either time or frequency domains.

Two methods are available for applying the necessary synchronizing (triggering) signal used with time averaging:

- a) Internal triggering. The trigger signal is applied to Channel A, using the polarity and level controls to establish reliable triggering. (The internal trigger circuitry is only connected to Channel A.) Then the signal to be averaged is connected to Channel B.
- b) External triggering. The TTL-compatible trigger signal is applied to the rear panel connector, and the adjacent switch is set to "ext. trig." Then any combination of channels may be used for the signal(s) to be averaged.

Time averaging is a relatively fast procedure, requiring only slightly more time than that necessary to acquire the K time records. This is because only one FFT operation is performed, rather than K, as in the case of power averaging. (In the 3582A an FFT takes about 350 milliseconds.)

There is no exponential (moving) average routine for the time average procedure. Attempting this causes an error message to be displayed on the CRT.

Peak "averaging." This procedure is not truly averaging, but rather a peak holding process: K transforms are made (K is 4, 8, . . . , 256), and each set of data is compared, bin for bin, with the previous set. The larger number is then retained, with the result that, at the end of the procedure, each bin contains the largest data value encountered during the processing of the K signal segments.

Applications include noise monitoring, measurement of frequency drift, and the like. If continuous monitoring is wanted (that is, no limit on the size of K), pressing the "EXP" key will cause peak averaging to continue indefinitely.

SECTION 7:

Examples

In this section we have included the results of several actual measurements using the 3582A. These were chosen in order to illustrate the material discussed so far, and enough information is included to enable the reader to try similar experiments if he chooses. Each example includes a measurement block diagram and photos of the 3582A display screen, as well as relevant control settings and discussion.

Examples of RMS (power) averages. In Section 3 we stated that averaging a number of FFT spectra of a random process gives an estimate of the true spectrum which is more accurate than any single transform. Figure 5 illustrates this point. The signal being analyzed is a random binary data stream, whose transitions are clocked at a 1-kHz rate. A 50-bit segment of the signal is

shown in (a), along with the Fourier transform of the segment. Although the spectrum is an accurate frequency domain representation of that *particular* sample of the entire signal, one sample alone gives a poor and misleading indication of the characteristics of the whole process. A much better estimate of the spectrum of the process is shown by the power average of 64 spectra, in (b).

The control settings can generally be inferred from the self-documenting display. Other data of interest are:

- The Hanning passband was used for good resolution.
- For the single sample, the REPETITIVE button was out (off) and a single record was captured by pressing ARM.

Figure 5.

Synchronous binary data

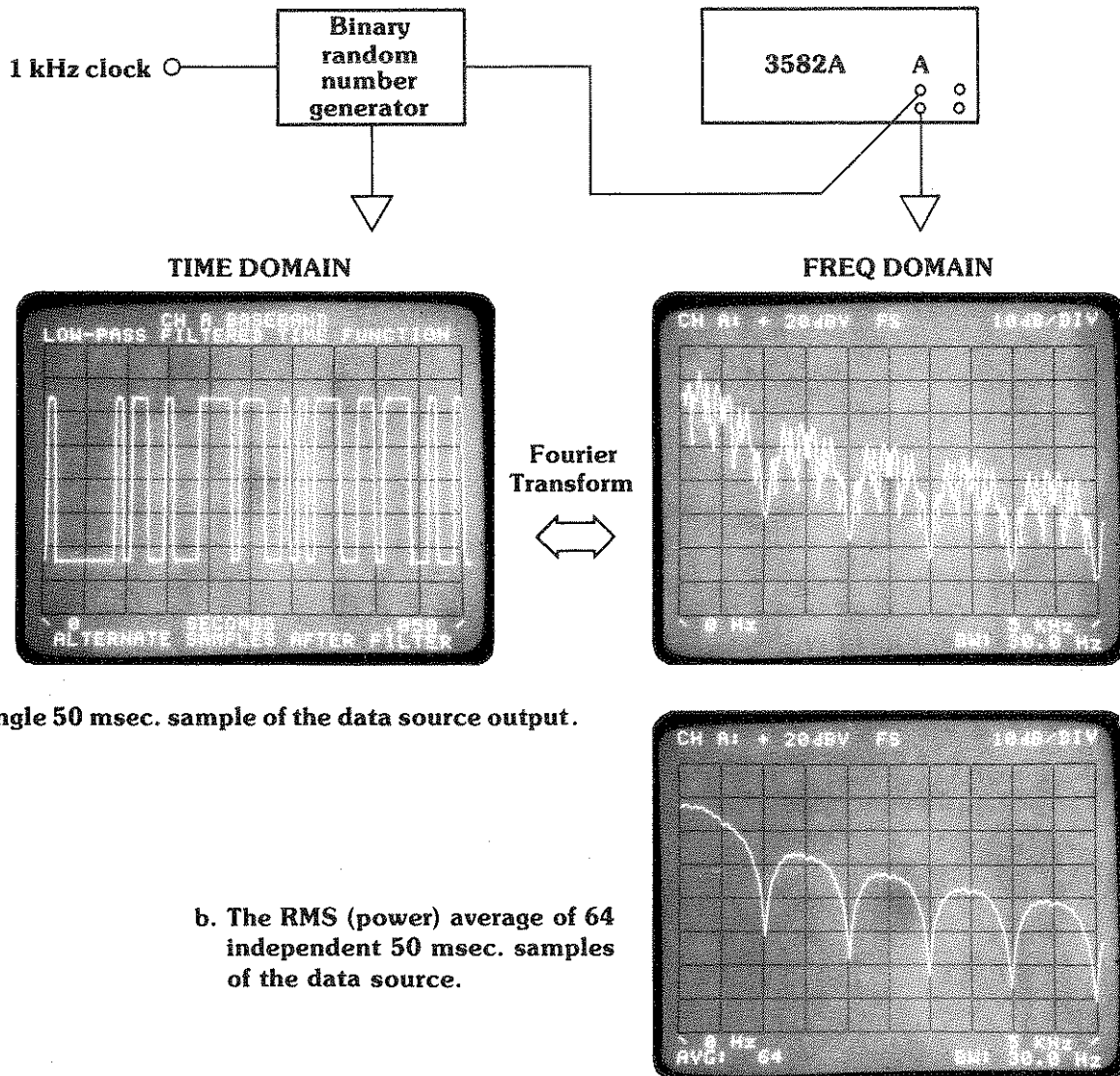

Another power averaging example.

There are some random processes whose statistics vary considerably over short intervals of time, but which are more stable (statistically "stationary") in the long run. Human speech is a good example. In the experiment of Figure 6, the object was to determine quantitative spectral differences between adult male and female voices. A common-speech script was chosen, which each speaker read for about two minutes, enough time to process 256 spectra. The individual spectra varied widely; some corresponded to time segments between words and had little energy. After 40 or 50 spectra were averaged, however, the long-term trends became evident. Several 256-spectrum averages from the same speaker showed differences of less than 3 dB.

In performing the experiment, the first step was to acquire and process the time records from the first speaker. After completing the RMS averaging, the display amplitude reference level was shifted 30 dB higher

(to separate this data from the next, when displayed simultaneously) and then stored in TRACE 1. The second speaker's voice was then averaged in the same way. When this was completed, the two traces were displayed together for comparison. Hanning passband shape was used throughout the experiment.

Examples of time averaging. As we discussed in Sections 1 and 2, a principal feature of time averaging is the use of a synchronizing signal to insure that each time record used in the average contains the deterministic waveform in the same relative position.

Figure 7 is the block diagram and measurement results showing how a signal can be extracted from noise by this technique. Since Channel A in the 3582A is the only one from which an internal trigger may be derived, it is used in this experiment to trigger the data acquisition. The analysis is carried out in Channel B, to which the noisy signal is connected.

Figure 6.

Human voice spectrum

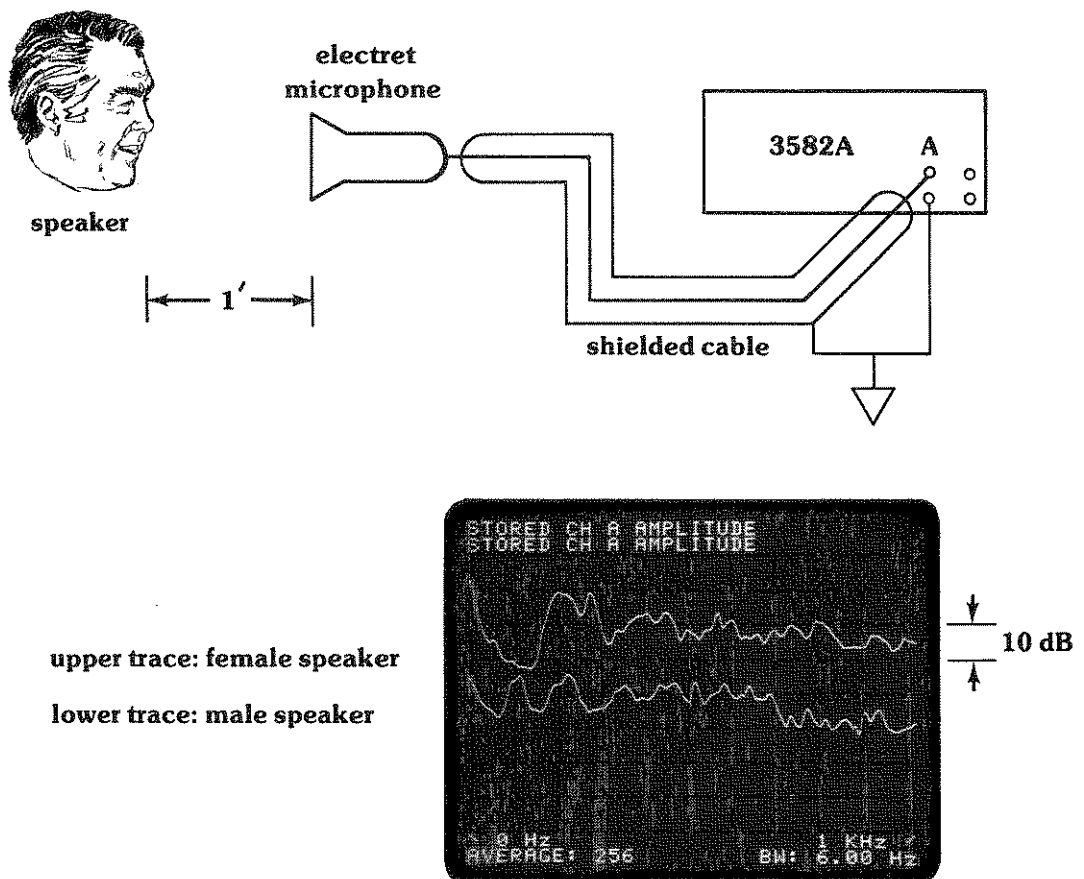

traces were separated 30 dB for clarity

The procedure followed was:

- a) Set up the controls as follows:
 Display: Amplitude A, 10 dB/div, ref. level normal
 Passband shape: Hanning
 Average: off
 Marker: off
 Span: 0-25 kHz
 Trigger: + slope, repetitive
 Input: A, AC coupling A & B
- b) Connect the pure squarewave to A. Holding in the Time A button, adjust Channel A Sensitivity for about half scale display. Then adjust Trigger level for reliable sync.
- c) Switch display and input mode to B. Connect

- d) the noisy signal to Channel B. Adjust B Sensitivity as in (b).
- e) At this point, the single record photographs were made by momentarily turning off the Repetitive control (button out).
- f) In the Average block of controls, push Time, 8/128, and Shift keys. This starts the averaging process.

Some interesting observations may be made from these results. First, the spectrum photos show a noise reduction of roughly 20 dB, which agrees well with the theoretical value of $10 \log 128$. Second, the noise is not "smoothed" by time averaging; its relative standard deviation appears about the same in both the single and the averaged spectra.

Figure 7. Squarewave plus noise

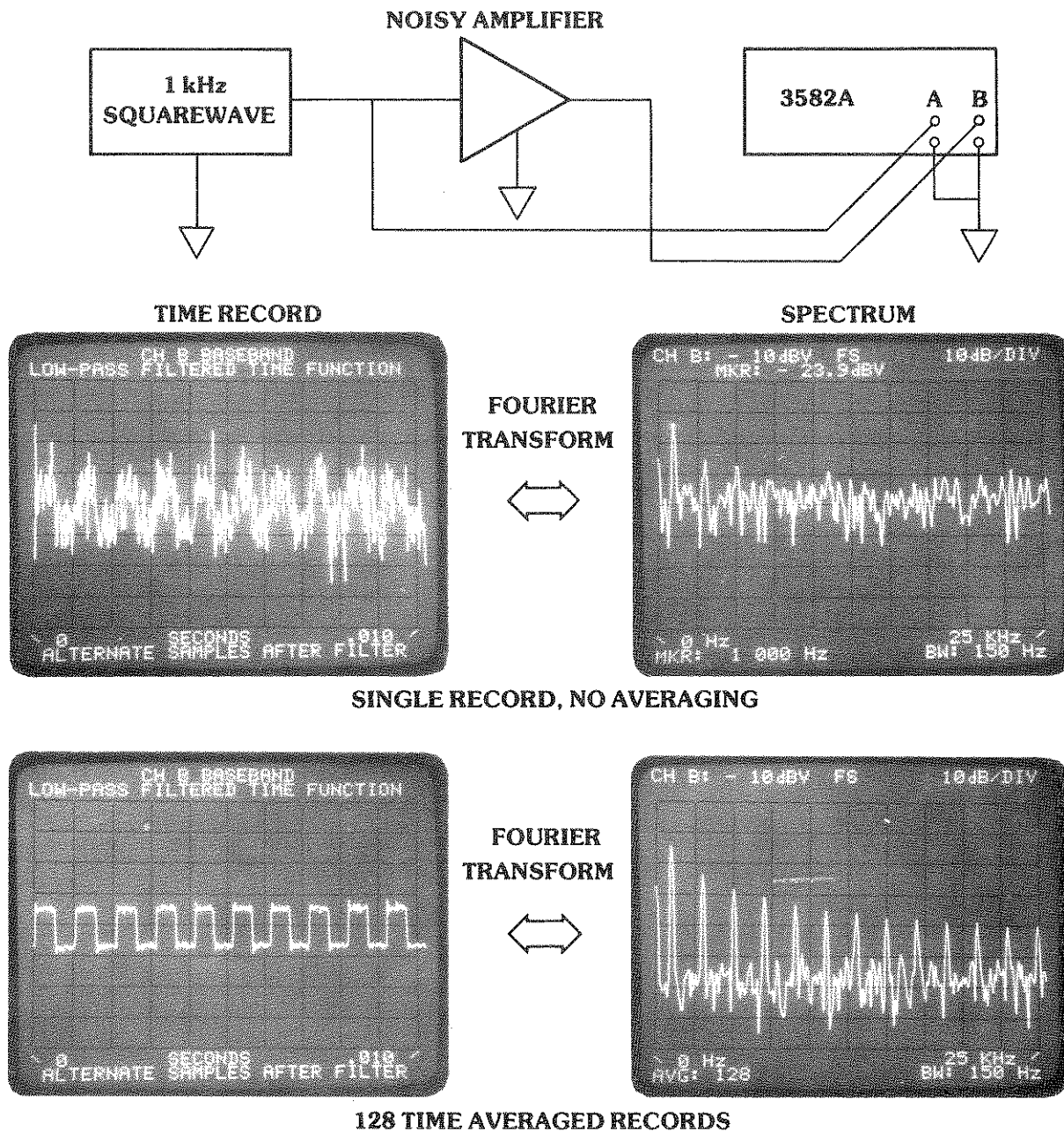

Self-Synchronizing

Sometimes the required synchronizing signal can be derived from the signal to be averaged. This is true when there is a portion of the deterministic waveform which is large compared with the peak noise. Such a situation is shown in Figure 8 which also demonstrates that time averaging can be used with a non-periodic signal. In this case, a tuned circuit is impulsed at irregular intervals, resulting in an identical transient each time. The negative leading edge of the transient was sufficiently higher than the noise to serve as the trigger. Control settings were similar to the previous example, except that Channel A was used for both trigger and analysis, and 32 averages were taken. Also, the uniform passband was used, as is normal with transient analysis. (The uses of the three available passbands are explained in the operating manual.)

A test to see whether a signal can self-trigger in time averaging is to observe the time waveform after some averaging has occurred; if the deterministic waveform seems to diminish or change form as averaging proceeds, there is too much jitter, and a separate trigger must be used.

Example of peak averaging. As we mentioned already, peak averaging is not truly an averaging process; rather, it is a means of comparing successive spectra and saving the largest amplitudes encountered at each analysis frequency.

A popular use of this feature is monitoring the frequency drift of some device which nominally operates at a constant frequency. For instance, a motor's speed may vary due to load, temperature, etc. Using a tachometer as a speed-to-frequency transducer, the peak average routine of the 3582A will reveal the maximum excursions of the speed over the test time.

Figure 8. Transient signal in noisy channel

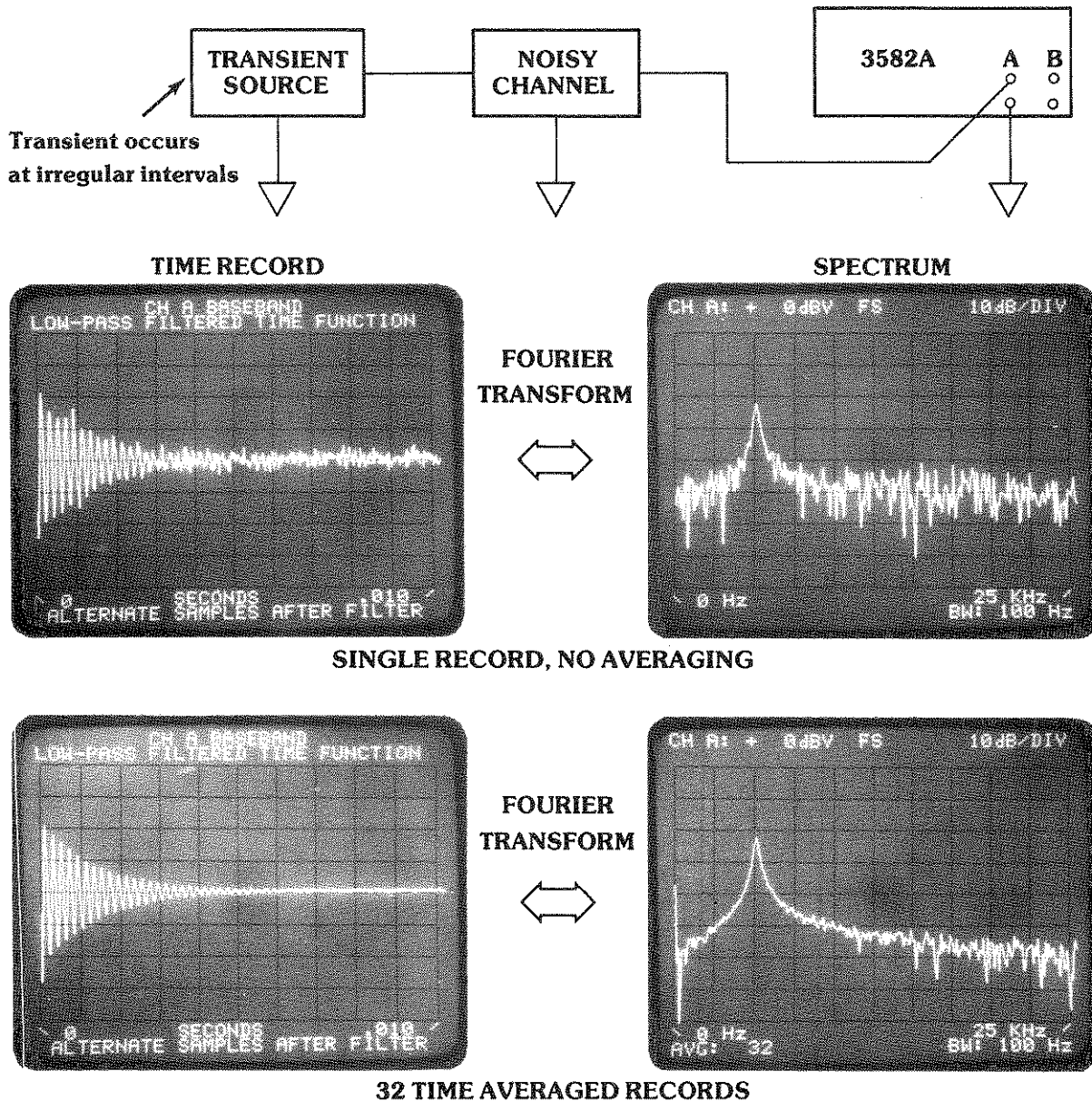

The example used here is similar. An electronic signal generator varies in frequency in a slow, periodic way. When this action is deliberate, it is called a "sweep generator." In Figure 9 such a source is shown connected to the 3582A for analysis of its peak-to-peak frequency excursion. Since the source was a programmable frequency synthesizer whose excursion could be accurately set, the experiment was really intended to check the 3582A. The result, shown in the spectrum photo, is accurate. Using the marker dot would improve the accuracy to 2 Hz resolution.

Some information on the setup is:

- a) The Hanning passband was used, since its narrow peak is more useful for frequency measurements than the broader peak of the flat top passband.
- b) The 3582A was operated to process an unbounded number of spectra; this is done by pressing both 32/EXP and SHIFT keys in the averaging section. When the test was stopped, more than 5000 spectra had been examined.

One word of caution for this kind of measurement: the signal being analyzed should not change frequency too fast, or the analysis will be smeared and inaccurate. A good rule is that the frequency change should not exceed 2% of the analysis span during the time record. For the 3582A, this rule can be formulated:

$$\text{frequency rate-of-change} < \frac{(\text{analysis span})^2}{12500} \text{ Hz/sec}$$

The experiment of Figure 9 met this criterion, since

$$\text{frequency rate} = \frac{2 \times (22150 - 21950)}{33.3} = 12 \text{ Hz/sec}$$

is less than

$$\frac{(500)^2}{12500} = 20 \text{ Hz/sec}$$

The rule is not as restrictive as it sounds. Higher sweep rates cause the appearance of distinct sidebands in the analysis. The frequency excursion can then be calculated from frequency modulation theory. This is beyond the scope of the application note, however.

Figure 9.

Slowly swept source

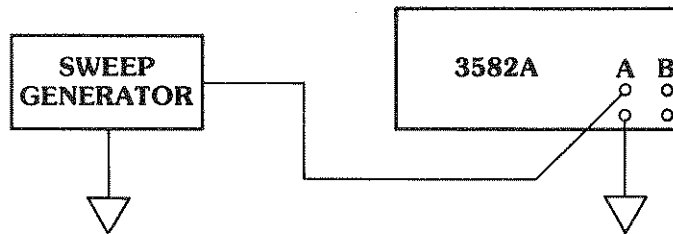

Sweep generator settings:

$$f_{min} = 21950 \text{ Hz}$$

$$f_{max} = 22150 \text{ Hz}$$

$$\text{sweep rate} = 33.3 \text{ sec/sweep}$$

Peak hold "averaged" spectrum

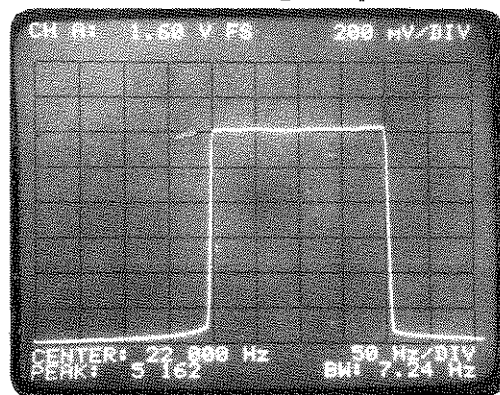

5,162 separate spectra were measured and compared to derive this peak value envelope.

APPENDIX 1:

Probability distributions of power spectrum estimates

Gaussian random processes. If the input time signal to an FFT analyzer is a Gaussian random process, the output frequency variables are also Gaussian. This is because the Discrete Fourier Transform is a **linear** operation on the input. It can be shown that, at each frequency, there are two independent Gaussian random variables, which are the real and imaginary spectral components at that frequency. The two components have zero means and identical variances. From this fact, we conclude that the spectral power is equally divided between the real and imaginary spectral components.

The averaged power spectrum as a random process. The power at any frequency is the sum of the squares of the real and imaginary spectral components. This sum itself is a random process, being a function of two independent random processes. However, the prob-

ability distribution is no longer Gaussian, but "chi-squared." The sum of K independent, zero mean, unity variance, *squared* Gaussian random variables is the chi-squared variable of order K. The square root of the second-order chi-squared variable is called the Rayleigh variable. Hence the magnitude spectrum of the D.F.T. is Rayleigh distributed. In the power spectrum averaging procedure described in Section 3, the average of K spectra is computed from the sum of 2K squared components. From the above discussion, it is apparent that the probability distribution of the sum is chi-squared, of order 2K. Since the chi-squared variable is a standard, tabulated quantity, it is possible to calculate whatever statistical parameters one needs to know. The confidence table below was calculated on the basis of the 0.05 and 0.95 tails of the appropriate chi-squared distribution.

APPENDIX 2:

90% confidence limits for power averages

To use the table, first decide on the allowable statistical tolerance in dB. Then find the number of averages whose 90% limits are within the tolerance bounds. For instance, if we can tolerate a ± 2 dB accuracy band, then the 16-average routine is what we need. Remember that the limits given are statistical, not absolute. That is, they state that, *on the average*, the true value of amplitude will lie within the stated bounds in 9 out of 10 measurements.

	K = number of averages						
	4	8	16	32	64	128	256
Upper limit dB	+4.7	+3.0	+2.0	+1.4	+1.0	+0.7	+0.5
Lower limit dB	-2.9	-2.2	-1.6	-1.2	-0.8	-0.6	-0.4

As an example of use, suppose that a random noise source has been measured, and that 32 spectra have been power averaged. Using the marker readout, the 1000 Hz bin shows a signal level of -55 dBV. The table can be interpreted in this case to indicate that the true signal amplitude has a 90% probability of being in the range of -53.6 dBV to -56.2 dBV.

Bibliography

1. "Random Data: Analysis and Measurement Procedures," J. S. Bendat and A. G. Piersol, John Wiley 1971. This is a fundamental text covering both analog and digital analysis of random processes. Chapters 3 and 4 provide the background for understanding the nature of random processes and measurements made on them. Chapter 6 details the errors encountered in several kinds of measurements on random processes.
2. "Digital Time Series Analysis," R. K. Otne and L. Enochson, John Wiley 1972. This deals specifically with computer analysis of random processes.

MEASURING THE COHERENCE FUNCTION WITH THE HP 3582A SPECTRUM ANALYZER

AN 245-2

FOREWORD

The Fast Fourier Transform algorithm and the development of powerful LSI devices are producing a revolution in the design of signal analyzers. The 3582A Low Frequency Spectrum Analyzer is based on this new technology and provides both greatly increased measurement speed and several kinds of measurement not available in traditional analog instruments.

One of the new measurements available in the 3582A is called the coherence function. If you have encountered problems with noise when measuring transfer functions, the coherence function will help to pinpoint where the difficulty lies. Similarly, if you are trying to determine whether one signal is wholly or partly responsible for an-

other, the coherence function will help because it indicates causality.

Although the coherence function has been a relatively unfamiliar statistical parameter, its usefulness is becoming apparent to the growing number of persons who need to analyze low frequency signals. Having the coherence function internally computed and available for display in the 3582A and similar instruments will, of course, increase interest in understanding its properties. This application note is intended both as an initial contribution to this understanding and as an encouragement to 3582A users to utilize the coherence function in solving their measurement problems.

THE HEWLETT-PACKARD MODEL 3582A SPECTRUM ANALYZER

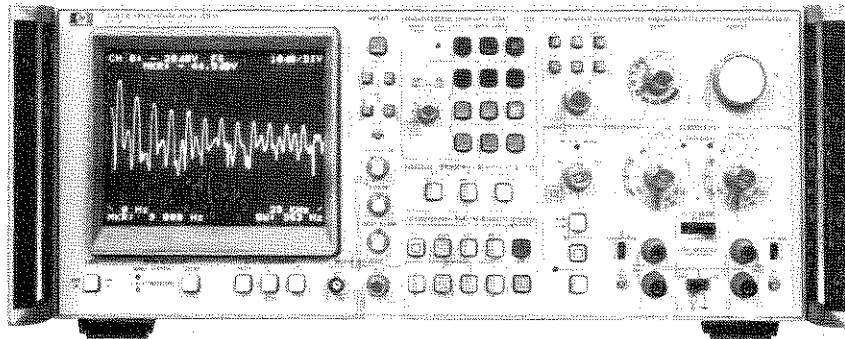

The HP 3582A is a spectrum analyzer covering the frequency range of DC to 25 kHz. Although it is a FFT-based, digital instrument, a special design effort has made it as straightforward to use as a conventional swept analyzer. With dual measurement channels it is possible to measure transfer function gain and phase, as well as the coherence function. A built-in random or pseudo-ran-

dom noise source, whose spectrum tracks the analysis range, is a useful measurement stimulus. Band Selectable Analysis enables narrowband, high resolution analysis to be applied to any portion of the frequency range. The instrument comes equipped with a flexible HP-IB interface for control and two-way data transfers.

TABLE OF CONTENTS

	Page
Section 1: Some system measurement problems	1
Transfer function measurements	
Cause-effect relations	
This section describes two classes of measurements and indicates the role of the coherence function in each.	
Section 2: Introducing the coherence function	2
What is it?	
The role of the coherence function in spectrum averaging	
A note of caution	
Summary of how the coherence function is used	
A brief discussion of the coherence function, its properties and its interpretation is followed by the reasons why it is usually associated with spectrum averaging. A possible problem in interpreting the coherence function is explained.	
Section 3: The coherence function and the 3582A	3
Transfer function measurements	
Causality measurements	
A specific procedure for using the coherence function to assess the validity of measured transfer functions is given. Another procedure is outlined for measurement of the coherence function itself. For each case, 90 percent statistical confidence tables are provided for quantitative interpretation of the measurements.	
Section 4: Experimental examples using the coherence function	5
Example 1: monitoring a transfer function measurement	
Example 2: dual-input system with random signals	
Here are the results of two experiments which illustrate the two principal roles of the coherence function.	
Appendix: Definitions and interpretations	8
Linear spectra and power spectra	
Mathematical definition of the coherence function	
Interpreting the coherence function as a power ratio	
Interpreting the coherence function as a correlation coefficient	
The use of the cross power spectrum to calculate transfer functions	
Mathematical definition and interpretations of the coherence function were left out of the main body of the application note, but are included here for fuller understanding.	
Bibliography	9

Section 1:

Some system measurement problems

Transfer function measurements and the coherence function

Many engineering problems are solved through determining how signals are modified in amplitude and phase as they pass through a system. Transfer function measurement, as this is called, is often made with a network analyzer. This is a specialized instrument which provides a driving signal and can measure the input/output amplitude ratio and phase shift over a band of frequency. Figure 1 shows a typical setup. An excitation signal, such as a swept sinewave or a broadband source, is applied to the input of the system being checked. The system output—its response to the excitation—is measured and the transfer function is calculated. For the calculation, both input and output are in the form of frequency functions.

In "real life" situations, sometimes complications come up which render this kind of measurement inaccurate or even useless. The problem is the presence of additional signals in the output of the system. One kind of disturbing signal is noise, whether internal to the system or external. Another disturbance takes the form of distortion products generated by system nonlinearities. In either case, the disturbing signals affect the accuracy of measuring the linear input/output relation.

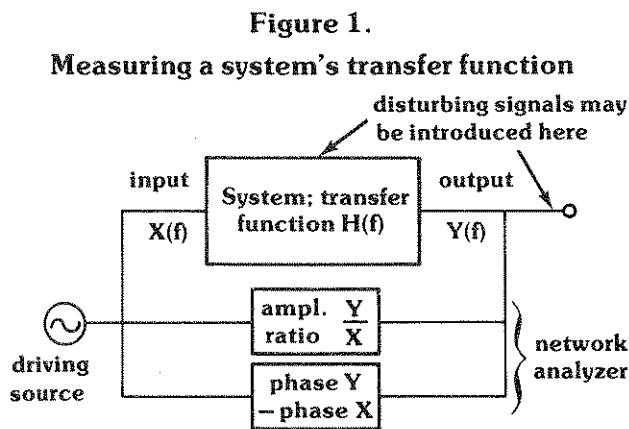

It is evident that determining the transfer function $H(f)$ by calculating the spectral ratio $Y(f)/X(f)$ will lead to irrecoverable errors whenever there is a disturbing signal included with the output $Y(f)$. The 3582A reduces these errors through a computational technique: it uses the cross power spectrum (see appendix) and spectrum averaging. The question remains, however, how many averages are needed to attain a desired accuracy?

Another kind of transfer function problem is the multiple-input system represented by Figure 2. In this case, the signal Y at the output is a composite of energy from several sources X_1, X_2 , etc. This situation may be intentional or unintentional. We want to determine the transfer function from each input to the output; in general, these are not identical. An obvious way to do this is to turn off

all sources and to apply the network analyzer to each path in turn. However, this can't always be done or is often undesirable (vibration measurement on a 4-engine aircraft, for example). Thus, it becomes necessary to measure the desired transfer function in the presence of signals from other sources. The 3582A can perform this measurement, but, again, we have to answer the question of how many spectra must be averaged to achieve a given accuracy.

We shall show in Section 3 how the coherence function may be used to determine the number of averages needed.

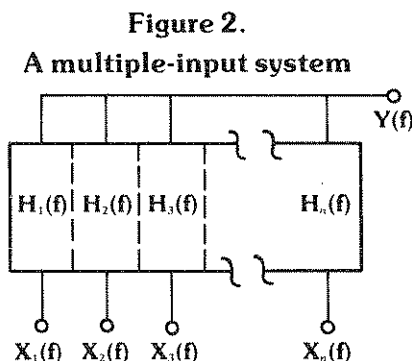

Cause-effect relations and the coherence function

Figure 2 serves as the model for another engineering problem. In this case, the exact shape of the transfer function between any input and the output is not needed. Rather, we are looking for causality; that is, we want to determine how much each source influences the observed output Y . For instance, which machine in a shop is most responsible for the noise at a given location? Which is least responsible? Traditionally, this measurement, when made at all, has relied on determining the cross-correlation function between the suspected source and the output signal Y . The coherence function will also reveal these causality relations, but it has an additional advantage over the cross-correlation function. The cross-correlation function is a function of time, and its maximum value corresponds to the approximate time delay (that is, propagation time) between the source and the observed effect Y . However, the coherence function is a function of frequency, and its maximum values occur at the **frequencies** where the greatest transfer of energy is taking place. The remedies used to suppress interference (noise, vibration, etc.) depend on the frequency distribution of the interference. Therefore, the coherence function not only reveals the degree of causality but is a direct aid in choosing the best means to solve the interference problem.

An example of the use of the coherence function in this application will be given in Section 4.

Section 2: Introducing the coherence function

What is it?

Leaving the mathematical definition for the appendix of this note, we can summarize the important features of the coherence function:

- a) it is a dimensionless, frequency-domain function.
- b) its range of values is 0 to +1.
- c) at **each** frequency, it represents the fraction of the system output power directly related to the input.

With these properties, the coherence function is rather like a cross-correlation function in the frequency domain. (This interpretation is developed in the appendix.) If the system in Figure 1 has no contaminating noise, or there is only one input to the system in Figure 2, the coherence function is +1 at every frequency where there is any output energy.

On the other hand, if $X = 0$ or $H = 0$ at some frequency (so that noise is the only output), the coherence function is zero for that frequency.

When the coherence function is less than unity, at least one of the following conditions exists:

- a) there is noise contaminating the measurement
- b) the system is nonlinear (and generating energy at additional frequencies)
- c) other inputs are present in the system.

The role of the coherence function in spectrum averaging

In reading material on the coherence function, one soon notices that it is almost always discussed and used in the context of spectrum averaging. There are two principal reasons for this. First, in some situations there is unwanted noise contaminating the measurement—such as the transfer function measurement. To compute the transfer function, the 3582A makes use of the cross-power spectrum and relies on averaging to increase the signal-to-noise ratio. The role of the coherence function in this case is to give an indication of how many averages are needed to achieve a given statistical accuracy.

The second reason for the association of the coherence function with spectrum averaging concerns the use of the FFT algorithm. When the FFT is used to calculate the coherence function, a single transform results in a value of unity for the coherence function regardless of its true value. A number of transforms must be averaged to produce a useful (that is, accurate) estimate of the coherence function itself.

For these reasons, the 3582A provides computation and display of the coherence function only in conjunction with the power spectrum averaging routing (called "RMS" averaging on the front panel).

Statistical accuracy vs. instrument accuracy.

In discussing accuracy improvement through averaging, we must point out that we mean **statistical** accuracy and not instrument accuracy. Statistical errors occur because we can measure only a finite sample of a signal. In general, the longer the sample, the smaller is the statistical error. Averaging is one way of measuring a longer sample.

On the other hand, there is always the problem of instrumentation errors. They exist for the traditional reasons of component tolerance, aging, misadjustment, etc., and they are usually not reduced by averaging. So the discussion of the role of the coherence function in accuracy improvement refers only to statistical accuracy.

For further discussion of the use of spectrum averaging in the measurement of noisy or noise-like signals, we refer the reader to the companion Application Note, 245-1 "Signal Averaging With the HP 3582A Spectrum Analyzer."

A note of caution

As useful as the coherence function may be in resolving some of the measurement difficulties mentioned, it is not a panacea. There is one situation in particular in which the user must guard against misinterpreting the information contained in the coherence function. This occurs most commonly in causality measurements and often involves signals at AC powerline frequencies.

For example, suppose the problem is that AC magnetic flux is leaking into a sensitive electronic circuit, and that one of several nearby transformers is suspected to be the culprit. Using appropriate transducers and the 3582A, we measure the coherence function between the circuit and each transformer. **Each** measurement produces a value of +1 at the powerline frequency and several of its harmonics. The experiment is saying that **each** transformer is completely responsible for the interference! This anomaly is caused by the fact that every transformer is wired to the same power source, which is the primary source of the disturbance.

The principle to remember is: if two or more sources are related to (caused by) a primary source, then the coherence function will not reveal the secondary causal relations we want to determine.

This can be a difficult problem in some situations. It can **sometimes** be solved through the more complex techniques of multiple coherences (Ref. 3). Of course, if we can arrange to turn on the sources one at a time, the solution is easy!

Summary of how the coherence function is used

In Section 1 we discussed two broad classes of measurements in which the coherence function has an important role: transfer function measurements and determining causality. The contribution of the coherence function to each of these may be summarized:

- a) Transfer functions. The basic technique used to improve the measurement accuracy is spectrum

averaging. The coherence function is an indicator by which we can determine the number of averaged spectra needed to achieve a desired accuracy.

- b) Causality. At every frequency being analyzed, the coherence function directly indicates causality. Its value is interpreted as the fraction of system output power than can be attributed to the input.

Section 3:

The coherence function and the 3582A

In this section, we outline suggested measurement procedures for the 3582A. Both transfer function and causality measurements are included. There are also tables to help you determine the statistical accuracy of your measurement.

Transfer function measurements

When noise or other signals unrelated to the input are present in the output, the 3582A Transfer Function routine can employ RMS averaging to improve the statistical accuracy. In this note, we use the "90% confidence limit" approach to quantify the accuracy. This means that there is a band of values (given in dB) around each measurement of the transfer function amplitude. The true amplitude will lie within the band in 9 out of 10 measurements **on the average**. For transfer function phase, the idea is the same, but the measurement band is given in degrees.

The following procedure can be used to detect regions of noise contamination and to get acceptable statistical accuracy in measuring the transfer function.

- a) Set up the transfer function routine on the 3582A, using the built-in noise source or another drive signal which covers the frequency range of interest.
- b) Execute 16 or more RMS averages.
- c) Display amplitude and coherence (or phase and coherence).

- d) Use Table 1 to determine whether the measurement is sufficiently accurate in regions where the coherence is low or where high accuracy is desired. If not, more spectra can be averaged by pressing a higher-valued "number of averages" button.
- e) Repeat if necessary.

Causality measurements

For measuring causality the desired result is the value of the coherence function itself. If this is not +1, then some averaging must be performed in order to get a statistically accurate measure of its true value (see Section 2).

This procedure should yield acceptable results:

- a) Set up the coherence measurement on the 3582A, connecting the source being investigated to Channel A and the system output to Channel B.
- b) Execute 16 or more RMS averages.
- c) Display the coherence function. Using Table 2, determine whether the measurement is satisfactory. If not, continue averaging by pressing a higher-valued "number of averages" button.
- d) Repeat as necessary.

Table 1

90% confidence limits on the measurement of the amplitude $|H|$ and phase ϕ of transfer functions, as a function of the measured value of coherence and the number of averages.

Measured value of coherence function	Number of Averages				
	16	32	64	128	256
0.2	+ 5.2 - 14.6 (± 54)	+ 3.8 - 7.1 (± 34)	+ 2.8 - 4.2 (± 23)	+ 2.1 - 2.7 (± 16)	+ 1.5 - 1.8 (± 11)
0.3	+ 4.2 - 8.4 (± 38)	+ 3.1 - 4.8 (± 25)	+ 2.2 - 3.0 (± 17)	+ 1.6 - 2.0 (± 12)	+ 1.2 - 1.4 (± 8)
0.4	+ 3.5 - 6.0 (± 30)	+ 2.6 - 3.6 (± 20)	+ 1.8 - 2.3 (± 14)	+ 1.3 - 1.6 (± 10)	+ 1.0 - 1.1 (± 7)
0.5	+ 3.0 - 4.5 (± 24)	+ 2.1 - 2.8 (± 16)	+ 1.5 - 1.9 (± 11)	+ 1.1 - 1.3 (± 8)	+ 0.8 - 0.9 (± 5)
0.6	+ 2.5 - 3.5 (± 19)	+ 1.8 - 2.2 (± 13)	+ 1.3 - 1.5 (± 9)	+ 0.9 - 1.0 (± 6)	+ 0.7 - 0.7 (± 4)
0.7	+ 2.1 - 2.7 (± 15)	+ 1.5 - 1.7 (± 10)	+ 1.0 - 1.2 (± 7)	+ 0.7 - 0.8 (± 5)	+ 0.5 - 0.6 (± 4)
0.8	+ 1.6 - 2.0 (± 12)	+ 1.1 - 1.3 (± 8)	+ 0.8 - 0.9 (± 6)	+ 0.6 - 0.6 (± 4)	+ 0.4 - 0.4 (± 3)
0.9	+ 1.1 - 1.3 (± 8)	+ 0.8 - 0.8 (± 5)	+ 0.5 - 0.6 (± 4)	+ 0.4 - 0.4 (± 3)	+ 0.3 - 0.3 (± 2)

For each entry, the first two digits are the upper and lower bounds on $|H|$, in dB.

Digits in parentheses are the bounds on ϕ , in degrees.

(Data compiled from formulas in Ref. 3, p. 202.)

Table 2

**90% confidence limits on coherence function measurements.
Entries in table are min, max limits.**

Measured value of coherence function	Number of Averages				
	16	32	64	128	256
0.4	.15, .59	.23, .54	.28, .50	.32, .47	.34, .45
0.5	.25, .67	.33, .63	.39, .59	.42, .57	.45, .55
0.6	.36, .74	.45, .71	.50, .68	.53, .66	.55, .64
0.7	.50, .81	.57, .78	.61, .76	.64, .75	.66, .73
0.8	.65, .88	.70, .86	.74, .84	.76, .83	.77, .82
0.9	.81, .94	.85, .93	.87, .92	.88, .92	.88, .91

Section 4:

Experimental examples using the coherence function

Example 1: Using the coherence function to monitor a transfer function experiment

The purpose of the experiment indicated by Figure 3 is to demonstrate that transfer function measurements are susceptible to contamination by signals other than the intended input, and to show how the coherence function reveals the existence of such signals.

We measured the relative mechanical inertance of a small structure: a 5" by 7" by .062" printed circuit board. Inertance is acceleration/force, and this quantity was measured as a transfer function by connecting an accelerometer output to Channel B and the pseudo-random driving signal to Channel A. (A small shaker converted the electrical driving signal to mechanical force.) Modal vibration resonances are clearly indicated in the inertance spectrum, which is displayed in Figure 3(a) along with the coherence function. Except for zero frequency, where the accelerometer output is zero, the coherence function is unity nearly everywhere else, indicating a good measurement environment (in the sense of signal/noise ratio). One exception occurs at the 100 Hz resonance. Here, the coherence function has decreased to about 0.83, indicating a signal/noise ratio of $.83/1 - .83$, or about 7 dB (see appendix for using the coherence function to calculate a S/N ratio). This effect oc-

curred because, at this frequency, the accelerometer output was low, approaching the noise level of the analyzer.

Without changing anything else, we made a minor modification before running the experiment again. This was to drop a small screw into a hole in the test board. The mass of the screw only slightly lowered the resonant frequencies, but its looseness caused it to vibrate against the board as excitation was applied. Within the experimental structure we thus created a non-linear element which converted (that is, smeared) some of the input energy to other frequencies. As Figure 3(b) shows, not a lot of energy was converted, since the coherence function is generally high. However, at just those places where we would expect signal/noise problems—where the response signal is small—the effect of the smeared energy is apparent. An interesting exception is the strong 260 Hz resonance, which is only lightly affected; this means the energy generated by the vibrating screw is not uniformly distributed in frequency.

The principal use of the coherence function in measurements of this sort is to alert the person performing the measurement that there **is** a signal/noise problem and to give him information about the frequencies and magnitudes of its occurrence.

Figure 3.

Vibration spectrum of 5" x 7" printed circuit board.

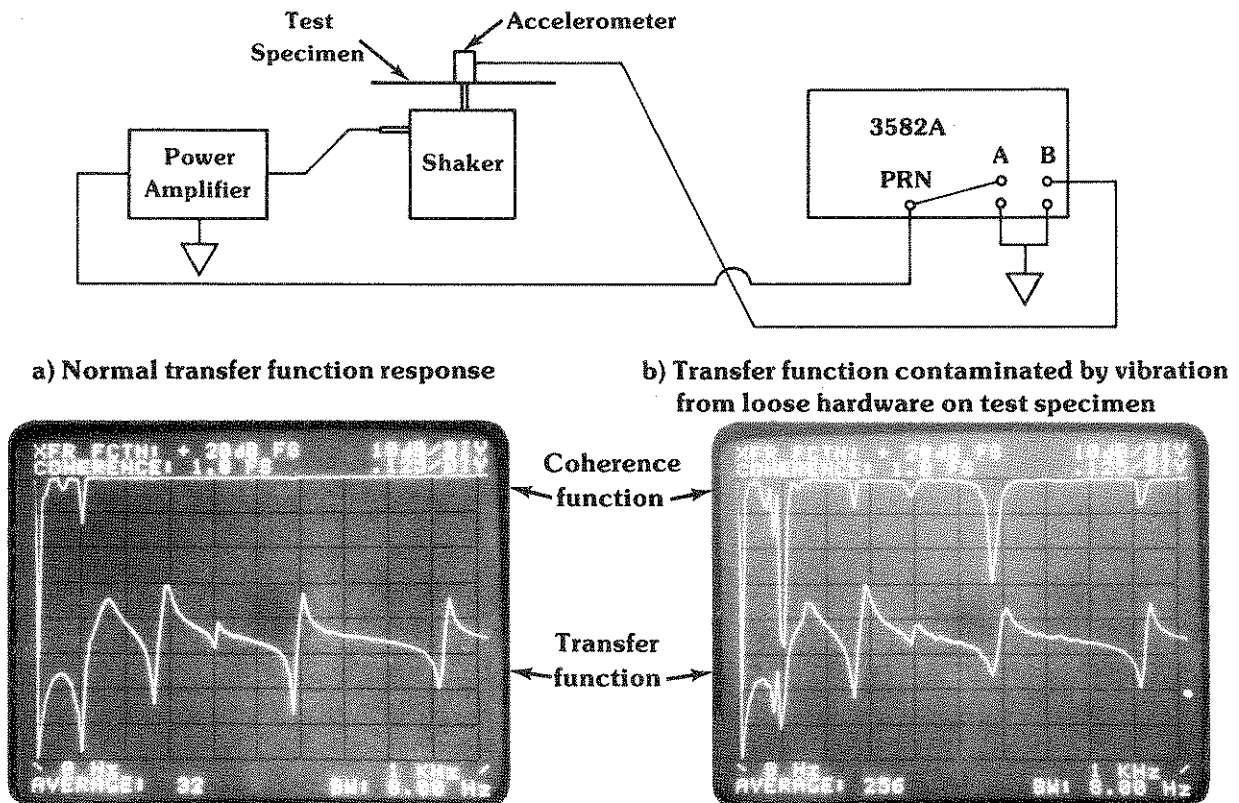

c) Test setup. The “loose hardware,” a 10-32 screw inserted through a hole in the test board, is visible in right front corner of board. Device on top of analyzer is power supply for accelerometer.

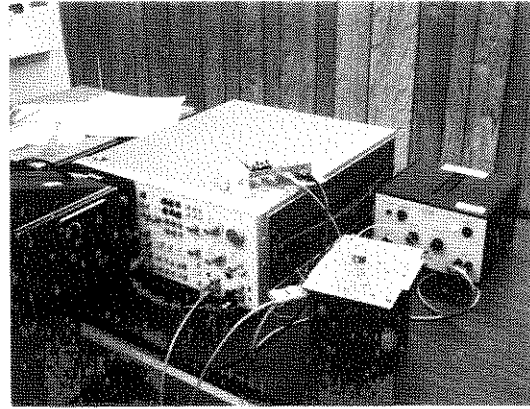

Experiment 2: Dual-input system with random signals

The main purpose of the experiment of Figure 4 is to show how the coherence function is used to separate the individual effects of input signals which are combined in a system to form a common output signal, and thus to reveal input-output causal relations.

Sometimes simple spectrum analysis can be used to trace cause-effect relations. The output signal of a system and an input which is thought to be causally related to it may share common spectral components or lines; this usually means a causal relation unless another input **also** has the same components, which makes the situation a lot more complicated! However, when the spectra are continuous (without individual lines), as is the case with random signals, one cannot usually deduce causality by looking for common components. One purpose of this experiment is to illustrate that point.

In the system shown in Figure 4, there are two identical noise sources, X and Y, connected to the inputs. In

this case, “identical” means that the two power spectra are flat and have the same amplitude, so that they couldn’t be distinguished with a spectrum analyzer. Inside the box representing the system, each signal is passed through a simple filter and then the two are combined linearly to form the output signal. The filters, low-pass and high-pass, are carefully matched in cutoff frequency and gain, with the result that the output signal Z **also** has a flat spectrum, even though it is the combination of two filtered inputs. Figure 4(a) shows the spectra of one of the inputs and the output, while Figure 4(b) shows the filter transfer functions, their -3 dB frequencies being equal. Assuming that we have access only to the terminals X₁, Y₁, and Z, and that we can’t disconnect the sources, how do we determine the causal relation of each source to the output? In fact, how can we tell that this system is any different from one in which there is no frequency dependence in the combining process?

Figure 4.

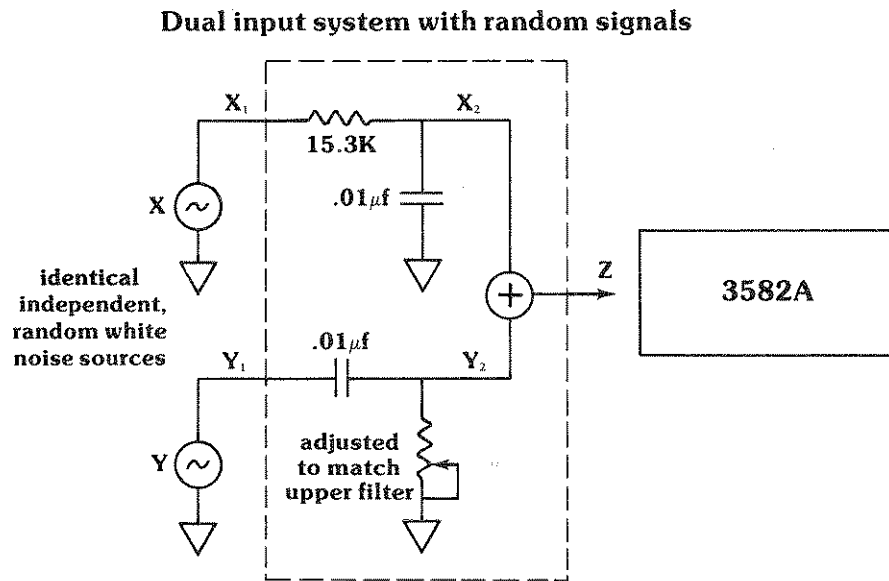

The measured coherence functions, shown in Figure 4(c), provide the answer to these questions. Remembering from the discussion in Section 2 that the measured coherence function of a random process must be averaged to improve the statistical accuracy (which is why the display is ragged; see Table 2), we can interpret the results as follows. First, the low-pass signal X is the dominant output term at low frequencies, since the coherence function is nearly unity there. The same is true for signal Y at high frequencies. At **any** frequency, the two coherence functions add to unity, confirming the statement in Section 2 that the coherence function represents the fraction of output power attributable to the input in question. Note that both functions are equal to 0.5 at the common crossover frequency 1040 Hz (which is often called the half-power point). Finally, the answer to the second question is that the coherence functions for a system with no frequency dependence would be flat, at values which represent each input's contribution to the output power.

a) Noise spectra at one input (X_1) and output Z . The other input (Y_1) has an identical spectrum.

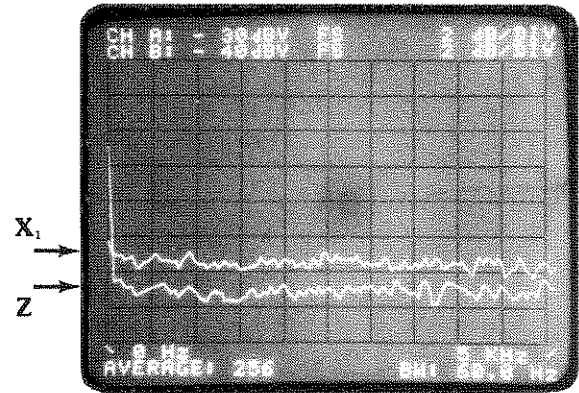

b) Measured filter transfer functions.

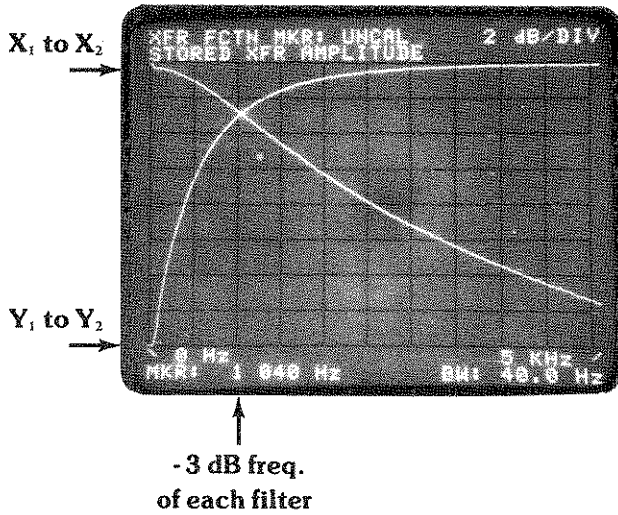

c) Coherence functions between each input and the output.

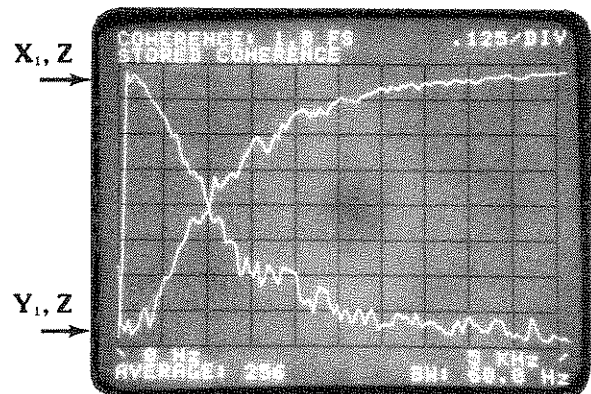

Appendix:

Definitions and interpretations

Linear spectra and power spectra

Figure 5 is the model of a linear, single-input system much like that of Figure 1 except the various signals and the transfer function are shown both as functions of frequency and of time. Also, a single disturbing signal (or noise source) is shown adding to the total output signal Y. This represents the simplest form of the situation described in Section 1, in which the output is contaminated with energy not directly related to the input.

The time-function and frequency-function equivalent forms of a signal are related by the Fourier transform. For instance,

$$X(f) = F[x(t)] \equiv \int_{-\infty}^{\infty} x(t)e^{-j2\pi ft} dt$$

The frequency function $X(f)$ is called a linear spectral function, or linear spectrum because it corresponds to the first order time function $x(t)$. There is another spectral function corresponding to the power function $x^2(t)$. (We assume, for convenience, that $x(t)$ is a voltage across a 1 ohm resistor.) This function is the "auto" power spectrum (that is, self-power) and it is defined as

$$\text{auto power spectrum} = G_{xx}(f) \equiv X(f) \cdot X^*(f)$$

That is, the linear spectrum $X(f)$ multiplied by its complex conjugate. Notice that the power spectrum has no imaginary term; its phase is zero at all frequencies.

There is another kind of power spectrum which reveals, in a sense, the relation between **two** signals, say $X(f)$ and $Y(f)$. This is called the cross-power spectrum, and it is defined similarly:

$$\text{cross-power spectrum} = G_{yx} \equiv Y(f) \cdot X^*(f)$$

In contrast to the auto power spectrum $G_{xx}(f)$, the cross power spectrum is generally complex (phase $\neq 0$).

The cross-power spectrum is central to both the coherence function and the method used by the 3582A to calculate transfer functions.

Figure 5.

Single input, linear system with noise added to output signal

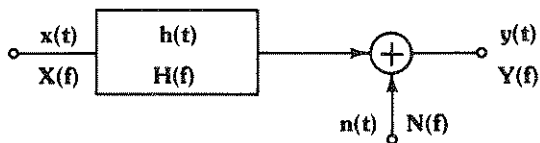

Defining the coherence function

With the concept of a power spectrum in hand, the formal definition of the coherence function, applied to the situation of Figure 5 can be given:

$$\text{coherence function} = \gamma^2 \equiv \frac{|G_{yx}(f)|^2}{G_{xx}(f) \cdot G_{yy}(f)}$$

(From now on, we will drop the independent variable f from the expressions to keep them tidier, but it is assumed.)

The expression for γ^2 , the coherence function, can be examined from at least two points of view which provide useful interpretation and insight.

The coherence function as a power ratio

Note that the output spectrum Y contains both input- and noise-related components: $Y = HX + N$. The power spectrum, G_{yy} , can be expressed using these components:

$$G_{yy} = YY^* = (HX + N)(HX + N)^* = |H|^2 G_{xx} + G_{nn} + HG_{xn} + H^* G_{nx}$$

We can also form an expression for the cross-power term:

$$G_{yx} = YX^* = (HX + N)X^* = HG_{xx} + G_{nx}$$

Now, before using these expanded forms to construct an expression for the coherence function, we must reason as follows: since X and N are assumed to be independent, uncorrelated signals, they do not have any common, synchronous components. Therefore, cross-power terms involving these signals (such as G_{nx}) must be zero. Using this argument, the expanded expression for the coherence function simplifies:

$$\gamma^2 = \frac{(HG_{xx})(HG_{xx})^*}{G_{xx}(|H|^2 G_{xx} + G_{nn})} = \frac{|H|^2 G_{xx}}{|H|^2 G_{xx} + G_{nn}}$$

In words, this interprets the coherence function as

$$\gamma^2 = \frac{\text{output power due to the input}}{\text{total output power}}$$

That is, γ^2 equals the fraction of the output power attributable to the input signal. (Any nonlinearity in the system may convert some of the input signal to energy at other frequencies, but the coherence function treats this energy as noise.) It follows that $\gamma^2 G_{yy}$ is the output power related to the input, and that $(1-\gamma^2)G_{yy}$ is the noise component of the output power. Therefore, the system signal-to-noise ratio is $\gamma^2/1-\gamma^2$. Note that this is not the overall S/N ratio, but the S/N ratio at **each** frequency, a very useful aid in interpreting measurement results.

The coherence function as a correlation coefficient

Another useful interpretation of the coherence function is in terms of the statistical measure called the correlation coefficient.

Let's assume we have N values of each of the complex, zero-mean variables X and Y. (In reality, this is the situation in the 3582A after making N two-channel transforms; **at one frequency**, X_i and Y_i represent the linear spectral values of the i^{th} transform of the signals in channels A and B, respectively.) Estimates of two statistical quantities defined for such variables are

$$1) \text{ the variance: } \sigma_x^2 = \frac{1}{N} \sum_{i=1}^N X_i X_i^*$$

$$\sigma_y^2 = \frac{1}{N} \sum_{i=1}^N Y_i Y_i^*$$

$$2) \text{ the covariance: } C_{yx} = \frac{1}{N} \sum_{i=1}^N Y_i X_i^*$$

Another quantity is the normalized correlation coefficient, defined in terms of (1) and (2) as

3) the normalized correlation coefficient:

$$\rho_{yx} = \frac{C_{yx}}{\sigma_y \sigma_x}$$

Now the 3582A makes these same calculations (1) and (2) in the course of determining the coherence function. That is, at any one of the 256 analysis frequencies, it calculates

$$\text{channel A auto spectrum} = G_{xx} = \frac{1}{N} \sum_{i=1}^N X_i X_i^* = \sigma_x^2$$

And similarly, channel B auto spectrum = $G_{yy} = \sigma_y^2$ and the cross-power spectrum = $G_{yx} = C_{yx}$.

From these results and the previous definition of the coherence function, we see that $\gamma^2 = \rho_{yx}^2$.

Thus, we can interpret the coherence function as the squared correlation coefficient of the two spectra X and Y **at each analysis frequency**.

The use of the cross-power spectrum to calculate transfer functions

On page 2 the use of the cross-power spectrum as a means for calculating transfer functions was mentioned. The reason for this technique will now be outlined.

Referring to Figure 1, it is customary to derive the transfer function H by calculating the output/input ratio Y/X. This is fine, since $Y = HX$, **except** for the situations where Y contains some noise or other contaminating signal. In this case (see Figure 5), the output/input ratio is $(HX + N)/X$, which is not equal to H, nor can any amount of signal averaging cause it to approach the true value of H.

A remedy for this problem can be found as follows. Multiplying numerator and denominator by X^*/X^* , we have

$$\frac{Y}{X} \frac{X^*}{X^*} = \frac{G_{yx}}{G_{xx}} = \frac{HXX^* + NX^*}{XX^*} = \frac{HG_{xx} + G_{nx}}{G_{xx}}$$

As before, we reason that the term G_{nx} is the cross-power between X and N, which are assumed to be uncorrelated. Averaging will thus produce an estimate of this term which tends to zero. Thus, the true value of H is recoverable, even in the presence of system noise, through the use of the cross-power spectrum and the auto spectrum of the input.

Bibliography

The first two references are clearly-written, illustrated technical articles dealing with several aspects (including coherence functions) of random-process measurement. The last is probably the standard text dealing with this subject matter. It is clear and well organized so that it may be used for reference as well as study.

1) "Effective Measurements using Digital Signal Analysis," by Peter R. Roth, IEEE SPECTRUM, April, 1971.

2) "How to Use the Spectrum and Coherence Function," by Peter R. Roth, SOUND AND VIBRATION, January, 1971.

3) "Random Data: Analysis and Measurement Procedures," by Julius S. Bendat and Allan G. Piersol, Wiley-Interscience, 1971.



CATHODE-RAY TUBE WARRANTY AND INSTRUCTIONS

The cathode-ray tube (CRT) supplied in your Hewlett-Packard Instrument and replacement CRT's purchased from HP are warranted by the Hewlett-Packard Company against electrical failure for a period of one year from the date of shipment from Colorado Springs. Broken tubes and tubes with phosphor or mesh burns are not included under this warranty. No other warranty is expressed or implied.

INSTRUCTION TO CUSTOMERS

If the CRT is broken when received, a claim should be made with the responsible carrier. All warranty claims with Hewlett-Packard should be processed through your nearest Hewlett-Packard Sales/Service Office (listed at rear of instrument manual).

INSTRUCTIONS TO SALES/SERVICE OFFICE

Return defective CRT in the replacement CRT packaging material. If packaging material is not available, contact CRT Customer Service in Colorado Springs. The Colorado Springs Division must evaluate all CRT claims for customer warranty, Material Failure Report (MFR) credit, and Heart System credit. A CRT Failure Report form (see reverse side of this page) must be completely filled out and sent with the defective CRT to the following address:

HEWLETT-PACKARD COMPANY
1900 Garden of the Gods Road
Colorado Springs, Colorado 80907

Parcel Post Address:
P. O. Box 2197
Colorado Springs, Colorado 80901

Attention: CRT Customer Service

Defective CRT's not covered by warranty may be returned to Colorado Springs for disposition. These CRT's, in some instances, will be inspected and evaluated for reliability information by our engineering staff to facilitate product improvements. The Colorado Springs Division is equipped to safely dispose of CRT's without the risks involved in disposal by customers or field offices. If the CRT is returned to Colorado Springs for disposal and no warranty claim is involved, write "Returned for Disposal Only" in item No. 5 on the form.

Do not use this form to accomplish CRT repairs. In order to have a CRT repaired, it must be accompanied by a customer service order (repair order) and the shipping container must be marked "Repair" on the exterior.

CATHODE-RAY TUBE FAILURE REPORT

(This form must accompany all warranty claims and MFR/HEART credit claims.)

Date _____

Submitted By (Name) _____

Name of Company _____

Address _____

1. HP Instrument Model No. _____

2. HP instrument Serial No. _____

3. Defective CRT Serial No. _____ Part No. _____

4. Replacement (New) CRT Serial No. _____

5. Please describe the failure and, if possible, show the trouble on the appropriate CRT face below.

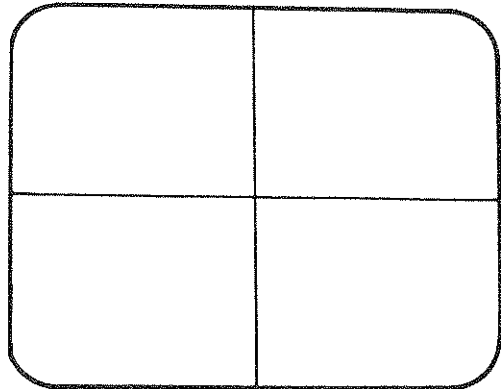
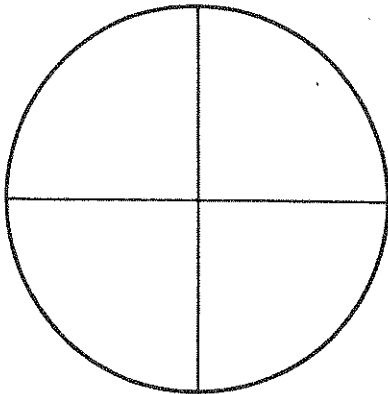

6. Is a warranty claim being made? _____

7. HP Sales/Service Office _____

8. MFR, HEART or Customer Service Order Number _____

SALES & SERVICE OFFICES

AFRICA, ASIA, AUSTRALIA

ANGOLA
Telecha
Empresa Técnica de Equipamentos Eléctricos, S.A.R.L.
R. Barbosa Rodrigues, 42-1 DT.
Caixa Postal, 6467
Luanda
Tel: 255156
Cable: TELECHRA Luanda

AUSTRALIA
Hewlett-Packard Australia Pty. Ltd.
31-41 Joseph Street
Blackburn, Victoria 3130
P.O. Box 36
Doncaster East, Victoria 3109
Tel: 89-8351
Telex: 31-024
Cable: HEWPARAD Melbourne
Hewlett-Packard Australia Pty. Ltd.
31 Bridge Street
Pymble
New South Wales, 2073
Tel: 449-6566
Telex: 21561
Cable: HEWPARAD Sydney
Hewlett-Packard Australia Pty. Ltd.
153 Greenhill Road
Parkside, S.A. 5063
Tel: 272-5911
Telex: 82538 ADEL
Cable: HEWPARAD ADELAID
Hewlett-Packard Australia Pty. Ltd.
141 Stirling Highway
Nelands, W.A. 6009
Tel: 88-5455
Cable: HEWPARAD PERTH
Hewlett-Packard Australia Pty. Ltd.
121 Wollongong Street
Fyshwick, A.C.T. 2609
Tel: 95-2733
Telex: 62650 Canberra
Cable: HEWPARAD CANBERRA
Hewlett-Packard Australia Pty. Ltd.
5th Floor
Teachers Union Building
495-499 Boundary Street
Spring Hill, 4000 Queensland
Tel: 229-1544
Cable: HEWPARAD Brisbane

GUAM
Medical/Pocket Calculators Only
Guam Medical Supply, Inc.
Jay Case Building, Room 210
P.O. Box 8947
Tamuning 96911
Tel: 646-4512
Cable: EARMED Guam

HONG KONG
Schmitt & Co (Hong Kong) Ltd
P.O. Box 297
Connaught Centre
39th Floor
Connaught Road, Central
Hong Kong
Tel: H 25291-5
Telex: 74766 SCHMC HX
Cable: SCHMIDTCO Hong Kong

INDIA
Blue Star Ltd
Kasturi Buildings
Jainstedi Lake Rd
Bombay 400 020
Tel: 29 50 21
Telex: 001-2156
Cable: BLUEFROST
Blue Star Ltd
Sahas
41/2 Vir Savarkar Marg
Prabhadevi
Bombay 400 025
Tel: 45 18 27
Telex: 011-4093
Cable: FROSTBLUE
Blue Star Ltd.
Band Box House
Prabhadevi
Bombay 400 025
Tel: 45 73 01
Telex: 011-3751
Cable: BLUESTAR
Blue Star Ltd
7 Hare Street
P.O. Box 506
Calcutta 700 001
Tel: 23-0131
Telex: 021-7855
Cable: BLUESTAR
Blue Star Ltd
7th & 8th Floor
Bhandari House
91 Nehru Place
New Delhi 110024
Tel: 63470 & 635166
Telex: 031-2463
Cable: BLUESTAR
Blue Star Ltd
7th Floor
Bhandari House
11/11A, Magaraj Road
Bangalore 560 025
Tel: 55668
Telex: 043-430
Cable: BLUESTAR
Blue Star Ltd
Meekashi Mandiran
22/1578 Mahatma Gandhi Rd
Cochin 682 016
Tel: 32069, 32161, 32282
Telex: 0885-514
Cable: BLUESTAR
Blue Star Ltd
1-1-1171
Sarjani Devi Road
Secunderabad 500 003
Tel: 70126, 70127
Cable: BLUEFROST
Telex: 015-459

INDONESIA
BERCA Indonesia P.T.
P.O. Box 496/Jkt
Jl. Kramat Muji 62
Jakarta
Tel: 40369, 49886, 49255, 356038
JKT 42895
Cable: BERCACON
BERCA Indonesia P.T.
63 Jl. Raya Gubeng
Surabaya
Tel: 44309

ISRAEL
Electronics & Engineering Div
of Motorola Israel Ltd
17 Kremenetski Street
P.O. Box 25016
Tel-Aviv
Tel: 38973
Telex: 33569
Cable: BASTEL Tel-Aviv

JAPAN
Yokogawa-Hewlett-Packard Ltd
Ohashi Building
59-1 Yoyogi 1-Chome
Shibuya-ku, **Tokyo** 151
Tel: 03-370-2281/92
Telex: 232-2024YHP MARKET
TOK 23-724
Cable: YHPMARKET
Yokogawa-Hewlett-Packard Ltd
Chuo Bldg., 4th Floor
4-20, Nishinakajima 5-chome
Yodogawa-ku, **Osaka** 532
Tel: 06-394-6021
Yokogawa-Hewlett-Packard Ltd
Nakagyo Building
24 Kami Sasajima-cho
Nakamura-ku, **Nagoya** 450
Tel: (052) 571-5171
Yokogawa-Hewlett-Packard Ltd
Tangawa Building
2-24-1 Tsuruya-cho
Kanagawa-ku
Yokohama 221
Tel: 045-312-1252
Telex: 382-3204 YHP YOK
Yokogawa-Hewlett-Packard Ltd.
Mito Mitsui Building
105, Chome-1 San-no-maru
Mito, Ibaragi 310
Tel: 0292-25-7470
Yokogawa-Hewlett-Packard Ltd
Inoue Building
1348-3, Asahi-cho, 1-chome
Atsugi, **Kanagawa** 243
Tel: 0462-24-0452

KENYA
Technical Engineering Services (E.A.) Ltd.
P.O. Box 18311
Nairobi
Tel: 557726/556762
Cable: PROTON
Medical Only
International Aeradio (E.A.) Ltd.
P.O. Box 19012
Nairobi Airport
Nairobi
Tel: 535055/56
Telex: 22201/22301
Cable: INTAERIO Nairobi

KOREA
Samsung Electronics Co. Ltd
20th Fl. Dongbang Bldg. 250, 2-A
C.P. Box 2775
Taegyeon-Ro, Chung-Ku
Seoul
Tel: (23) 6811
Telex: 22575
Cable: ELEKSTAR Seoul

Malaysia
Teknik Mutu Sdn Bhd
2 Lorong 13/6A
Section 13
Petaling Jaya, **Selangor**
Tel: 54994/54916
Cable: MA 37605
Protel Engineering
P.O. Box 991
Lot 258, Satok Road
Kuching, **Sarawak**
Tel: 2400
Cable: PROTEL ENG

MOZAMBIQUE
A.N. Goncalves, Lda
152, 1. Av. 14 Av. D Lus
Cana Postal 107
Lourenco Marques
Tel: 27091, 27114
Telex: 6-203 NEGON Mo
Cable: NEGON

NEW ZEALAND
Hewlett-Packard (N.Z.) Ltd
P.O. Box 9443
Courtenay Place
Wellington
Tel: 877-1999
Cable: HEWPACK Wellington
Hewlett-Packard (N.Z.) Ltd
Pakuranga Professional Centre
267 Pakuranga Highway
Box 51092
Pakuranga
Tel: 865-621
Cable: HEWPACK Auckland

ANALYTICAL/MEDICAL ONLY
Medical Supplies N.Z. Ltd
Scientific Division
29 Carlton Gore Rd., Newmarket
P.O. Box 1234
Auckland
Tel: 75-289
Cable: DENTAL Auckland
Analytical/Medical Only
Medical Supplies N.Z. Ltd
P.O. Box 1994
147-161 Tery St
Wellington
Tel: 850-799
Telex: 3858
Cable: DENTAL Wellington
Analytical/Medical Only
Medical Supplies N.Z. Ltd
P.O. Box 309
239 Stanmore Road
Christchurch
Tel: 892-019
Cable: DENTAL Christchurch
Analytical/Medical Only
Medical Supplies N.Z. Ltd
303 Great King Street
P.O. Box 233
Dunedin
Tel: 88-817
Cable: DENTAL Dunedin

NIGERIA
The Electronics Instrumentations Ltd
NBB-775 Gyo Road
Oluseun House
P.M.B. 5402
Ibadan
Tel: 61577
Telex: 31231 TEIL Nigeria
Cable: THETEIL Ibadan
The Electronics Instrumentations Ltd
144 Agege Motor Road, Mushin
P.O. Box 6645
Lagos
Cable: THETEIL Lagos
PAKISTAN
Musko & Company, Ltd
Oosman Chambers
Abdullah Haroon Road
Karachi 3
Tel: 511027, 512927
Telex: 2894
Cable: COOPERATOR Karachi
Musko & Company, Ltd
38B Satellite Town
Rawalpindi
Tel: 41924
Cable: FEMUS Rawalpindi

PHILIPPINES
The Online Advanced Systems Corporation
Rico House
Ampiroso cor. Herrera Str
Legaspi Village, **Makati**
Manila
Tel: 85-35-81, 85-34-91
Telex: 3274 ONLINE

RHODESIA
Field Technical Sales
45 Kelvin Road North
P.O. Box 3458
Salisbury
Tel: 705231 (5 lines)
Telex: RH 4122
SINGAPORE
Hewlett-Packard Singapore
(Pte.) Ltd
1150 Doral Road
Alexandra P.O. Box 58
Singapore 4
Tel: 270-2355
Telex: HPSG RS 21486
Cable: HEWPACK Singapore
SOUTH AFRICA
Hewlett-Packard South Africa
(Pty.) Ltd
Private bag Wendywood
Sandton, Transvaal 2144
Hewlett-Packard Centre
Daphne Street, Wendywood
Sandton, Transvaal 2144
Tel: 802-10408
Telex: 8-4792
Cable: HEWPACK JOHANNESBURG
Service Department
Hewlett-Packard South Africa
(Pty.) Ltd
P.O. Box 39325
Graham, Sandton, 2018
451 Wynberg Extension 3
Sandton, 2601
Tel: 636-8188/9
Telex: 8-2391
Hewlett-Packard South Africa
(Pty.) Ltd
P.O. Box 120
Howard Place, Cape Province, 7450
Pine Park Centre, Forest Drive,
Pinecliffs, Cape Province, 7405
Tel: 35-7955 thru 9
Telex: 57-0006
Service Department
Hewlett-Packard South Africa
(Pty.) Ltd
P.O. Box 27099
Queensport, Durban 4067
Durban, 4001
Tel: 88-7478
Telex: 6-7954

TAIWAN
Hewlett-Packard Far East Ltd.
Tawan Branch
39 Chung Hsiao West Road
Sec. 1, 7th Floor
Taipei
Tel: 3819160-4
Cable: HEWPACK TAIPEI
Hewlett-Packard Far East Ltd.
Tawan Branch
88-2, Chung Cheng 3rd. Road
Kaohsiung
Tel: (07) 242318-Kaohsiung
Analytical Only
San Kwang Instruments Co., Ltd.
No. 20, Yang Sun Road
Taipei
Tel: 371571-4 (5 lines)
Telex: 22894 SANKWANG
Cable: SANKWANG TAIPEI

TANZANIA
Medical Only
International Aeradio (E.A.) Ltd.
No. 20, Young Sun Road
Dar es Salaam
Tel: 21251 Tel. 265
Telex: 41030
THAILAND
UNIMESA Co. Ltd.
Elcom Research Building
2538 Sukhumvit Ave.
Bangkok
Tel: 3932087, 3930338
Cable: UNIMESA Bangkok

UGANDA
Medical Only
International Aeradio (E.A.) Ltd.,
P.O. Box 2577
Kampala
Tel: 54388
Cable: INTAERIO Kampala

ZAMBIA
R. Tabori (Zambia) Ltd
P.O. Box 2792
Lusaka
Tel: 73793
Cable: ARJAYTEE Lusaka

OTHER AREAS NOT LISTED, CONTACT:
Hewlett-Packard International
3200 Hillview Ave.
Palo Alto, California 94304
Tel: (415) 493-1501
TWX: 910-373-1267
Cable: HEWPACK Palo Alto

CANADA

ALBERTA
Hewlett-Packard (Canada) Ltd
11828A - 186th Street
Edmonton T5M 3T9
Tel: (403) 452-3670
TWX: 610-831-2431
Hewlett-Packard (Canada) Ltd.
210, 7220 Fisher St. S E
Calgary T2H 2H8
Tel: (403) 253-2713
TWX: 610-821-6141

BRITISH COLUMBIA
Hewlett-Packard (Canada) Ltd
837 E. Gordiva Street
Vancouver V6A 3R2
Tel: (604) 254-0531
TWX: 610-922-5059

MANITOBA
Hewlett-Packard (Canada) Ltd
513 Century St
Winnipeg R3H 0L8
Tel: (204) 786-7581
TWX: 610-671-3531

NOVA SCOTIA
Hewlett-Packard (Canada) Ltd
800 Windmill Road
Halifax B3B 1L1
Tel: (902) 469-7820
TWX: 610-271-4482 HFX

ONTARIO
Hewlett-Packard (Canada) Ltd
1820 Morrison St
Ottawa K2H 8K7
Tel: (613) 820-6483
TWX: 610-563-1636
Hewlett-Packard (Canada) Ltd
6877 Goreway Drive
Mississauga L4V 1M8
Tel: (416) 679-9436
TWX: 610-492-4246

QUEBEC
Hewlett-Packard (Canada) Ltd
275 Hymus Blvd
Pointe Claire H9R 1G7
Lima 1
Tel: 41-4325
Cable: ELMED Lima
Tel: 610-422-3622
TWX: 610-422-3622
Tel: 610-821521 HPCL

FOR CANADIAN AREAS NOT LISTED:
Contact Hewlett-Packard (Canada)
Ltd. in Mississauga

CENTRAL AND SOUTH AMERICA

ARGENTINA
Hewlett-Packard Argentina
S.A.
Av. Leandro N Alem 822 - 12
1001 Buenos Aires
Tel: 31-8063, 4, 5, 6 and 7
Telex: 122443 AR CIGY
Cable: HEWPACK ARG
BOLIVIA
Casa Kavlin S.A.
Calle Potosi, 1130
P.O. Box 500
La Paz
Tel: 41530, 53221
Telex: CWC BX 5298, ITT 3560082
Cable: KAVLIN
BRAZIL
Hewlett-Packard do Brasil
I. e. C. Ltda
Avenida Rio Negro, 980
Alphaville
06400 Barueri SP
Tel: 429-3222

Hewlett-Packard do Brasil
I. e. C. Ltda.
Rua Padre Chagas, 32
30000-Porto Alegre-RS
Tel: (0512) 22-2998, 22-5821
Cable: HEWPACK Porto Alegre
Hewlett-Packard do Brasil
I. e. C. Ltda.
Rua Siqueira Campos, 53
Cocabanaba
20000-Rio de Janeiro
Tel: 257-90-94, DDO (021)
Telex: 391-212-1905 HEWP-BR
Cable: HEWPACK
Rio de Janeiro
CHILE
Calcani y Metcalfe Ltda
Alameda 580-01 807
Casilla 2118
Santiago, 1
Tel: 398513
Telex: 3520001 CALMET
Cable: CALMET Santiago

COLOMBIA
Instrumentacion
Henrik A. Langebek & Kjel S.A.
Carrera 7 No. 46-75
Apartado Aéreo 6267
Bogota, I. D. E.
Tel: 659-88-27
Cable: AARIS Bogota
Telex: G44-400
COSTA RICA
Cienciahica Costarricense S.A.
Avenida 2, Calle 5
San Pedro de Montes de Oca
Apartado 10159
San Jose
Tel: 24-38-20, 24-08-19
Telex: 2367 GALGUR CR
Cable: GALGUR

ECUADOR
Calculators Only
Computadoras y Equipos
Electrónicos
Avenida 308 R.L.1
Elfly Altiro #1824.3 Piso
Quito
Tel: 453482
Telex: 02-2113 Sagita Ed
Cable: Sagita-Quito
EL SALVADOR
Instrumentacion y Procesamiento
Electronico de el Salvador
Bulevar de los Heroes 11-48
San Salvador
Tel: 252787
GUATEMALA
IPESA
Tel: 22-2113 Sagita Ed
Cable: Sagita-Quito
Guatemala City
Tel: 53627, 64786
Telex: 4192 Teletro Gu

MEXICO
Hewlett-Packard Mexicana
S.A. de C.V.
Av. Penhéro Sur No. 6501
Tepicpan, Xochimilco.
Mexico 23, D.F.
Tel: 905-876-4600
Hewlett-Packard Mexicana
S.A. de C.V.
Ave. Constitución No. 2184
Monterrey, N.L.
Tel: 481-31-32, 48-71-84
Telex: 038-410
NICARAGUA
Roberto Terán G.
Apartado Postal 689
Edificio Terán
Managua
Tel: 2114, 23412, 23454
Cable: ROTERAN Managua
PANAMA
Electrónico Balboa, S.A.
P.O. Box 4929
Calle Samuel Lewis
Colon, Panama
Tel: 641-2700
Telex: 3483103 Cufunda
Canal Zone
Cable: ELECTRON Panama

PERU
Compañía Electro Médica S.A.
Los Flamencos 145
San Isidro Casilla 1030
Lima 1
Tel: 41-4325
Cable: ELMED Lima
PUERTO RICO
Roberto Terán G.
Puerto Rico Branch Office
Calle 272
No. 203 Urb. Country Club
Carolina 00924
Tel: (809) 762-7255
Telex: 345 0514
URUGUAY
Pablo Ferrando S.A.
Comercial e Industrial
Avenida Italia 2817
Casilla de Correo 370
Montevideo
Tel: 49-3102
Cable: ELECTRON Montevideo

VENEZUELA
Hewlett-Packard Intercontinental
P.O. Box 50933
Caracas 105
Los Ruices Norte
3a Transversal
Edificio Serey
Caracas 107
Tel: 35-00-11 (20 lines)
Telex: 25146 HEWPACK
Caracas
FOR AREAS NOT LISTED, CONTACT:
Hewlett-Packard Inter-American
3200 Hillview Ave.
Palo Alto, California 94304
Tel: (415) 493-1501
TWX: 910-373-1260
Cable: HEWPACK 034-8493

